

INSTALLATION GUIDE FOR THE E-ACLM-3P480 3 Phase Power Monitor

INTRODUCTION

The E-ACLM-3P480, 3-Phase AC Voltage and/or Current Monitor, monitors and reports the True RMS Voltage, RMS Current, Frequency, Active Power, Reactive Power, Phase Angle, Power Factor and Apparent Power for any 3-phase circuit, such as the power a building consumes. When used in conjunction with an E-16D, -5D or -2D Enterprise Environment Monitoring System (SYSTEM) the user can configure the ENVIROMUX web interface to alert users of changing conditions.

Features:

- Reports True RMS Voltage, RMS Current, Active Power, Reactive Power, Frequency, Phase Angle, Power Factor and Apparent Power.
 - RMS Voltage, RMS Current, Active Power, Reactive Power, Phase Angle, Power Factor and Apparent Power are each measured and reported on a per phase basis
 - Monitors one single or three-phase circuit (not multiple independent single-phase circuits)
 - Current and power measurements require current transformers (sold separately).
 - Measurement update rate is once per second (via software).
- Common applications include: electrical systems, power equipment, generators, remote sites, controlled environment vaults (CEVs), building automation, data center, cabinets, telecom, substations, storage power supplies, communication huts, indoor/outdoor lighting, power distribution, and medical and test equipment.
- Three 2-wire terminal blocks provided for easy attachment of optional current transformers with 16-26AWG wires (sold separately)
 - The use of Split-core current transformers allows installation without disconnecting conductors.
 - Accuracy and range are current transformer-dependent.
- Input primary voltage: Up to 552 VAC RMS, 2000VDC Isolated
 - 4-wire terminal block provided for bare-wire or crimp terminal attachment of primary voltage sample
- Frequency: 50/60Hz
- Maximum primary current: limited only by the current transformer used
- Powered by E-2D/5D/16D
- Controlled and monitored through the E-2D/5D/16D firmware (version 2.43 or later) and associated MIB file
- Dimensions WxDxH (in): 6.82x3.0x1.725 (173x76x44 mm).
- Supports 24AWG CAT5/5e/6 cable up to 300 ft (91 m).
- Regulatory approvals: CE, RoHS.
- How to install: voltage inputs tie directly into the line. Caution: should be installed by qualified electricians only.
 - Make sure electrical service is disconnected before making any electrical connections.
- Compatible with [E-FSC](#) Fiber Converter/Extender.
 - Use to extend sensor up to 1.2 miles (2 km) from the ENVIROMUX unit.

Note: The E-xD must be running firmware version 2.43 or later in order to use the E-ACLM-3P480 with it. To view all supported sensors, version 3.0 or later must be running. Refer to the E-xD manual for firmware upgrade instructions as needed.

Current Transformers Available:

Model	Rated Current	Loop Diameter
E-CT50-SC10	50A	0.39" 10mm
E-CT100-SC16	100A	0.63" 16mm
E-CT250-SC24	250A	0.94" 24mm
E-CT500-SC36	500A	1.42" 36mm

INSTALLATION

Mount the E-ACLM-3P380 using the mounting ears provided. To use the ears, remove the screws securing the ears to the rear of the E-ACLM-3P480, turn the ears around, and reapply the screws.

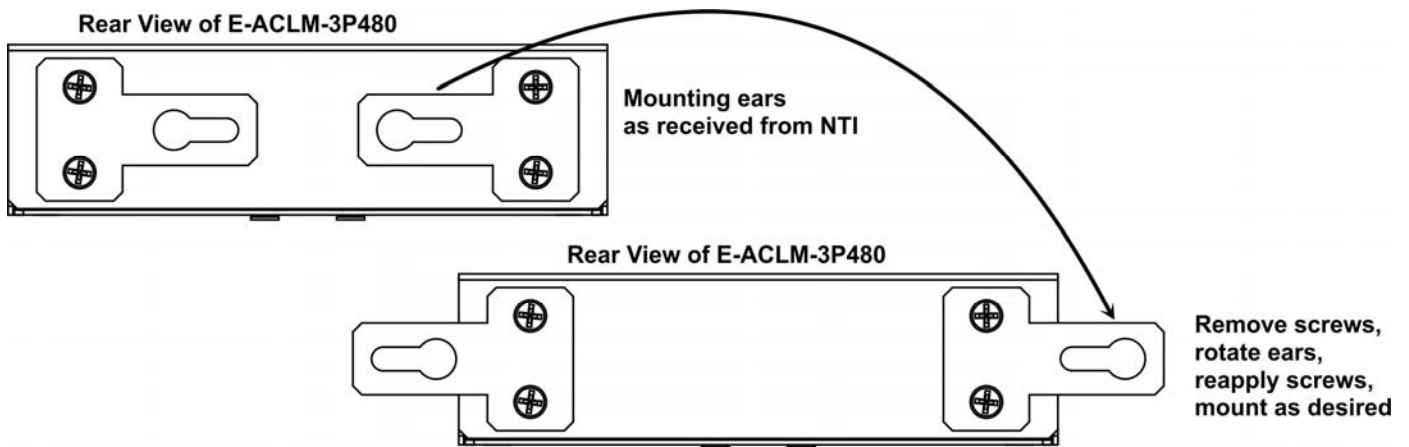

To mount multiple E-ACLM-3P480 in close proximity to the E-16D, install an extension rail kit (NTI E-RL-16D - sold separately) and mount E-ACLM-3P480 as seen in the illustration below.

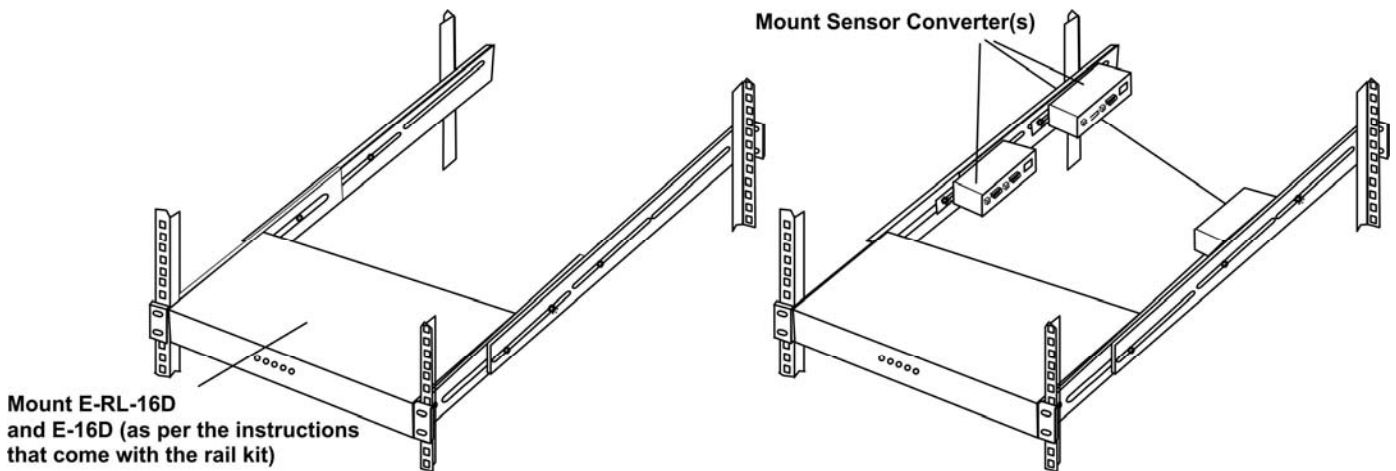

POWER

The E-ACLM-3P480 operates at 5VDC and is powered through the CATx cable connected to the RJ45 Sensor port on the E-16D/5D/2D.

MONITORING CONNECTIONS

Note: To prevent damage to the voltage source or the Sensor Adapter proper polarity must be observed when making connections.

1. At the "AC VOLTAGE" terminal block, connect a voltage source to be monitored using 16-24AWG wire rated for at least 600 volts.
2. If current sensing is desired, install current transformers (sold separately) to the circuit(s) to be monitored. Orient the transformers such that the wires exit the current transformers towards the load side of the circuit. Then connect the attached 2-wire cables to the sensor at one of the "AC CURRENT TRANSFORMER" terminals, black to negative, white to positive.

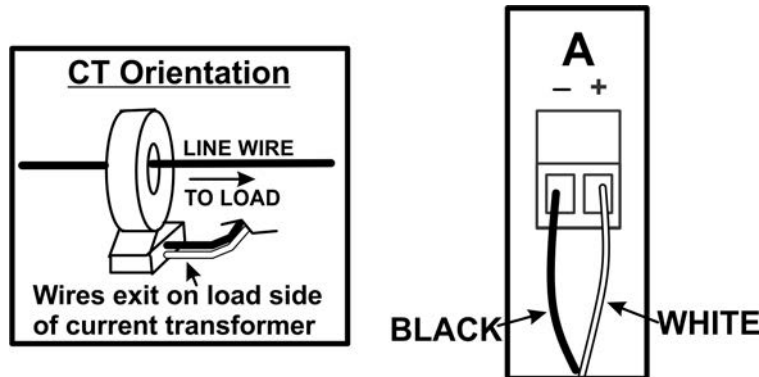

Note: If the displayed "Active Power" and "Reactive Power" values for a phase are the inverse of what you expect to see (negative instead of positive, or, positive instead of negative), you can either A) disconnect, rotate 180° and reinstall the current transformer with the wire passing through in the opposite direction, or B) disconnect the two wires for that current transformer from the "AC CURRENT TRANSFORMER" terminals and reverse them.

When placing a split core CT (i.e. E-AMP30-SC21) around a conductor, make sure the CT core is large enough to be placed completely around the conductor and is closed in order to sense current properly.

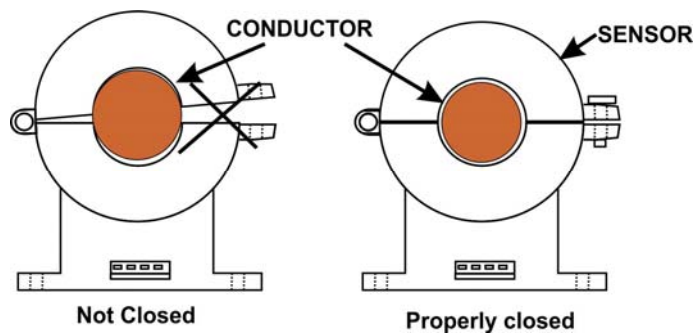

Active Power Readings:

If the displayed "Active Power" and "Reactive Power" values for a phase are the inverse of what you expect to see (negative instead of positive, or, positive instead of negative), you can either A) disconnect, rotate 180° and reinstall the current transformer with the wire passing through in the opposite direction, or B) disconnect the two wires for that current transformer from the "AC CURRENT TRANSFORMER" terminals and reverse them.

Reactive Power Reading:

The Reactive Power readings are an indication of the inductive or capacitive load of the device you are monitoring. This value can be either positive or negative.

If it is negative it means the current phase is leading the voltage phase in the device which translates to a capacitive load.

If it is positive it means the current phase is lagging the voltage phase in the device and translates to an inductive load.
Note: If the load is purely resistive then the reactive power value will be zero.

A chassis (earth) ground terminal is provided for application of a safety earth ground wire.

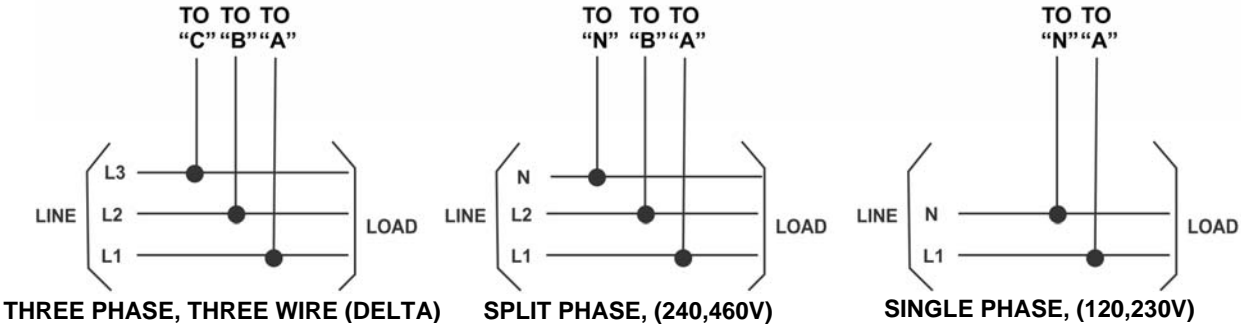
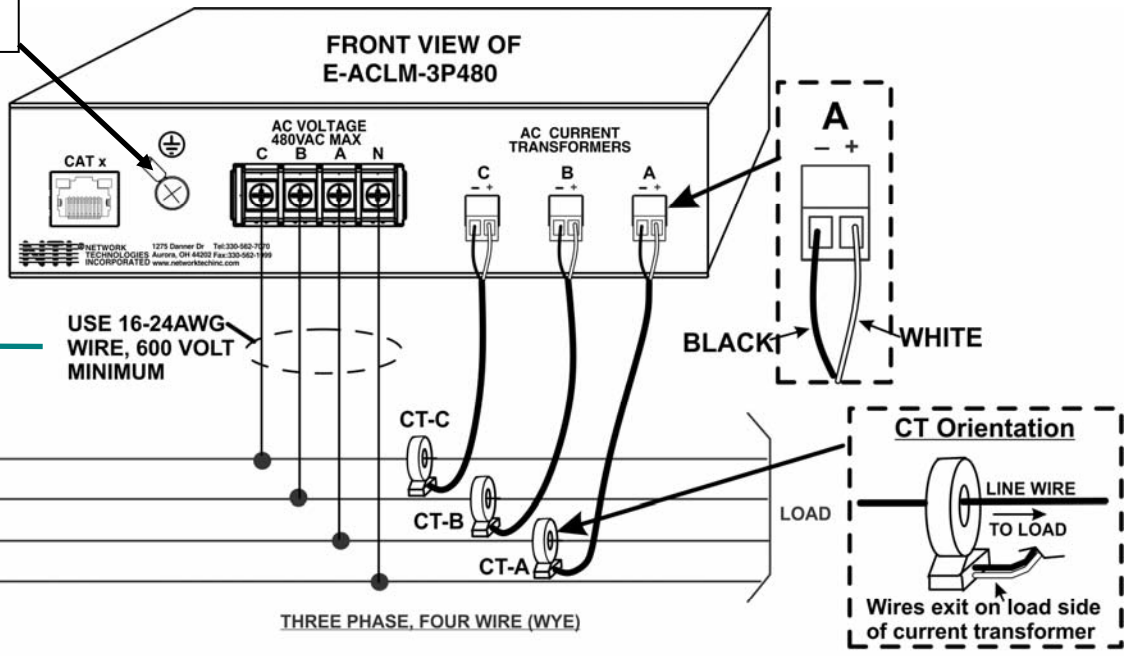

Other similar products require fuse protection on the wires for AC Line Voltage connection because they use those connections as a source of power. The E-ACLM-3P480 gets all power to operate from the E-xD through the CATx cable and only uses the AC Line Voltage connections for high-impedance sensing.

Note:
 If the displayed "Active Power" and "Reactive Power" values for a phase are the inverse of what you expect to see (negative instead of positive, or, positive instead of negative), you can either A) disconnect, rotate 180° and reinstall the current transformer with the wire passing through in the opposite direction, or B) disconnect the two wires for that current transformer from the "AC CURRENT TRANSFORMER" terminals and reverse them.

The wires that connect the current transformer to the E-ACLM-3P480 can be extended up to a total of 10ft. using straight 22AWG wire. Longer extensions (up to 100ft.) may require twisted pair wires, shielded wires, or runs through conduit depending on how much electromagnetic interference is in the environment.

TIP: A single current transformer can be used to measure current at different ranges. By passing a wire through the sensor loop repeatedly (looping the wire around), the range of the unit will be divided by the number of times the wire passes through. For a 100A sensor, for example, two passes will reduce it by 100/2 (range of 0-50A), three passes will reduce it by 100/3 (range of 0-33A), and so on. See example below. If you need to increase the sensitivity of your current transformer, this is a way to do so. Be sure to adjust the value of your “Nominal Range” when configuring the “RMS AC Current” (page 6) in accordance with the adjusted range of the current transformer.

100A Current Transformer

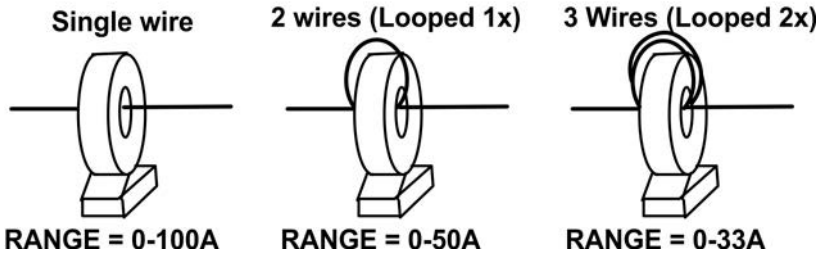

3. Connect a 24AWG CAT5/5e/6 patch cable (up to 300 feet long) between the “Cat x” port on the E-ACLM-3P480 and an “RJ45 Sensor” port on the SYSTEM. (The use of smaller gauge CATx cabling will result in shorter distances that can be spanned.)

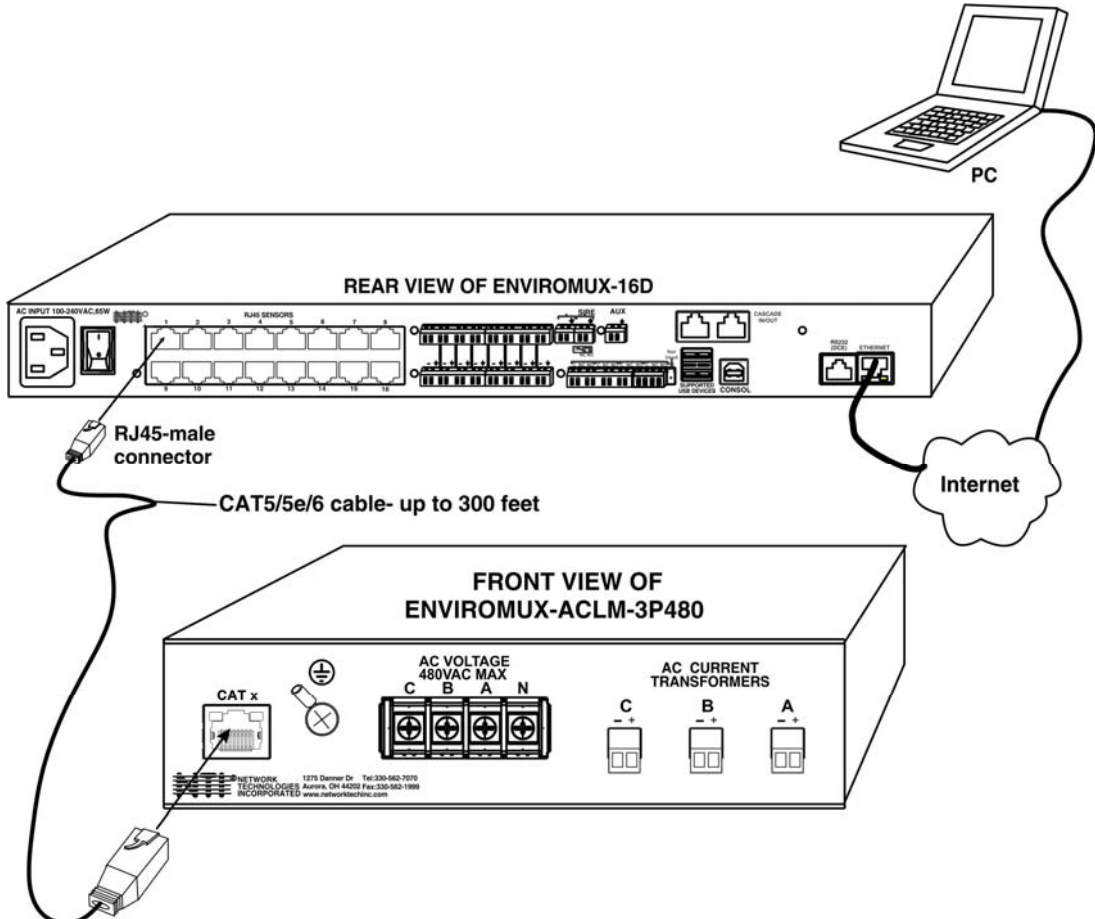

4. Configure the SYSTEM to react to changes in the voltage and/or current from the source, as desired. See examples on the following pages.

CONFIGURATION

Sensors					
Conn.	Description	Type	Value	Status	Action
14.1	Lab Air Compressor Phase A Voltage	RMS AC Voltage	118.4V	Normal	View Edit Delete
14.2	Lab Air Compressor Phase A Current	RMS AC Current	31.4A	Normal	View Edit Delete
14.3	Lab Air Compressor Phase A Power	Active Power	-3319.4W	Normal	View Edit Delete
14.4	Lab Air Compressor Phase A Reactive Power	Reactive Power	-1648.6VAR	Normal	View Edit Delete
14.5	Lab Air Compressor Phase B Voltage	RMS AC Voltage	119.0V	Normal	View Edit Delete
14.6	Lab Air Compressor Phase B Current	RMS AC Current	32.3A	Normal	View Edit Delete
14.7	Lab Air Compressor Phase B Power	Active Power	-3383.8W	Normal	View Edit Delete
14.8	Lab Air Compressor Phase B Reactive Power	Reactive Power	-1812.3VAR	Normal	View Edit Delete
14.9	Lab Air Compressor Phase C Voltage	RMS AC Voltage	119.1V	Normal	View Edit Delete
14.10	Lab Air Compressor Phase C Current	RMS AC Current	32.7A	Normal	View Edit Delete
14.11	Lab Air Compressor Phase C Power	Active Power	-3484.4W	Normal	View Edit Delete
14.12	Lab Air Compressor Phase C Reactive Power	Reactive Power	-1711.8VAR	Normal	View Edit Delete
14.13	Lab Air Compressor Frequency	Frequency	60.0Hz	Normal	View Edit Delete
14.14	Lab Air Compressor Phase Angle Phase A	Phase Angle	-153.2°	Normal	View Edit Delete
14.15	Lab Air Compressor Phase Angle Phase B	Phase Angle	-151.6°	Normal	View Edit Delete
14.16	Lab Air Compressor Phase Angle Phase C	Phase Angle	-153.4°	Normal	View Edit Delete
14.17	Lab Air Compressor Power Factor Phase A	Power Factor	-0.9	Normal	View Edit Delete
14.18	Lab Air Compressor Power Factor Phase B	Power Factor	-0.9	Normal	View Edit Delete
14.19	Lab Air Compressor Power Factor Phase C	Power Factor	-0.9	Normal	View Edit Delete
14.20	Lab Air Compressor Apparent Power Phase A	Apparent Power	3715.6VA	Normal	View Edit Delete
14.21	Lab Air Compressor Apparent Power Phase B	Apparent Power	3844.2VA	Normal	View Edit Delete
14.22	Lab Air Compressor Apparent Power Phase C	Apparent Power	3890.4VA	Normal	View Edit Delete

When an E-ACLM-3P480 is connected to the SYSTEM, the summary page (above- from the SYSTEM web interface) will update with 3 sets of 4 different sensor types, RMS AC Voltage, RMS AC Current, Active Power and Reactive Power. The sensor is plugged into RJ45 Sensor port #2 in this example. Numbers "1a", "1b", "1c" correspond to the letters A-C on the E-ACLM-3P480 for connected AC Voltage and Current sources. Click on the Sensor in the Description column (or "View" under Action) and display the status page for each sensor. (Below). In order to better define the sensor on the Summary Page, in SNMP traps, or in a MIB browser, click on the "Edit" link to open the sensor configuration page and configure the sensor.

Sensor #1.1a Status

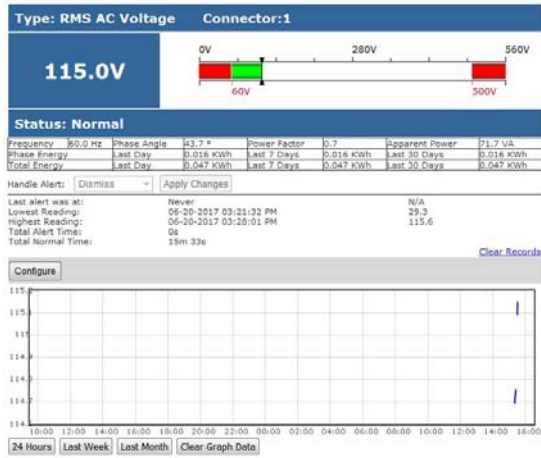

Sensor #1.2a Status

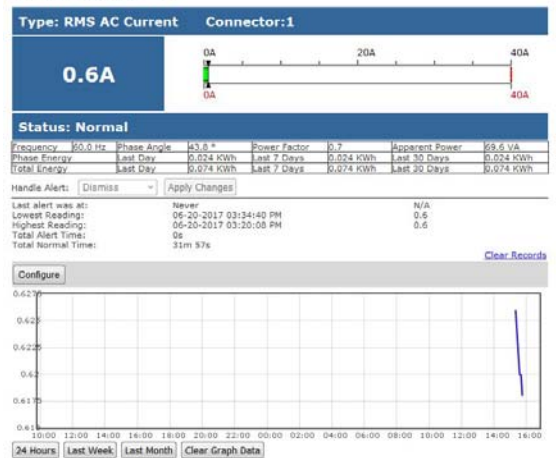

Sensor #1.3a Status



Sensor #1.4a Status

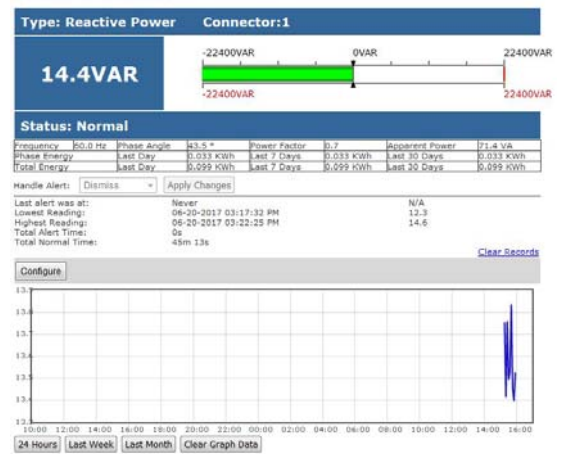

Click on the "Configure" button on any Status Page to display the Configuration page for any sensor.

Note: If the displayed "Active Power" and "Reactive Power" values for a phase are the inverse of what you expect to see (negative instead of positive, or, positive instead of negative), you can either A) disconnect, rotate 180° and reinstall the current transformer with the wire passing through in the opposite direction, or B) disconnect the two wires for that current transformer from the "AC CURRENT TRANSFORMER" terminals and reverse them.

Lab Air Compressor Phase Angle Phase A Status

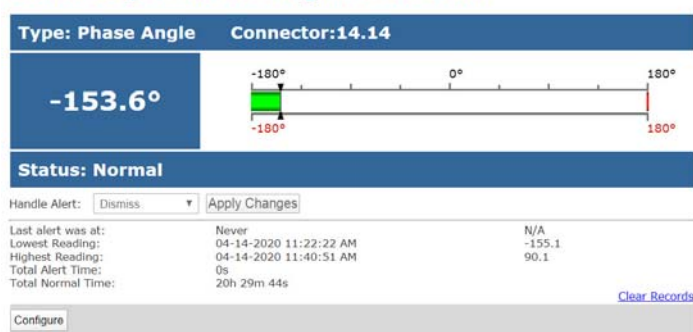

Lab Air Compressor Power Factor Phase A Status

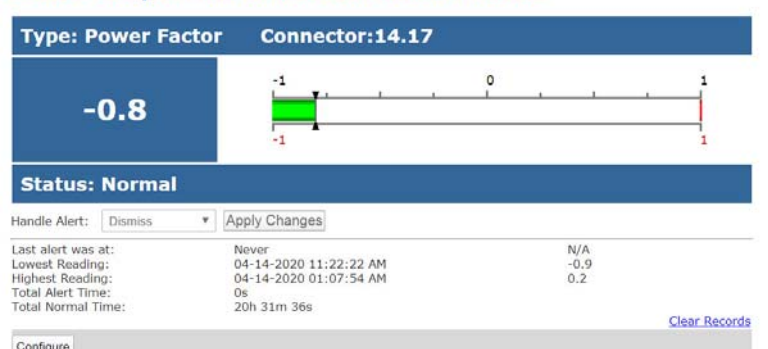

Server 1 Frequency Status

Type: Frequency Connector:12.3

60.2Hz

Status: Normal

Handle Alert: Dismiss Apply Changes

Last alert was at:	Never	N/A
Lowest Reading:	07-30-2017 02:31:31 AM	59.7
Highest Reading:	05-22-2017 09:30:58 AM	120.5
Total Alert Time:	0s	
Total Normal Time:	21h 4m 4s	

[Clear Records](#)

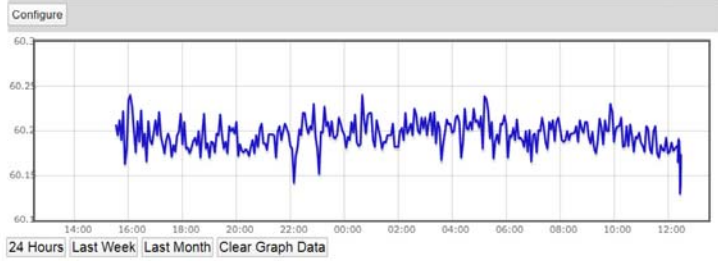

Lab Air Compressor Apparent Power Phase A Status

Type: Apparent Power Connector:14.20

5.4VA

Status: Normal

Handle Alert: Dismiss Apply Changes

Last alert was at:	Never	N/A
Lowest Reading:	04-14-2020 10:07:38 AM	5.3
Highest Reading:	04-14-2020 11:40:51 AM	12710.1
Total Alert Time:	0s	
Total Normal Time:	20h 33m 20s	

[Clear Records](#)

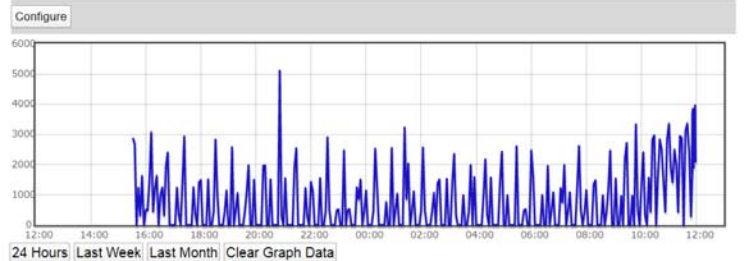

E-MNG-T1 Phase A Voltage Configuration (Type: RMS AC Voltage)

Sensor Settings

Description: E-MNG-T1 Phase A Voltage
Descriptive name for the sensor

Min. Level: 0.0
Min. supported value for the sensor

Max. Level: 480.0
Max. supported value for the sensor

3-Phase Configuration: **Wye** ←
Select the 3-Phase configuration

Min. Non-Critical Threshold: 0.0
Min. threshold below which indicates a non-critical alert condition

Max. Non-Critical Threshold: 240.0
Max. threshold above which indicates a non-critical alert condition

Min. Critical Threshold: 0.0
Min. threshold below which indicates an alert condition

Max. Critical Threshold: 265.0
Max. threshold above which indicates an alert condition

Refresh Rate: 10 Sec
The refresh rate at which the sensor view is updated

Group Settings

Schedule Settings

Non-Critical Alert Settings

Critical Alert Settings

Data Logging

Alert Simulation

Select between Wye and Delta configurations (For single or split phase use Wye)

When you set this configuration to Wye or Delta for one phase (A, B or C), it will be automatically changed for the other two phases as well.

E-MNG-T1 Phase A Current Configuration (Type: RMS AC Current)

Sensor Settings	
Description	E-MNG-T1 Phase A Current Descriptive name for the sensor
Sensor Unit	A Measurement unit
Nominal Range	10.000000 Hall-Effect transducer rated current
Min. Non-Critical Threshold	0.0 Min. threshold below which indicates a non-critical alert condition
Max. Non-Critical Threshold	10.0 Max. threshold above which indicates a non-critical alert condition
Min. Critical Threshold	0.0 Min. threshold below which indicates an alert condition
Max. Critical Threshold	10.0 Max. threshold above which indicates an alert condition
Refresh Rate	10 Sec The refresh rate at which the sensor view is updated
Group Settings	
Schedule Settings	
Non-Critical Alert Settings	
Critical Alert Settings	
Data Logging	
<input type="button" value="Save"/>	
Alert Simulation	
<input type="button" value="Simulate Alert"/> <input type="button" value="Clear Alert"/>	

Whatever value you set the current range to for one phase (A, B or C), it will be automatically changed for the other two phases as well.

If the Nominal Range is set to 0, then the Active Power and Reactive Power values will also be reported as 0.

Sensor #1.3c Configuration (Type: Active Power)

Sensor Settings	
Description	Sensor #1.3c Descriptive name for the sensor
Min. Level	0.0 Min. supported value for the sensor
Max. Level	4800.0 Max. supported value for the sensor
Min. Non-Critical Threshold	0.0 Min. threshold below which indicates a non-critical alert condition
Max. Non-Critical Threshold	4800.0 Max. threshold above which indicates a non-critical alert condition
Min. Critical Threshold	0.0 Min. threshold below which indicates an alert condition
Max. Critical Threshold	4800.0 Max. threshold above which indicates an alert condition
Refresh Rate	10 Sec The refresh rate at which the sensor view is updated
Group Settings	
Schedule Settings	
Non-Critical Alert Settings	
Critical Alert Settings	
Data Logging	
<input type="button" value="Save"/>	
Alert Simulation	
<input type="button" value="Simulate Alert"/> <input type="button" value="Clear Alert"/>	

Sensor #1.4a Configuration (Type: Reactive Power)

Sensor Settings	
Description	Sensor #1.4a Descriptive name for the sensor
Min. Level	-4800.0 Min. supported value for the sensor
Max. Level	4800.0 Max. supported value for the sensor
Min. Non-Critical Threshold	-4800.0 Min. threshold below which indicates a non-critical alert condition
Max. Non-Critical Threshold	4800.0 Max. threshold above which indicates a non-critical alert condition
Min. Critical Threshold	-4800.0 Min. threshold below which indicates an alert condition
Max. Critical Threshold	4800.0 Max. threshold above which indicates an alert condition
Refresh Rate	10 Sec The refresh rate at which the sensor view is updated
Group Settings	
Schedule Settings	
Non-Critical Alert Settings	
Critical Alert Settings	
Data Logging	
<input type="button" value="Save"/>	
Alert Simulation	
<input type="button" value="Simulate Alert"/> <input type="button" value="Clear Alert"/>	

Server 1 Frequency Configuration (Type: Frequency)

Sensor Settings	
Description	Server 1 Frequency <small>Descriptive name for the sensor</small>
Min. Level	10.0 <small>Min. supported value for the sensor</small>
Max. Level	100.0 <small>Max. supported value for the sensor</small>
Min. Non-Critical Threshold	57.0 <small>Min. threshold below which indicates a non-critical alert condition</small>
Max. Non-Critical Threshold	63.0 <small>Max. threshold above which indicates a non-critical alert condition</small>
Min. Critical Threshold	55.0 <small>Min. threshold below which indicates an alert condition</small>
Max. Critical Threshold	65.0 <small>Max. threshold above which indicates an alert condition</small>
Enable Disconnection Alert	<input type="checkbox"/> Enable alert if not connected
Refresh Rate	1 <small>Sec</small> <input type="button" value="v"/> <small>The refresh rate at which the sensor view is updated</small>
Enable Graph	<input checked="" type="checkbox"/> Enable graph for this sensor
Group Settings	
Schedule Settings	
Non-Critical Alert Settings	
Critical Alert Settings	
Data Logging	
<input type="button" value="Save"/>	
Alert Simulation	
<input type="button" value="Simulate Alert"/> <input type="button" value="Clear Alert"/>	

Lab Air Compressor Apparent Power Phase A Configuration (Type: Apparent Power)

Sensor Settings	
Description	Lab Air Compressor Apparent Power <small>Descriptive name for the sensor</small>
Min. Level	0.0 <small>Min. supported value for the sensor</small>
Max. Level	5000.0 <small>Max. supported value for the sensor</small>
Min. Non-Critical Threshold	0.0 <small>Min. threshold below which indicates a non-critical alert condition</small>
Max. Non-Critical Threshold	5000.0 <small>Max. threshold above which indicates a non-critical alert condition</small>
Min. Critical Threshold	0.0 <small>Min. threshold below which indicates an alert condition</small>
Max. Critical Threshold	5000.0 <small>Max. threshold above which indicates an alert condition</small>
Enable Disconnection Alert	<input type="checkbox"/> Enable alert if not connected
Refresh Rate	10 <small>Sec</small> <input type="button" value="v"/> <small>The refresh rate at which the sensor view is updated</small>
Enable Graph	<input checked="" type="checkbox"/> Enable graph for this sensor
Group Settings	
Schedule Settings	
Non-Critical Alert Settings	
Critical Alert Settings	
Data Logging	
<input type="button" value="Save"/>	
Alert Simulation	
<input type="button" value="Simulate Alert"/> <input type="button" value="Clear Alert"/>	

Lab Air Compressor Phase Angle Phase A Configuration (Type: Phase Angle)

Sensor Settings	
Description	Lab Air Compressor Phase Angle <small>Descriptive name for the sensor</small>
Min. Level	-180.0 <small>Min. supported value for the sensor</small>
Max. Level	180.0 <small>Max. supported value for the sensor</small>
Min. Non-Critical Threshold	-180.0 <small>Min. threshold below which indicates a non-critical alert condition</small>
Max. Non-Critical Threshold	180.0 <small>Max. threshold above which indicates a non-critical alert condition</small>
Min. Critical Threshold	-180.0 <small>Min. threshold below which indicates an alert condition</small>
Max. Critical Threshold	180.0 <small>Max. threshold above which indicates an alert condition</small>
Enable Disconnection Alert	<input type="checkbox"/> Enable alert if not connected
Refresh Rate	10 <small>Sec</small> <input type="button" value="v"/> <small>The refresh rate at which the sensor view is updated</small>
Enable Graph	<input type="checkbox"/> Enable graph for this sensor
Group Settings	
Schedule Settings	
Non-Critical Alert Settings	
Critical Alert Settings	
Data Logging	
<input type="button" value="Save"/>	
Alert Simulation	
<input type="button" value="Simulate Alert"/> <input type="button" value="Clear Alert"/>	

Lab Air Compressor Power Factor Phase A Configuration (Type: Power Factor)

Sensor Settings	
Description	Lab Air Compressor Power Factor <small>Descriptive name for the sensor</small>
Min. Level	-1.0 <small>Min. supported value for the sensor</small>
Max. Level	1.0 <small>Max. supported value for the sensor</small>
Min. Non-Critical Threshold	-1.0 <small>Min. threshold below which indicates a non-critical alert condition</small>
Max. Non-Critical Threshold	1.0 <small>Max. threshold above which indicates a non-critical alert condition</small>
Min. Critical Threshold	-1.0 <small>Min. threshold below which indicates an alert condition</small>
Max. Critical Threshold	1.0 <small>Max. threshold above which indicates an alert condition</small>
Enable Disconnection Alert	<input type="checkbox"/> Enable alert if not connected
Refresh Rate	10 <small>Sec</small> <input type="button" value="v"/> <small>The refresh rate at which the sensor view is updated</small>
Enable Graph	<input type="checkbox"/> Enable graph for this sensor
Group Settings	
Schedule Settings	
Non-Critical Alert Settings	
Critical Alert Settings	
Data Logging	
<input type="button" value="Save"/>	
Alert Simulation	
<input type="button" value="Simulate Alert"/> <input type="button" value="Clear Alert"/>	

The sensor settings are the same as any other sensor configuration (page 39 of the E-xD manual). Refer to the SYSTEM manual for details and descriptions of all the configuration criteria.

SNMP INFORMATION

When looking for the sensor information in a MIB file using SNMP, it can be found under the following locations:

- External Sensors,
- Aux Sensors,
- Aux2 Sensors
- All External Sensors

There are 22 different sensors that report from the E-ACLM-3P480 and some will be found in each of the first three locations and all can be found under "All External Sensors".

TECHNICAL SPECIFICATIONS

Description	Specification
Polling rate	1Sa/s
AC Voltage Range	0-552VAC , 2000VDC Isolated
AC Resolution	0.1VAC
Accuracy	+ 3VAC
Current Measurement	Requires Current Transformer (sold separately)
Power	5VDC from E-xD Sensor port
Current Transformer Input	.1AAC resolution
Current Range	Limited by current transformer used
Current Draw	62mA
CATx cable range:	300 Ft (91m)
Operating Temperature	32 to 158°F (0 to 70°C)
Size (In.) W x D x H	6.83 x 3.0 x 1.75
Regulatory Approvals	CE, RoHS

COPYRIGHT

Copyright © 2009-2022 Network Technologies Inc All rights reserved. No part of this publication may be reproduced, stored in a retrieval system, or transmitted in any form or by any means, electronic, mechanical, photocopying, recording, or otherwise, without the prior written consent of Network Technologies Inc, 1275 Danner Drive , Aurora, OH 44202.

CHANGES

The material in this guide is for information only and is subject to change without notice. Network Technologies Inc reserves the right to make changes in the product design without reservation and without notification to its users.

WARRANTY INFORMATION

The warranty period on this product (parts and labor) is two (2) years from date of purchase. Please contact Network Technologies Inc at (800) 742-8324 or 330-562-7070 for information regarding repairs and/or returns. A return authorization number is required for all repairs/returns.

MAN270 Revised 4/15/2022