

ENVIROMUX® Series

IPDU-Sx

Secure Remote Power Reboot Switch Installation and Operation Manual



Front and Rear View of IPDU-S2



Front and Rear View of IPDU-S8-P15

TRADEMARK

ENVIROMUX is a registered trademark of Network Technologies Inc in the U.S. and other countries.

COPYRIGHT

Copyright © 2009, 2020 by Network Technologies Inc. All rights reserved. No part of this publication may be reproduced, stored in a retrieval system, or transmitted, in any form or by any means, electronic, mechanical, photocopying, recording, or otherwise, without the prior written consent of Network Technologies Inc, 1275 Danner Drive, Aurora, Ohio 44202.

CHANGES

The material in this guide is for information only and is subject to change without notice. Network Technologies Inc reserves the right to make changes in the product design without reservation and without notification to its users.

FIRMWARE VERSION

IPDU-S2 Version 1.5

IPDU-S4/8 Version 1.6

This product contains software licensed under the GNU Public License version 2 and other open source licenses.

(<http://www.gnu.org/copyleft/gpl.html>)

You may obtain the complete open-source code free of charge from Network Technologies Inc (send email to tech-consult@ntigo.com) for more information.

TABLE OF CONTENTS

IPDU-Sx.....	1
Secure Remote Power Reboot Switch	1
Installation and Operation Manual	1
Introduction.....	1
Materials.....	2
Supported Web Browsers	2
Features and Functions.....	3
Installation	5
Connect AC Power Cables	5
Ethernet Connection	5
Terminal Connection for RS232	6
Sensor Attachment	6
Front Panel LEDs Indicate Status	7
Cascaded Installation via RS485 Connection	8
GSM Modem Connection	8
Rack Mounting Instructions	9
Overview.....	10
Administration	10
General Functions.....	10
Security	12
Device Discovery Tool.....	13
How to Use the Device Discovery Tool	13
Operation via Web Interface.....	14
Log In and Enter Password	14
Monitoring	15
Configure a Power Outlet	17
Line Monitor	20
Monitor and Configure Sensors	22
Monitor IP Devices.....	25
Monitor Events	28
Administration	30
System Configuration	30
Enterprise Configuration	32
Network Configuration	33
Cascade Configuration	38
User Configuration.....	43
Security	47
System Information.....	50
Update Firmware	51
Reboot the System	52
Log.....	53
View Event Log.....	53
View Data Log.....	54

Log Settings.....	54
Support	57
Logout.....	57
Operation via Text Menu- IPDU-Sx.....	58
Connection Via Console Port	58
Connect to IPDU-Sx from Command Line.....	59
Connect Via Telnet	59
Connect Via SSH.....	59
Using the Text Menu.....	61
Monitoring	61
System Configuration	77
Enterprise Configuration	79
Network Configuration	79
Cascade Configuration	85
User Configuration.....	90
Security Configuration	94
Event and Data Logs	97
System Information.....	100
Reboot	101
Text Menu for Non-Administrative Users.....	102
Monitoring.....	102
User Accessible Settings	104
Reset Button.....	107
Circuit Breaker.....	107
USB Port.....	107
Wiring Methods	108
PC-to IPDU-Sx Crossover Cable.....	108
RS485 Sensor Cable	108
Technical Specifications.....	109
Troubleshooting.....	110
How to Create an x.509 Certificate for ENVIROMUX	111
Index.....	119
Warranty Information	120

TABLE OF FIGURES

Figure 1- Connect power cords.....	5
Figure 2- Connect IPDU-S2 to the Ethernet.....	5
Figure 3- Connect IPDU-S2 to local terminal	6
Figure 4- Connect sensors for environmental monitoring	6
Figure 5- LEDs on front of IPDU-S2	7
Figure 6- LEDs on front of IPDU-S4/S8	7
Figure 7- Cascade installation- RS485 Connection	8
Figure 8- Connect a GSM modem	8
Figure 9- Secure rack mount ears to IPDU-Sx.....	9
Figure 10- Secure IPDU-Sx to rack	9
Figure 11- Device Discovery Tool.....	13

Figure 12- Login prompt to access web interface	14
Figure 13- Summary page	15
Figure 14- Summary page and the Monitoring menu.....	16
Figure 15- Status page for a power outlet.....	16
Figure 16- Power Outlet Configuration page.....	17
Figure 17- More settings for Power Outlet Configuration	18
Figure 18- Line Monitor Categories	20
Figure 19- Configuration Categories.....	21
Figure 20- Sensor Status page	22
Figure 21- Sensor Configuration page	22
Figure 22- Sensor Configuration- full view of settings.....	23
Figure 23- IP Devices listing-none monitored yet	25
Figure 24- Add New IP Device page.....	25
Figure 25- IP Device Configuration page.....	26
Figure 26- Power Outlet Association for IP Device	27
Figure 27- IP Device list with new devices added.....	27
Figure 28- IP Device Status page	27
Figure 29- Event Monitoring.....	28
Figure 30- Add New Event.....	28
Figure 31- Configure New Event.....	28
Figure 32- List of Configured Event	29
Figure 33- Adjust settings for events	29
Figure 34- System Configuration page	30
Figure 35- Enterprise Configuration	32
Figure 36- Network Configuration page	33
Figure 37- Network Configuration- more settings	34
Figure 38- IP Aliases.....	36
Figure 39- Setup SNMP to control output relays.....	37
Figure 40- Cascading- Set the configuration type.....	38
Figure 41- Configure as RS485 Slave	39
Figure 42- Configure as Ethernet Slave.....	39
Figure 43- Configure as RS485 Master	40
Figure 44- Configure as Ethernet Master.....	41
Figure 45- Cascade Notification Settings.....	42
Figure 46- Users page	43
Figure 47- Configure Users page.....	43
Figure 48- Configure User- more options.....	44
Figure 49- Summary page for User without Admin privileges	46
Figure 50- Security Configuration page	47
Figure 51- Security Configuration-X509 Certificate and Login Alerts.....	48
Figure 52- Security Configuration- IP Filtering Rules	49
Figure 53- System Information page.....	50
Figure 54- Update Firmware page	51
Figure 55- Reboot System page	52
Figure 56- System is rebooting	52
Figure 57- Event Log page	53
Figure 58- Data Log page	54
Figure 59- Log Settings page.....	55
Figure 60- Log to USB Flash Settings.....	55
Figure 61- Enable USB Port	56
Figure 62- Support.....	57

Figure 63- Logout	57
Figure 64- Text Menu Login screen	58
Figure 65- Text Menu- Administrator Main Menu.....	59
Figure 66- Text Menu- Main Administrator Menu in IPDU-S4/-S8	60
Figure 67- Text Menu- User Main Menu	60
Figure 68- Text Menu-Monitoring Menu.....	61
Figure 69- Text Menu-Power Outlet Status.....	62
Figure 70- Text Menu-Sensor Status	62
Figure 71- Text Menu- Line Monitor Parameters	63
Figure 72- Text Menu-View IP Devices.....	63
Figure 73- Text Menu-Configure Power Outlets	64
Figure 74- Text Menu-Power Outlet menu.....	64
Figure 75- Text Menu-Power Outlet Settings.....	65
Figure 76- Text Menu-Power Outlet Notification Settings	65
Figure 77- Text Menu-Power Outlet Operation Settings	66
Figure 78- Text Menu-Configure Sensors list	67
Figure 79- Text Menu-Configuration Menu for Sensor.....	68
Figure 80- Text Menu-Sensor Settings	68
Figure 81- Text Menu-Sensor Alert Settings.....	69
Figure 82- Text Menu-Sensor Data Logging.....	71
Figure 83- Text Menu- Sensor Power Outlet Association	71
Figure 84- Configure Line Monitor Parameters.....	72
Figure 85- Configuration Menus	72
Figure 86- Text Menu-Configure IP Devices List	73
Figure 87- Text menu-Configuration Menu for IP Devices	73
Figure 88-Text Menu-IP Device Settings	74
Figure 89- Text Menu-IP Device Alert Settings.....	75
Figure 90- Text Menu-IP Device Data Logging.....	76
Figure 91- Text Menu-IP Device Power Outlet Association	76
Figure 92- Text Menu- System Configuration	77
Figure 93- Text Menu-Time Settings menu.....	77
Figure 94- Text Menu-Restore Default Settings.....	78
Figure 95- Text Menu-Enterprise Configuration.....	79
Figure 96- Text Menu-Network Configuration	79
Figure 97- Text Menu-IP Settings Menu	80
Figure 98- Text Menu-SMTP Server Settings	81
Figure 99- Text Menu-SNMP Server Settings.....	82
Figure 100- Text Menu-Misc. Service Settings menu	83
Figure 101- Text Menu- IP Alias Settings	84
Figure 102- Text Menu- Type Setting for Cascading	85
Figure 103- Text Menu- Unit RS485 Address	86
Figure 104- Text Menu- Type is Ethernet Slave	86
Figure 105- Text Menu- RS485 Master's slave list	87
Figure 106- Text Menu- Edit RS485 Slave Address	87
Figure 107- Text Menu- Ethernet Master's slave list.....	88
Figure 108-Text Menu- Edit Ethernet Slave Address.....	88
Figure 109- Text Menu-Cascade Notification Settings.....	89
Figure 110- Cascade Notification Configuration	89
Figure 111- Text Menu-User Configuration.....	90
Figure 112- Text Menu-Confirm to add new user	90
Figure 113- Text Menu-Configuration List for User	91

Figure 114- Text Menu-User Account Settings	91
Figure 115- Text Menu-User Contact Settings.....	92
Figure 116- Text Menu-User Activity Schedule.....	93
Figure 117- Text Menu-Security Configuration	94
Figure 118- Text Menu-Authentication Settings.....	94
Figure 119- Text Menu-IP Filtering	95
Figure 120- Text Menu-Configure IP Filter rule.....	96
Figure 121- Text Menu-Event & Data Logs.....	97
Figure 122- Text Menu-View Event Log.....	97
Figure 123- Text Menu-View Data Log	98
Figure 124- Text Menu-Event Log Settings	99
Figure 125-Text Menu-Data Log Settings	99
Figure 126- Enable Log to USB	100
Figure 127-Text Menu-System Information.....	100
Figure 128- Text Menu-Reboot the IPDU-S2.....	101
Figure 129- Text Menu-User Main Menu	102
Figure 130-Text Menu-User Monitoring Menu	102
Figure 131- Text Menu-User accessible status menus	103
Figure 132- Text Menu-User Accessible Settings.....	104
Figure 133- Text Menu-User Account Settings	104
Figure 134- Text Menu-User Contact Settings.....	105
Figure 135- Text Menu-User Activity Schedule.....	106
Figure 136- Location of Reset button.....	107
Figure 137- Circuit Breaker Protection.....	107
Figure 138- USB Flash Drive port	107

INTRODUCTION

The ENVIROMUX® IPDU-Sx Secure Remote Power Reboot Switch allows you to remotely reboot and control power (ON/OFF) or to schedule periodic power cycles to servers or other powered devices from any location via secure web interface, RS232, SSH, or Telnet.

Models Include:

Model	Description	Model	Description
IPDU-S2	2-Outlet	IPDU-S8-P10	8-Outlet, for Euro/UK
IPDU-S4-P10	4-Outlet, for Euro/UK	IPDU-S8-P15	8-Outlet, for US/Canada
IPDU-S4-P15	4-Outlet, for US/Canada		

-P10 models include IEC 320-C13 outlets

-P15 models include NEMA 5-15R outlets

Optional: For industrial version with extended temperature range (-40°F to 158°F (-40°C to 70°C))- add "OT3" to the model number (IPDU-S8-P15-**OT3**)

Features:

- Supports Power ON or OFF in addition to Reboot.
- Three operating modes for power control:
 - Manual — user can power cycle an outlet for a configured time sequence or power an outlet ON or OFF.
 - Periodic — set a date, time, and duration of the power cycle. Power cycles can also be scheduled as recurring daily, weekly, or monthly.
 - Associated — power ON or OFF a device when a sensor exceeds a user-defined threshold, or power cycle if an IP device is unresponsive.
- Security: HTTPS, SSHv2, SSLv3, IP Filtering, LDAPv3, AES 256-bit encryption, 16-character username/password authentication, user account restricted access rights.
- Power Up Sequencing limits in-rush current.
- Monitor (ping) up to 8 IP network devices.
 - Configure the timeout and number of retries to classify a device as unresponsive.
 - Power cycle associated power outlets if devices are not responding.
 - Alerts are sent if devices are not responding.
- Outlets can be individually named (up to 80 characters).
- Monitor environmental conditions.
 - Supports two sensors, including: temperature, humidity, and water detection.
 - When a sensor goes out of range of a configurable threshold, the system will notify you via email, syslog, LEDs, web page, and network management (SNMP).
 - Powers up or down devices when sensors go out of range of user-defined thresholds.
- Operates on a hardened Linux system.
- Firmware upgradeable "in-field" through console port or Ethernet.
- Up to 17 units can be cascaded into a system of up to 136 outlets controlled either locally via RS485 or remotely via web interface (models IPDU-S4 and IPDU-S8 only)
- Line Monitoring (IPDU-S4 and IPDU-S8 only)
 - Monitor outlet voltage
 - Monitor outlet current
 - Monitor outlet frequency
 - Monitor circuit breaker status
- Configurable events (IPDU can send alerts or control outlets as reaction to specific sensor readings) (models IPDU-S4 and IPDU-S8 only)

MATERIALS

Materials supplied with this kit:

- NTI IPDU-Sx Secure Remote Power Reboot Switch
- 1- IEC320-C13 Line cord, country specific (PS4162) (IPDU-S2 and IPDU-S4/8-P10 only)
- 1- IEC320-C14 Output cord (PS4163) (IPDU-S2 and IPDU-S4/S8-P10 only)
- 1- DB9 Female-to-RJ45 Female adapter (CT6182)
- 1- 5 foot RJ45-to-RJ45 CAT5 patch cable (CB4352)
- CD containing a pdf of this manual, a SNMP MIB file (2-outlet version and 4/8-outlet version), and the NTI Discovery Tool
- Rackmount Kit as detailed in the chart below:

Model	Mounting Brackets (X2)	Screws (X6)	Cage Nuts (x4)	#10-32 Screws (x4)
IPDU-S2	MP4040	HW5133	HW5118	HW5124
IPDU-S4-Pxx	MP4212	HW5133	HW5118	HW5124
IPDU-S8-Pxx	MP4210	HW5133	HW5118	HW5124

SUPPORTED WEB BROWSERS

Most modern web browsers should be supported. The following browsers have been tested:

- Microsoft Internet Explorer 6.0 or higher
- Netscape 7.2 or higher
- Mozilla FireFox 1.5 or higher
- Opera 9.0
- Google Chrome
- Safari 4.0 or higher for MAC and PC

FEATURES AND FUNCTIONS

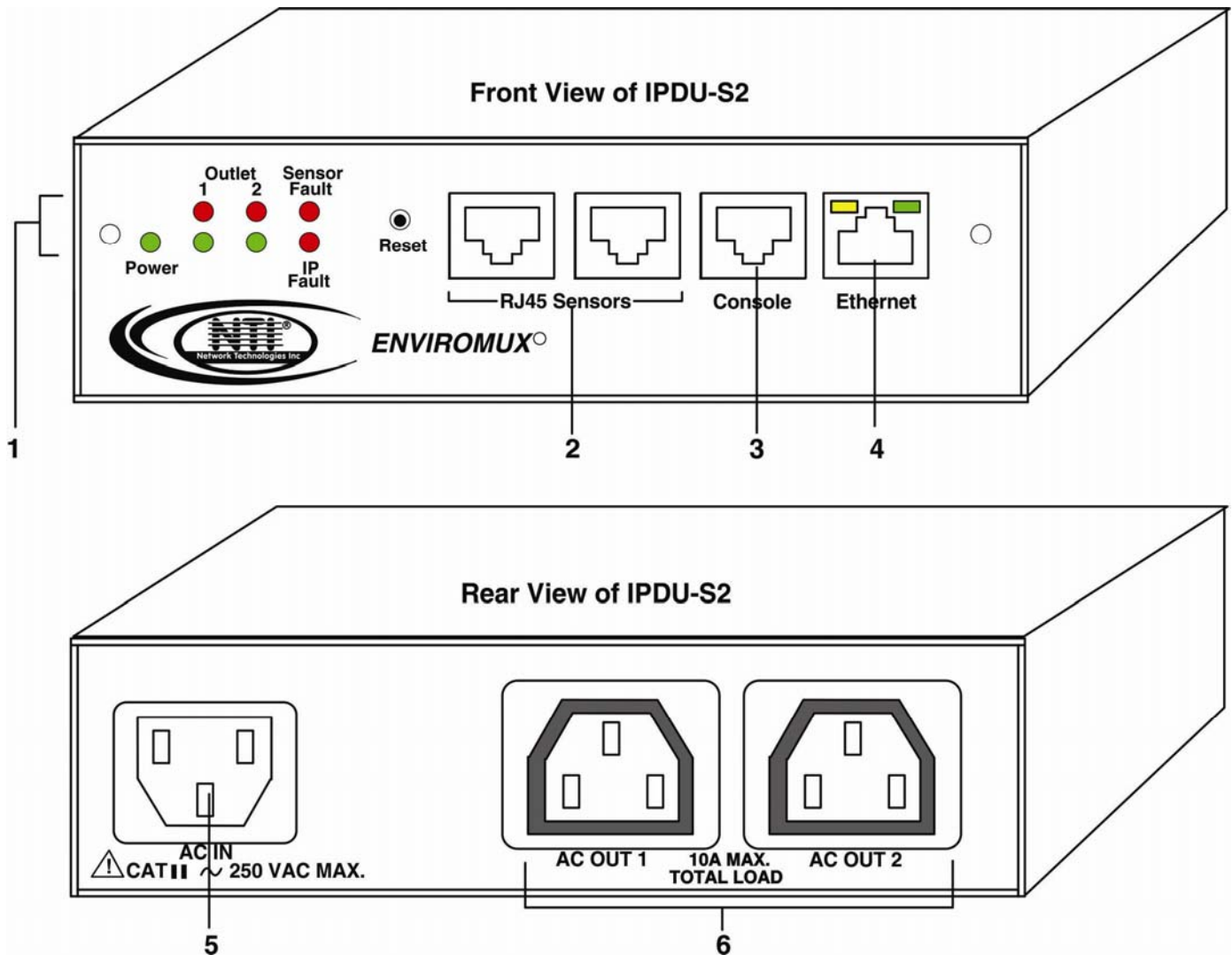

IPDU-S2

1. LED Indicators

- "POWER" (green) — indicates device is powered
- "OUTLET" (green / red) — outlet is ON (green) or OFF (red)
- "SENSOR FAULT" (red) — illuminates if a sensor goes out of range of a configurable threshold
- "IP FAULT" (red) — illuminates if an IP device is unresponsive

2. **RJ45 Sensors**- RJ45 female- for attachment of temperature, humidity, or liquid detection sensors

3. **Console**- RJ45 female- for connection to a terminal for local control

4. **Ethernet**- RJ45 female with LED indicators- for connection to an Ethernet for remote multi-user control and monitoring
 Yellow LED- indicates 100Base-T activity when illuminated, 10Base-T activity when dark
 Green LED – illuminated when Ethernet link is present, strobing indicates activity on the Ethernet port

5. **AC IN**- IEC320-C14 socket- for connection of AC line cord

6. **AC OUT 1 & 2**- IEC320-C13 socket- for connection of load device cables

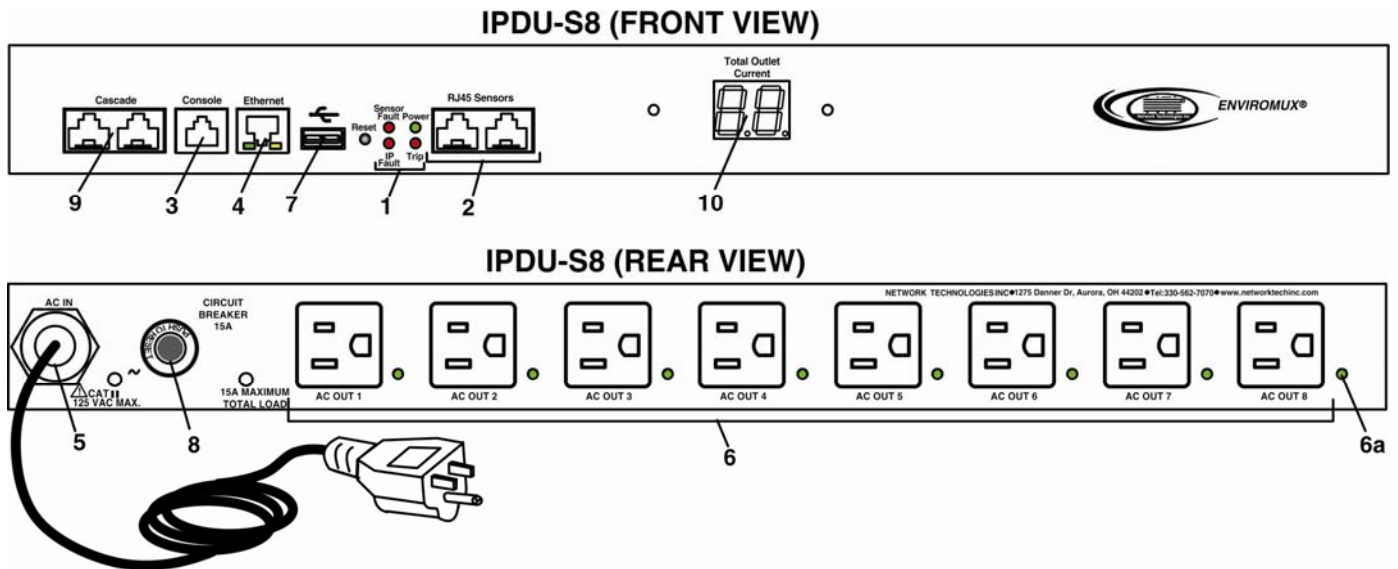

IPDU-S4 / IPDU-S8

1. LED Indicators

- "POWER" (green) — indicates device is powered
- "SENSOR FAULT" (red) — illuminates if a sensor goes out of range of a configurable threshold
- "IP FAULT" (red) — illuminates if an IP device is unresponsive
- "TRIP" (red) -illuminates if the circuit breaker on the rear of the unit trips OFF

2. **RJ45 Sensors-** RJ45 female- for attachment of temperature, humidity, or liquid detection sensors

3. **Console-** RJ45 female- for connection to a terminal for local control

4. **Ethernet-** RJ45 female with LED indicators- for connection to an Ethernet for remote multi-user control and monitoring
 Yellow LED- indicates 100Base-T activity when illuminated, 10Base-T activity when dark
 Green LED – illuminated when Ethernet link is present, strobing indicates activity on the Ethernet port

5. **AC IN-** 120V AC line cord (15A maximum load (-P15 models only)
 The IPDU-S4/S8-P10 has a IEC320-C14 socket (item 5 on the IPDU-S2)

6. **AC OUT 1-8-** NEMA 5-15R outlets (-P15 models) or IEC 320-C13 outlets (-P10 models) - for connection of load device cables
 6a. **Green LED** - illuminates when associated outlet power is ON (1 per outlet)

7. **USB-** USB Type A port- for connection of a GSM modem for SMS communication and/or flash drive (USB 2.0 Full Speed supported) for logging data

8. **Circuit Breaker-** 15A Circuit breaker for protection of the devices powered by the IPDU-Sx

9. **Cascade-** RJ45 Female- for cascading multiple IPDU-S4 and IPDU-S8 units

10. **LED Display-** for displaying the total AC current being supplied by the AC outlets on the IPDU-Sx

INSTALLATION

Connect AC Power Cables

The IPDU-Sx may be connected to a 100-240VAC power supply. A 120V power cord with NEMA 5-15 connector is provided for connection to a power supply. The AC outlets (“AC OUT 1” and “AC OUT 2”) are rated for up to 10A @ 120/240VAC and the combined maximum load cannot exceed 10A for IPDU-S2, IPDU-S4/S8-P10, or 15A for IPDU-S4/S8-P15.

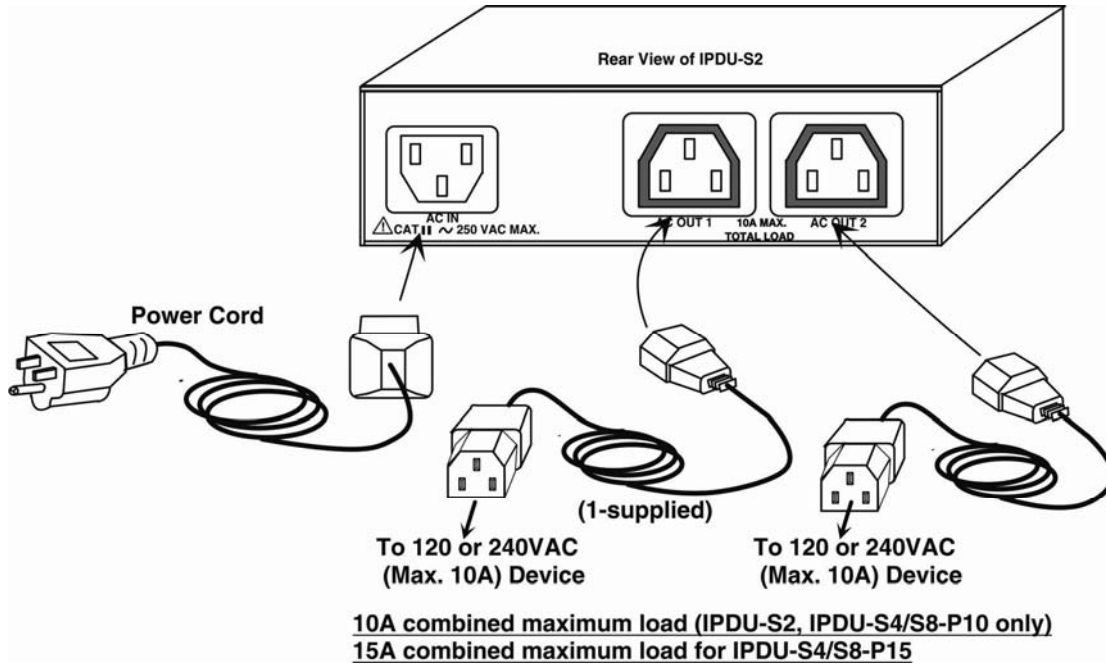

Figure 1- Connect power cords

Note: In the event of an internal power supply failure, the AC IN and AC OUTLETS on the IPDU-S2, IPDU-S4-Pxx and IPDU-S8-Pxx will fail open. No power will pass through.

Ethernet Connection

Connect a CAT5 patch cable (RJ45 connectors on each end wired pin 1 to pin 1, pin 2 to pin 2 etc) from the local Ethernet network connection to the connector on the IPDU-Sx marked "ETHERNET".

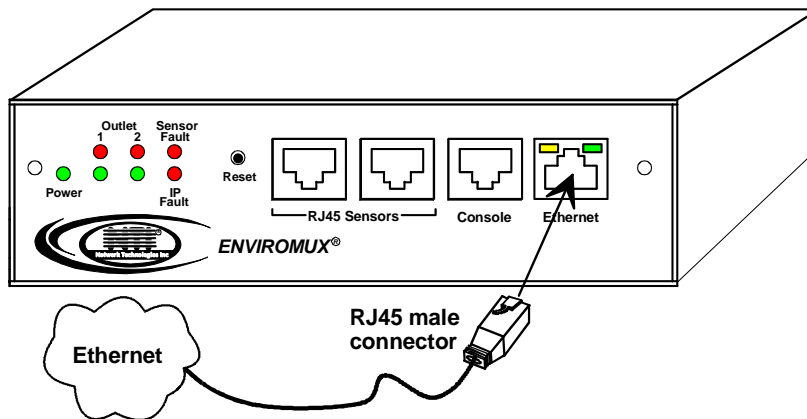

Figure 2- Connect IPDU-S2 to the Ethernet

Note: A direct Ethernet connection can be made with a PC using a crossover cable. For the pinout of this cable, see page 108.

Terminal Connection for RS232

To make a direct serial connection to the IPDU-Sx from a terminal with HyperTerminal via RS232, an RJ45 female DCE port labeled "Console" is provided. Connect a CAT5 patch cable (supplied) between the port labeled "Console" and a PC with a terminal program (e.g. HyperTerminal). An adapter (supplied) may need to be used to connect the patch cable to the PC.

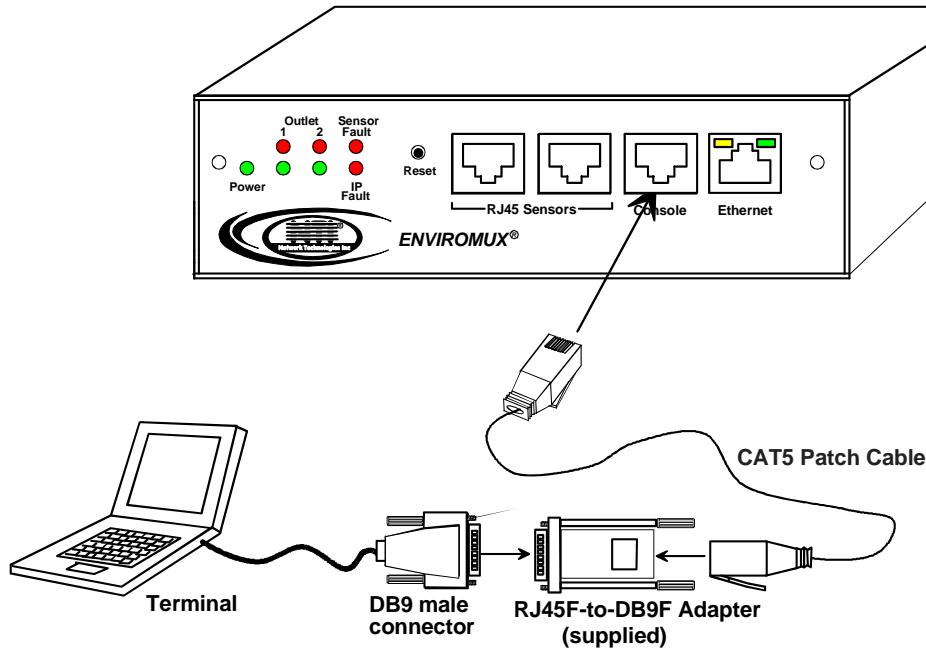

Figure 3- Connect IPDU-S2 to local terminal

Sensor Attachment

The IPDU-Sx is capable of sensing and reporting readings taken from ENVIROMUX temperature (ENVIROMUX-STs), humidity (ENVIROMUX-SHS), temperature/humidity (ENVIROMUX-STHS), wide range temperature/humidity (ENVIROMUX-STHS-99) and liquid detection (ENVIROMUX-LDTx-y) sensors. Any of these can be connected to the "RJ45 Sensors" ports and used to determine if connected devices should be powered ON or OFF based on readings taken. The maximum CAT5 cable length for attachment of sensors is 1000 feet. For the cable pinout, see page 108.

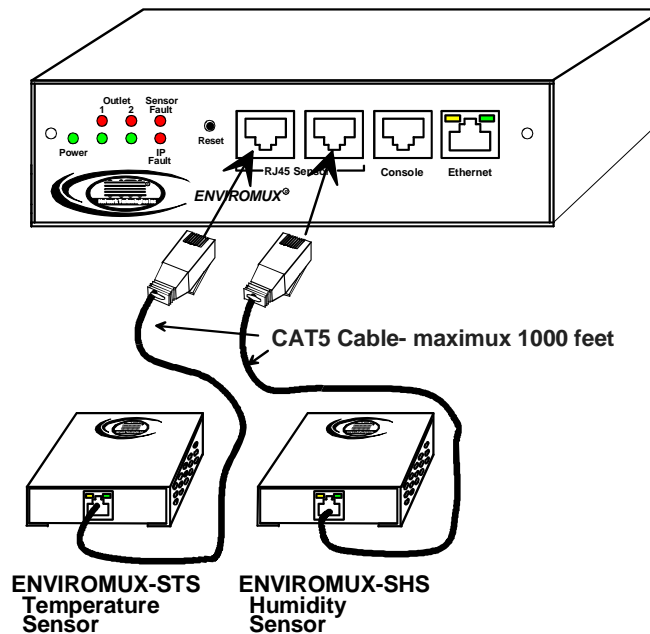

Figure 4- Connect sensors for environmental monitoring

Front Panel LEDs Indicate Status

With proper connections made, the IPDU-Sx is now ready to use. With the power cord attached and plugged into an AC outlet, the “Power” , “Outlet 1” and “Outlet 2” green LEDs should be illuminated on the front of the IPDU-S2. The table below describes the function of each LED.

The IPDU-S4 and IPDU-S8 have a green LED adjacent to each outlet that will illuminate when power is ON to the outlet. (See page 4.)

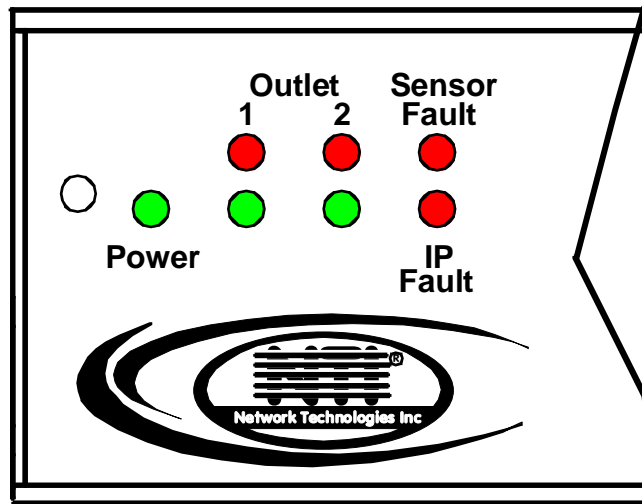

Figure 5- LEDs on front of IPDU-S2

LED	Description
Power-green	Indicates the power status of the IPDU-Sx
Outlet 1 and 2-red	Illuminates when the AC OUT (1 or 2) is powered OFF
Outlet 1 and 2-green	Illuminates when the AC OUT (1 or 2) is powered ON
Sensor Fault-red	Illuminates if the connected sensors are outside of their thresholds
IP Fault- red	Illuminates if there is an IP monitoring fault
Trip - red	Illuminates if the breaker on the IPDU-S4/8 trips
Total Outlet Current	Displays total current draw of all outlets (IPDU-S4/ -S8 only)

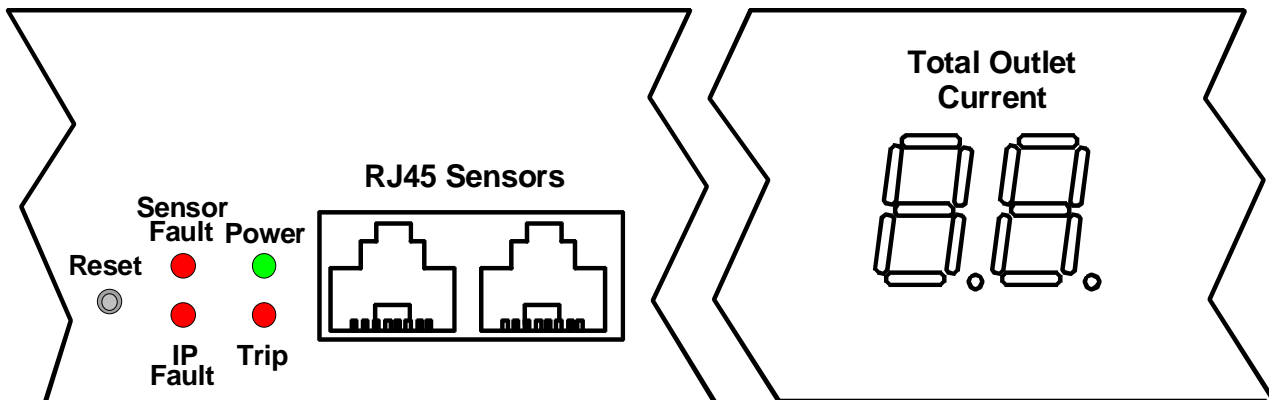

Figure 6- LEDs on front of IPDU-S4/S8

Cascaded Installation via RS485 Connection

Two RJ45 ports are provided on the front of models IPDU-S4 and IPDU-S8. These are used when multiple units are connected together (cascaded) and controlled as one system using the RS485 Connect method (see page 8). Cascading enables the monitoring of all sensors and outlets from up to 17 IPDU-S4 or IPDU-S8 (or any combination of each model). For an RS485 Connect installation, connect a CAT5/5e/6 patch cable with RJ45 male connectors on each end (wired straight thru, pin 1 to pin 1, pin 2 to pin 2, etc.) between the "Cascade" ports as shown in the image below. The maximum distance from the Master to the last Slave can be no more than 1000 feet. With this properly connected and configured (pages 38 and 85), the user can monitor the sensors and outlets of all systems from either a single connected terminal (page 6) or through the Web Interface.

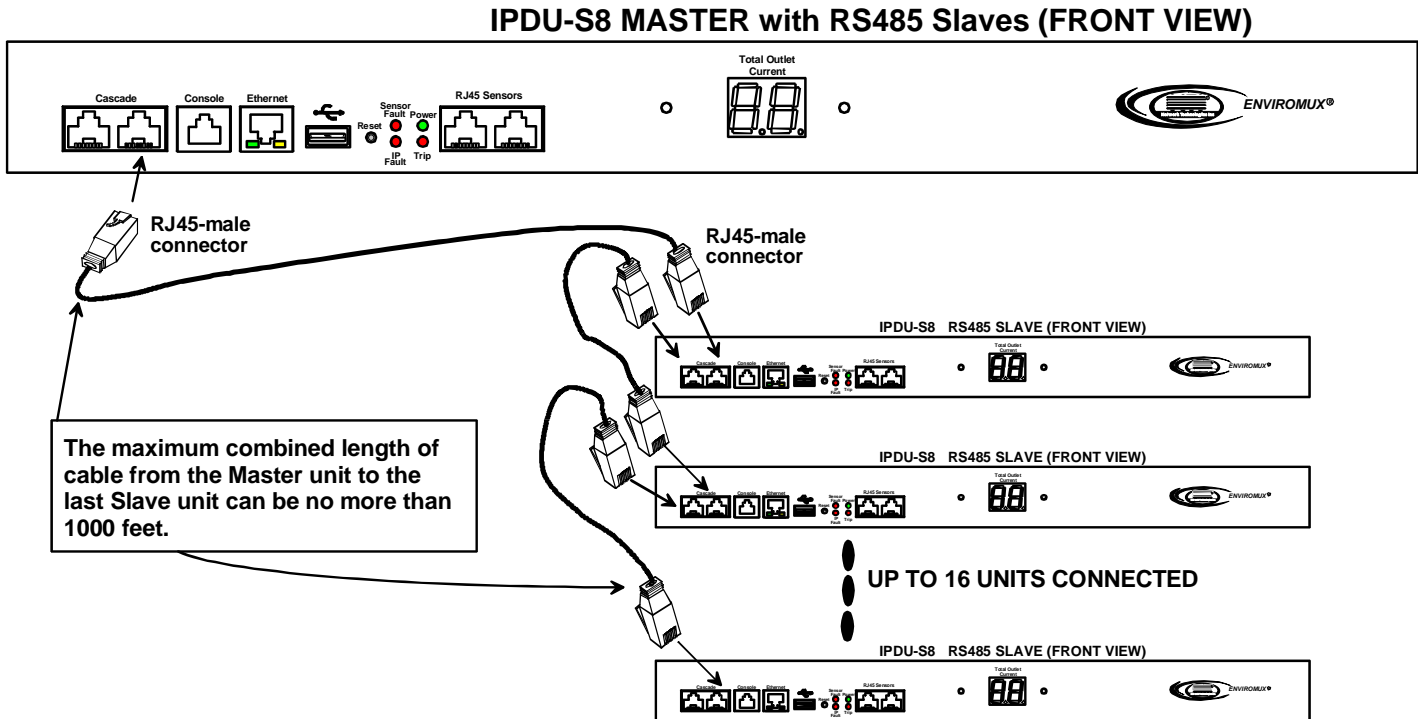

Figure 7- Cascade installation- RS485 Connection

GSM Modem Connection

(IPDU-S4 and IPDU-S8 Models only)

If alert notifications via SMS to a cell phone are desired, a GSM modem can be connected to the USB port on the IPDU-S4 / -S8 models. With a GSM modem connected, a user can receive SMS alert messages directly on their cell phone. The external GSM modem is powered by the USB port.

A GSM modem that has been tested and is confirmed to be compatible with the IPDU-S4/ -S8 is the iCON 452. To order this modem, contact NTI and ask for the ENVIROMUX-3GU.

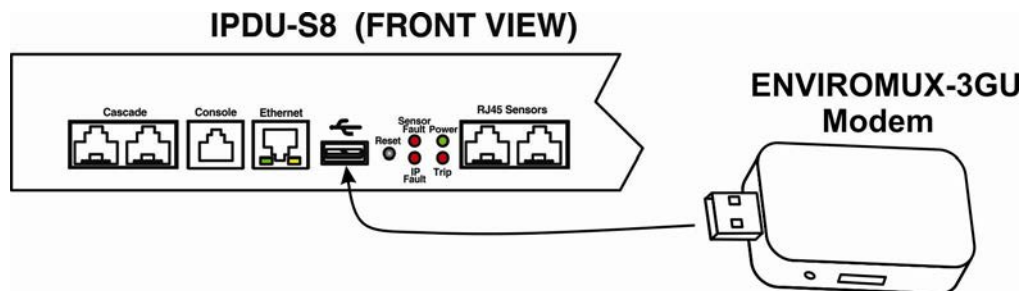

Figure 8- Connect a GSM modem

Note: The modem connected to the IPDU-Sx will send SMS messages only. No access to the IPDU-Sx is possible through the modem.

Rack Mounting Instructions

The IPDU-S4R and IPDU-S8 were designed to be mounted in a rack. They include a rack mount kit to make attachment easy.

1. Attach the ears to the IPDU-Sx using the #6-32x3/16" flat Phillips-head screws (6) provided as shown in the illustration below.
2. The holes in the ears should line up with pre-threaded holes in the sides of the IPDU-Sx. Tighten the screws securely.

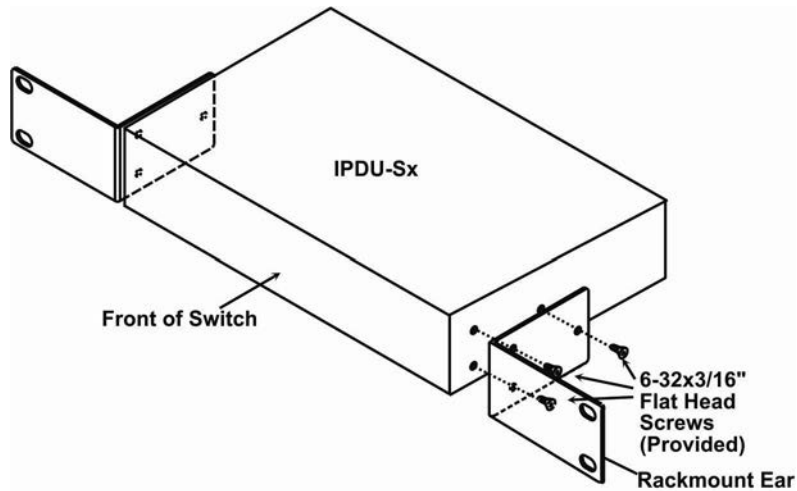

Figure 9- Secure rack mount ears to IPDU-Sx

3. Install 4 cage nuts to the rack in locations that line up with the holes in the mounting ears on the IPDU-Sx.
4. Secure the IPDU-Sx to the rack using four #10-32x3/4" screws and cage nuts (provided). Be sure to tighten all mounting screws securely.

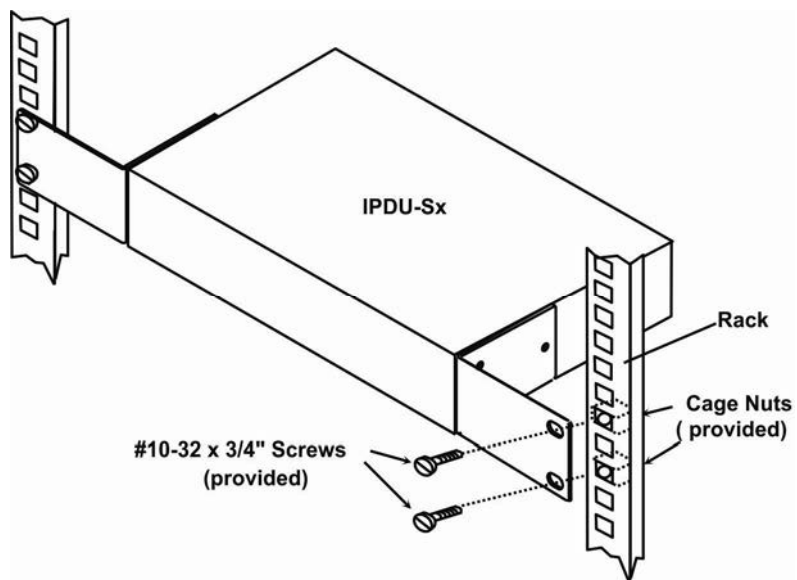

Figure 10- Secure IPDU-Sx to rack

5. Attach all cables securely to the IPDU-Sx and where necessary supply adequate means of strain relief for cables

OVERVIEW

Administration

The IPDU-Sx can be administered in any one of the following ways:

- Using a terminal program (e.g. HyperTerminal) via an RS232-Link, connected to Console Port.
- Using Telnet or SSH protocol via the Ethernet Port.
- Using the web interface (HTTP/HTTPS protocol) via the Ethernet Port.

The following administrative controls are available in the IPDU-Sx, thru the menu.

- View or modify the administrator & user parameters (passwords, outlet/sensor alert subscriptions, admin access, etc.)
- View or modify the network parameters (e.g. IP Address, Gateways, DNS, etc.)
- View and clear system event logs
- Clear, import, export and restore configuration parameters
- Firmware upgrades for the IPDU-Sx, thru Console port or over Ethernet
- View or modify sensor, IP device, and outlet configurations

Additional administrative controls available in IPDU-S4 and IPDU-S8 models include:

- Cascade configuration
- USB port enable/disable (for data logging)
- Three configurable IP aliases

General Functions

Manual Power Control

The user has the ability to power cycle either of the outlets by merely selecting the outlet and clicking on the appropriate action from the web interface or text menu.

Periodic Power Control

The user can schedule power cycles for each of the outlets by setting the date and time of the reboot, the duration of the power cycle (time ON or OFF), and whether the power cycle will be one-time, daily, weekly, or monthly. In the event that a user schedules a monthly reboot on a date which not all months have, (e.g. the 31st of a month), the scheduled reboot will execute on the final day of the months with fewer days.

Associated Power Control

The user can configure an outlet to power cycle when a sensor exceeds a certain threshold or when an IP address is non-responsive.

Sensor Alerts

A high and low threshold limit can be set for each temperature or humidity sensor. When a sensor takes a reading that is outside a threshold, an alert notification is generated. The user can specify the frequency of alert notifications to match his or her schedule. Also, there will be some hysteresis involved with alert notifications. This means if a sensor's readings are moving in and out of the threshold boundaries within a configurable period of time, additional alert notifications will not be sent. After an alert is activated, it remains persistent even if the condition of the sensors returns back to normal, until the user acknowledges or dismisses that alert. The user has the option to set the unit to auto-clear the alert if the sensor's status returns to normal, and the user can be notified if the condition goes back to normal. Alert notifications will be provided through four main methods: visible notification via one of the user interfaces (red "Fault" LED on front panel, alert on webpage, alert in text menu), emails, syslog message and/or SNMP traps.

IP Monitoring & Alerts

The individual IP addresses of the devices connected to the “AC Out” ports can be monitored. The Remote Power Controller will ping each address, and if a response is received, the IP address status is considered to be “OK”. The user will have the option to configure the IPDU-Sx to cycle power at the corresponding device’s outlet if no response is received, and an alert will be logged and sent. The user can configure the timeout for a response and the number of retries before signaling an alert and power cycling. The IPDU-Sx can also be configured to monitor the IP addresses of the network switches and routers to which these devices are connected, so as to determine if the problem is due to a lack of response from the device or a network failure. Alert notifications will be provided through four main methods: visible notification via one of the user interfaces (red “Fault” LED on front panel, alert on webpage, alert in text menu), emails, syslog messages and/or SNMP traps.

Event Log

The IPDU-Sx maintains an event log. The event log includes power-ON, system, and alert notifications, as well as user login/logout, and user alert handling. The maximum number of log entries is 1000, and these entries are sorted in chronological order. The log can be viewed at any time through the web interface or text menu, and can be saved as a text file. Log entries can be removed individually or all at once. In the IPDU-S4 / -S8, the event log can be stored as a portable text file on a removable USB flash drive.

Data Log

The IPDU-Sx maintains a data log. The data log includes readings taken from sensors, IP devices, and power outlets being monitored. The maximum number of log entries is 1000, and these entries are sorted in chronological order. The log can be viewed at any time through the web interface or text menu, and can be saved as a text file. Log entries can be removed individually or all at once. In the IPDU-S4 / -S8, the data log can be stored as a portable text file on a removable USB flash drive.

Email

The IPDU-Sx can access an SMTP server to send outgoing email. Outgoing email would contain pre-formatted alert notifications. SMTP server information can be configured using one of the interfaces. Email addresses can be configured through web pages or text menu. Each user can have their own email address.

The email messages sent by the Remote Power Controller have a fixed format. Alert emails contain 6 fields and will have a configurable title. The title is configurable for each sensor, device, IP address, or outlet. The title is the “email subject” in all configuration pages. A sample message is shown below:

```
ENTERPRISE: Enterprise name here
LOCATION: Danner Drive
CONTACT: John Smith
DESCRIPTION: Undefined #5
TYPE: Humidity
MESSAGE: Sensor value exceeded thresholds
```

SNMP

The IPDU-Sx can send alerts as SNMP traps when a sensor or IP device enters/leaves alert mode, when a power outlet changes state, and for all log events. Using SNMP network management software or a MIB browser, a user can monitor all sensor statuses and system IP settings. The destination for SNMP traps can be configured for each user.

Note: The SNMP MIB file (ipdu-s2-v1-xx.mib for 2 port model, ipdu-s8-v1-xx.mib for 4 and 8 port models), for use with SNMP network management software or SNMP trap receiver, can be found on the manual CD. Click on the link to open the file; then save the file to your hard drive to use with the SNMP MIB browser or SNMP trap receiver.

GSM Modem

An external GSM modem can be connected to allow the system to send alert notifications via SMS messages. When a power outlet changes state or a sensor crosses a threshold, an alert notification can be formatted to SMS message (see page 17) and the modem can transmit the message to the pre-specified cellular number of each user configured to receive SMS messages (page 45).

Security

User Settings

In order to configure and operate the IPDU-Sx, each user must login with a unique username and password. The Administrator can configure each user's settings as User or Administrator. An Administrator has access to all configurations and controls. A user can monitor sensors, outlets, and IP devices. A user can edit his/her own account. Users cannot configure the unit.

IP Filtering

The IPDU-Sx allows the administrator to block access to the device from certain IP addresses. The IPDU-Sx can accept or drop requests based on the IP filter settings. IP Filtering provides an additional mechanism for securing the IPDU-Sx. Access to the IPDU-Sx network services (SNMP, HTTP(S), SSH, Telnet) can be controlled by allowing or disallowing connections from various IP addresses, subnets, or networks.

Secure Connections

The Remote Power Controller supports secure connections using SSHv2 and HTTPS.

Authentications

The IPDU-Sx supports local authentication with up to 16 character usernames and passwords, and it also supports LDAPv3.

Encryption

The IPDU-Sx supports 256-bit AES encryption.

DEVICE DISCOVERY TOOL

In order to easily locate NTI Devices on a network, the NTI Device Discovery Tool may be used. A link to the Discovery Tool is provided on the web page that appears when you insert the instruction manual CD into your CD ROM drive. Either click on the link or browse the CD to locate the `NTIDiscover.jar` file. The Discover Tool can be run from the CD or it can be saved to a location on your PC. Either way, to open it just double-click on the file `NTIDiscover.jar`. This will open the NTI Device Discovery Tool.

Note: The Device Discovery Tool requires the Java Runtime Environment (version 6 or later) to operate. A copy of Java version 6 is provided on the CD and a link to the web page from which it can be downloaded and installed is also on the CD.

Note: The computer using the Device Discovery Tool and the NTI Device must be connected to the same subnet in order for the Device Discovery Tool to work. If no devices are found, the message “No Devices Found” will be displayed.

Tip: If your Windows program asks which program to open the `NTIDiscover.jar` file with, select the Java program.

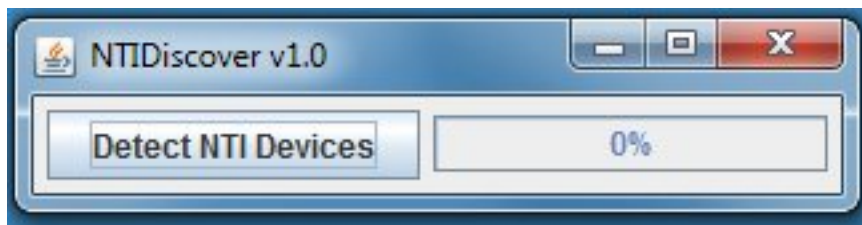

Figure 11- Device Discovery Tool

Click on the “**Detect NTI Devices**” button to start the discovery process. After a short time, the tool will display all NTI devices on your network, along with their network settings.

Device	MAC Address	IP Address	Mask	Gateway		
ENVIROMUX-SEMS-16	00:0C:82:03:03:E8	192.168.3.80	255.255.255.0	192.168.3.3	Submit	Blink LED
ENVIROMUX-5D	00:0C:82:10:00:05	192.168.3.25	255.255.255.0	192.168.3.3	Submit	Blink LED
IPDU-Sx	00:0C:82:08:00:B2	192.168.3.85	255.255.255.0	192.168.3.3	Submit	Blink LED
ENVIROMUX-2DB	00:0C:82:0E:00:08	192.168.3.83	255.255.255.0	192.168.3.3	Submit	Blink LED
VEEMUX-MXN-C5AV	00:0C:82:09:00:25	192.168.3.82	255.255.255.0	192.168.3.3	Submit	Blink LED
VEEMUX-DVI	00:0C:82:07:01:8B	192.168.3.86	255.255.255.0	192.168.3.3	Submit	Blink LED
Submit All Refresh Close						

The “**Blink LED**” button is not supported on the IPDU-Sx

How to Use the Device Discovery Tool

To Change a Device’s Settings, within the row of the device whose settings you wish to change, type in a new setting and click on the **Enter** key, or the **Submit** button on that row. If the tool discovers more than one device, the settings for all devices can be changed and you can click on the **Submit All** button to submit all changes at once.

To Refresh the list of devices, click on the **Refresh** button.

To Blink the LEDs of the unit, click on the **Blink LED** button (**This feature is not supported on the IPDU-Sx.**) The **Blink LED** button will change to a “**Blinking...**” button. The LEDs of the unit will blink until the **Blinking...** button is clicked on, or the NTI Device Discovery Application is closed. The LEDs will automatically cease blinking after 2 hours.

To Stop the LEDs of the unit from blinking, click on the **Blinking...** button. The **Blinking...** button will change to a **Blink LED** button.

OPERATION VIA WEB INTERFACE

A user may monitor and configure the settings of the IPDU-Sx, the outlets, and any sensor connected to it using the Web Interface via any web browser (see page 2 for supported web browsers). To access the Web Interface, connect the IPDU-S2 to the Ethernet (page 5). Use the Device Discovery Tool (page 13) to setup the network settings. Then, to access the web interface controls, the user must log in.

By default, the IPDU-Sx is configured to dynamically assign network settings received from a DHCP server on the network it is connected to. (This can be changed to a static IP address to manually enter these settings in the Network Settings on page 33.) The IPDU-Sx will search for a DHCP server to automatically assign its IP address each time the unit is powered up. If the IPDU-Sx does not find a DHCP server, the address entered into the static IP address field (page 33 -default address shown below) will be used. If a DHCP server on the network has assigned the IP address, use the Device Discovery Tool to identify the IP address to enter when logging in to the IPDU-Sx .

Note: The computer using the Device Discovery Tool and the NTI Device must be connected to the same subnet in order for the Device Discovery Tool to work. If no devices are found, the message “No Devices Found” will be displayed.

Log In and Enter Password

To access the web interface, type the current IP address into the address bar of the web browser. (The default IP address is shown below):

http://192.168.1.22

Note: If “Allow HTTP Access” (page 33) is not checked to be enabled (disabled by default) , only an SSL-encrypted connection will be possible. The software will automatically redirect to an HTTPS (secure) connection. The user will likely see a warning about the SSL certificate and a prompt to accept the certificate. The IPDU-Sx uses a self-signed NTI certificate. Accept the NTI certificate.

A log in prompt requiring a username and password will appear:

The screenshot shows the web interface for the IPDU-S2. At the top left is the NTI logo and 'NETWORK TECHNOLOGIES INCORPORATED'. At the top right, system information is displayed: 'Unit: Unit Name Model: IPDU-S2', 'Uptime: 1 day, 2 hours, 31 mins', and 'Current Time: 09-17-2009 02:55:28 AM'. Below this is a navigation bar with 'Home' and 'Login' links. A 'Support' button is on the left. The main heading is 'IPDU-S2 Secure Remote Power Reboot Switch'. The central form is titled 'Enter login credentials' and contains two input fields: 'Username' with the value 'root' and a hint 'Enter the username to log in with', and 'Password' with masked characters '***' and a hint 'Enter the associated password'. A 'Login' button is positioned below the password field. In the bottom right corner, there is a 'goahead WEBSERVER' logo. The footer contains the copyright notice: 'Copyright © 2009 Network Technologies Inc. All rights reserved.'

Figure 12- Login prompt to access web interface

Username = root

Password = nti

(lower case letters only)

Note: usernames and passwords are case sensitive

With a successful log in, the “Summary” page with a menu at left will appear on the screen:

The screenshot shows the NTI Network Technologies Incorporated interface. At the top right, it displays: Unit: Unit Name Model: IPDU-S2, Uptime: 8 days, 20 hours, 05 mins, Current Time: 11-20-2009 11:55:19 AM. A navigation menu on the left includes Monitoring, Administration, Log, Support, and Logout. The main content area is titled 'Summary' and contains three tables:

Power Outlets					
Num.	Description	Type	Mode	Status	Action
1	Server Power	Power Outlet	Associated	On	View Edit Turn Off Cycle
2	Power Outlet 2	Power Outlet	Associated	On	View Edit Turn Off Cycle

Sensors					
Conn.	Description	Type	Value	Status	Action
1	Server Rack Temperature	Temperature Combo	78.9F	Normal	View Edit Delete
1	Server Rack Humidity	Humidity Combo	29.9%	Normal	View Edit Delete
2	Server Rack Water Sensor	Water	Open	Normal	View Edit Delete

IP Devices					
Num.	Description	Type	Value	Status	Action
1	ENVIROMUX-SEMS Web Demo Unit	IP Device	Responding	Normal	View Edit Delete

Copyright © 2009 Network Technologies Inc. All rights reserved.

Figure 13- Summary page

From this initial page, the user can use the menu to the left to manage all the functions of the IPDU-Sx.

Function	Description
MONITORING	Monitor the sensors, outlets, and IP devices of the IPDU-Sx (below)
ADMINISTRATION	Configure all system, network, multi-user access, and security settings as well as upgrade firmware (page 30)
LOG	View and configure the Event and Data Logs (page 53)
SUPPORT	Links for downloading a manual, the MIB file, or firmware upgrades
LOGOUT	Log the user out of the IPDU web interface

Monitoring

Under Monitoring, there are links to view the status of the sensors, outlets and IP Devices being monitored by the IPDU-Sx.

Link	Description
Summary	Lists all items being monitored, including their description, type, value, and status
Power Outlets	Provides a link to view the status of only the Power Outlets in the IPDU-Sx (page 17)
Line Monitor	Provides a link to view the status of the AC line supplying power to the outlets (IPDU-S4 and -S8 only)
Sensors	Provides a link to view the status of only the Sensors and a link to add them (page 22)
IP Devices	Provides a link to view the status of only the IP Devices and a link to add them (page 25)
Events	Provides a link to view the status of pre-configurable events that would generate alerts (page 28) (IPDU-S4 and -S8 only)

NTI NETWORK TECHNOLOGIES INCORPORATED

Unit: desk Model: IPDU-Sx
Uptime: 6 hours, 39 mins
Current Time: 01-23-2012 04:39:36 PM

Home > Summary

Monitoring

- Summary
- Power Outlets
- Line Monitor
- Sensors
- IP Devices
- Events

Administration

- Log

Summary

Power Outlets

Num.	Description	Type	Mode	Status	Action
1	Power Outlet 1	Power Outlet	Associated	On	View Edit Turn Off Cycle
2	Power Outlet 2	Power Outlet	Associated	Off	View Edit Turn On Cycle
3	Power Outlet 3	Power Outlet	Manual	Off	View Edit Turn On Cycle
4	Power Outlet 4	Power Outlet	Associated	On	View Edit Turn Off Cycle
5	Power Outlet 5	Power Outlet	Associated	Off	View Edit Turn On Cycle
6	Power Outlet 6	Power Outlet	Manual	Off	View Edit Turn On Cycle
7	Power Outlet 7	Power Outlet	Manual	Off	View Edit Turn On Cycle
8	Power Outlet 8	Power Outlet	Associated	Off	View Edit Turn On Cycle

Line Monitor

No.	Description	Type	Value	Status	Action
1	Line Voltage	Voltage	116.4V	Normal	View Edit
2	Total Outlet Current	Current	0.0A	Normal	View Edit
3	Line Frequency	Frequency	60.0Hz	Normal	View Edit
4	Circuit Breaker	Breaker	Closed	Normal	View Edit

Sensors

Conn.	Description	Type	Value	Status	Action
1	temperature	Temperature Combo	29.0C	Normal	View Edit Delete
1	humidity	Humidity Combo	22.3%	Normal	View Edit Delete
2	water	Water	Open	Normal	View Edit Delete

IP Devices

Num.	Description	Type	Value	Status	Action
------	-------------	------	-------	--------	--------

Copyright © 2010 Network Technologies Inc. All rights reserved.

Figure 14- Summary page and the Monitoring menu

From the Summary page, the user can view the status of all power outlets, sensors, and the IP Devices being monitored by the IPDU-Sx. Each item listed has a link that when selected will open the status page for that item.

Power Outlet 1 Status

Type: Power Outlet

On

Mode: Manual

Operate Outlet:

Figure 15- Status page for a power outlet

If the power outlet is in alert status, the user has the option to either **acknowledge** the alert or **dismiss** it. If the user acknowledges the alert, no additional alert messages will be sent during that alert status cycle. If the user dismisses the alert, another alert message will be sent once the "notify again after" time designated on the configuration page (page 23) elapses.

If the user wants to change the ON/OFF status of an outlet, an option to perform that function is provided. Toggle the status desired in the window provided, and click **Apply Changes**.

A **Configure** button at the bottom of each page allows the user (administrators only) to configure parameters of the power outlet.

Configure a Power Outlet

The Power Outlet Configuration page allows the user to apply settings to control how or if alert messages are sent in the event the outlet changes state. The user can open the Power Outlet Configuration page by clicking on the Configure button at the bottom of the Power Outlet Status page (page 16) or by clicking on Edit from the Summary page.

Power Outlet Configuration

The screenshot displays the 'Power Outlet Configuration' interface. It features three main sections: 'Power Outlet Settings', 'Notification Settings', and 'Outlet Operation Settings'. The 'Power Outlet Settings' section includes a 'Description' field with the value 'Power Outlet 1' and a 'Group' dropdown menu set to '1'. Below these fields is a 'Save' button. A callout box with an arrow points to the '+' icon next to the 'Outlet Operation Settings' heading, with the text 'click to expose more settings'.

Figure 16- Power Outlet Configuration page

The Power Outlet Configuration page is broken into three sections; Power Outlet Settings, Notification Settings and Outlet Operation Settings. To explode the window to see Notification Settings or Outlet Operation Settings (Figure 17), click on the section heading (Figure 16).

Notification Settings	
Disable Notifications	<input type="checkbox"/> Disable notifications for this outlet
Enable Syslog Notifications	<input checked="" type="checkbox"/> Send notifications via syslog when this outlet's status changes
Enable SNMP Traps	<input checked="" type="checkbox"/> Send notifications via SNMP traps when this outlet's status changes
Enable E-mail Notifications	<input checked="" type="checkbox"/> Send notifications via e-mail when this outlet's status changes
E-mail Subject	<input type="text" value="power1"/> Subject of e-mails sent for status changes
Enable SMS Alerts	<input checked="" type="checkbox"/> Send alerts for this sensor via sms

This field only found in IPDU-S4 and IPDU-S8

Outlet Operation Settings	
Operation Mode	<input type="text" value="Associated"/> Select the operation mode for this outlet
Manual Operation Changes Mode	<input type="checkbox"/> Manually operating the outlet forces outlet into <i>manual</i> mode
Cycle Duration	<input type="text" value="30"/> Duration the outlet is off during a manual or associated power cycle (1-300 seconds)
Periodic Cycle Duration	<input type="text" value="1"/> <input type="text" value="Min"/> Duration the outlet is off during a periodic power cycle
Periodic Type	<input type="text" value="None"/> If operation mode is periodic, choose the type of periodic schedule
Periodic Hour	<input type="text" value="0"/> Hour for the periodic operation (00-23)
Periodic Minute	<input type="text" value="0"/> Minute for the periodic operation (00-59)
Periodic Day	<input type="text" value="0"/> Day for the periodic operation (one-time & monthly: 1-31, weekly: Sun=1 Mon=2 ... Sat=7)
Periodic Month	<input type="text" value="NA"/> Month for the periodic operation (only used for one-time mode)
Periodic Year	<input type="text" value="0"/> Year for the periodic operation (only used for one-time mode)
Default Outlet Value	<input type="text" value="Off"/> Default outlet value during power on
Multiple event preferred value	<input type="text" value="Off"/> Preferred outlet state when multiple events operate same outlet

Figure 17- More settings for Power Outlet Configuration

Power Outlet Settings		Description
Description		The description of the outlet that will be viewed in the Summary page and in the body of alert messages
Group		Assign the outlet to either group 1 or 2
Notification Settings		
Disable Notifications		Place a checkmark in the box to prevent notifications from being sent when this outlet's status changes
Enable Syslog Notifications		Place a checkmark in this box to have alert notifications sent via Syslog messages
Enable SNMP traps		Place a checkmark in this box to have alert notifications sent via SNMP traps (v2c)
Enable Email Notifications		Place a checkmark in this box to have alert notifications sent via Email
Email Subject		Enter the subject to be viewed when an email alert message is received
Enable SMS Alerts (IPDU-S4 / -S8 only)		Place a checkmark in this box to have alert notifications sent via SMS message (requires modem)
Outlet Operation Settings		
Operation Mode		Choose between Manual, Periodic, or Associated operating modes for the outlet
Manual Operation Changes Mode		Place a checkmark here if you want the operating mode to be forced into Manual mode if you manually override the outlet status from the Power Outlet Status page (page 16)
Cycle Duration		Time period (1-300 seconds) the outlet will remain OFF during a manual power cycle or an associated power cycle
Periodic Cycle Duration		Time period in minutes or hours the outlet will remain OFF during a periodic power cycle
Periodic Type		If the operation mode is set to periodic, choose the type of periodic schedule between one time, daily, weekly, monthly, or none
Periodic Hour		Choose which hour of the day for the periodic cycle to occur (00-23)
Periodic Minute		Choose the minute within the hour of the day for the periodic cycle to occur (00-59)
Periodic Day		Choose the day for the periodic cycle to occur (for one-time and monthly settings, enter a value between 1-31; for weekly setting, enter a value 1-7, Sun = 1, Mon=2Sat = 7)
Periodic Month		Choose which month of the year for the periodic cycle to occur. This only applies when the Periodic Type is set to "one time".
Periodic Year		Enter the year for the periodic cycle to occur. This only applies when the Periodic Type is set to "one time".
Default outlet value		Choose the state of the outlet at power-On of the IPDU- Outlet ON or Off
Multiple Event Preferred Value		Choose the preferred outlet state when more than one event can control the outlet (if one event is configured to turn the outlet OFF, and another event to turn the outlet ON, this setting will decide the state of the outlet)

Note: Alerts are also indicated by illuminated LEDs on the front of the IPDU-Sx (page 7).

More about Groups

Groups are used to create a common relationship between sensors, IP devices, power outlets, etc. and their alert messages. All items being monitored are assigned to either group 1 or group 2. All users (a maximum number of 16 including the root user) can either receive alert messages from items in group 1, group 2, both groups, or neither.

Be sure to press the **Save** button to save the configuration settings.

More about Operation Modes

In Manual Mode, the outlet will only power cycle when it is performed through the Power Outlet Status page or through the text menu.

In Periodic Mode, the outlet will power cycle based on the settings configured as described in the table above.

In Associated Mode, the outlet can be controlled based on the alert status of a sensor or IP address. When configured to do so (page 24), the outlet can be powered ON or OFF when a sensor is in alert mode, and/or when it returns to normal state, or power cycled when an IP Device is in alert mode.

Note: An outlet configured for Associated or Periodic operating mode can be manually powered ON/OFF. If "Manual Operation Changes Mode" (above) is checked, manually changing the ON/OFF state of an outlet configured for Associated Mode or Periodic Mode will change the operating mode to Manual Mode until the outlet is reconfigured.

Line Monitor

The Line Monitor on the Summary Page provides a quick way to view the amount of power that is being used by the IPDU-S4 or IPDU-S8. From the Summary Page the user will find displayed:

- **Line Voltage Status-** the value of the voltage being supplied
- **Total Outlet Current Status-** the total amount of current being used by all of the outlets combined (also viewed in the LED display on the front of the IPDU-S4 and IPDU-S8)
- **Line Frequency Status-** the frequency of the power being supplied
- **Circuit Breaker Status-** the status of the circuit breaker on the rear of the unit.

Line Voltage Status

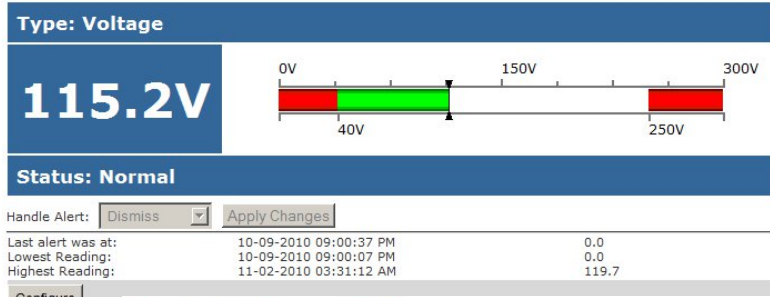

Total Outlet Current Status

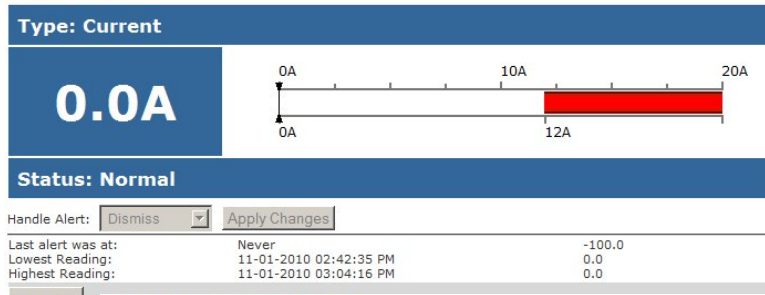

Line Frequency Status

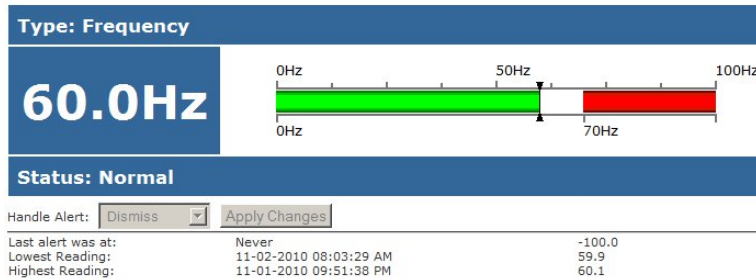

Circuit Breaker Status

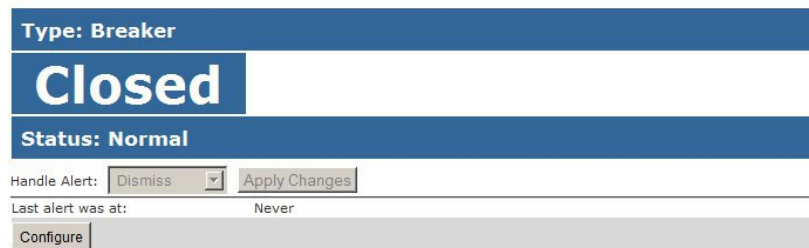

Figure 18- Line Monitor Categories

Each category of line monitoring is configurable much like sensors are configured. For more on configuration, see “Monitor and Configure Sensors” on next page.

Voltage Configuration

The screenshot displays a web-based configuration interface for voltage monitoring. It features a main container with four expandable sections, each indicated by a plus sign icon in a small square. The sections are: "Line Monitor Parameters Settings", "Alert Settings", "Data Logging", and "Power Outlet Association". Below these sections is a "Save" button.

Figure 19- Configuration Categories

Monitor and Configure Sensors

To view the graphic image showing the status of a sensor, click on the sensor description in the Summary page. From the sensor status page, the user can view a current reading, either dismiss or acknowledge an alert, or open the sensor configuration page (if the user has administrative privileges).

Undefined #1 Status

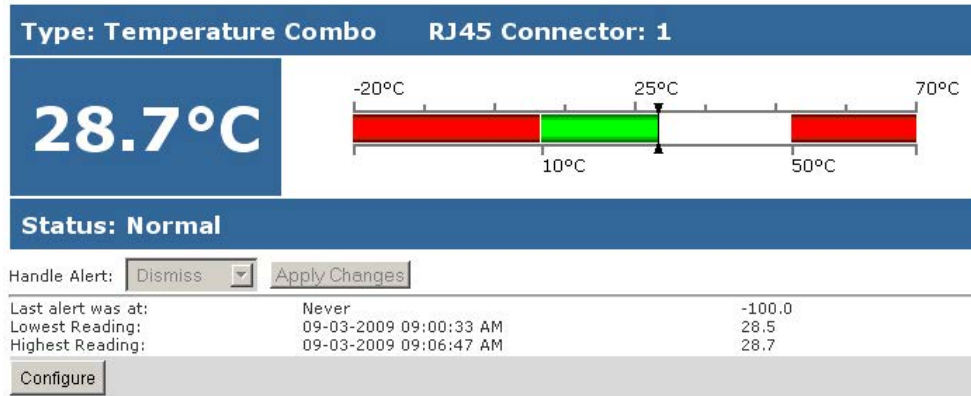

Figure 20- Sensor Status page

The administrative user can open the sensor configuration page by clicking on the **Configure** button at the bottom of the sensor status page (above) or by clicking on **Edit** from the Summary page. From the sensor configuration page the user can apply settings to control how or if alert messages are sent in the event the sensor is in alert status, threshold settings, data logging settings, and power outlet association.

Temperature Combo Configuration

- **Sensor Settings**

Description	Undefined #1
	Descriptive name for the sensor
Group	1
	Select which group the sensor belongs to
Units	Deg. C
	Select the units for the sensor
Min. Level	-20.0
	Min. supported value for the sensor
Max. Level	70.0
	Max. supported value for the sensor
Sampling Period	10 Sec
	Sampling period for the sensor
Min. Threshold	10.0
	Min. threshold below which indicates an alert condition
Max. Threshold	50.0
	Max. threshold above which indicates an alert condition

+ **Alert Settings**

+ **Data Logging**

+ **Power Outlet Association**

Figure 21- Sensor Configuration page

The Sensor Configuration page is broken into four sections; Sensor Settings, Alert Settings and Data Logging, and Power Outlet Association. To explore the window to see settings for a section, click on the section heading (Figure 21).

The screenshot displays the 'Sensor Configuration' page, which is organized into four main sections: Alert Settings, Data Logging, Power Outlet Association, and a Save button at the bottom left.

- Alert Settings:** This section contains several configuration options:
 - Disable Alerts:** A checkbox that is currently unchecked. Description: 'Disable alert notifications for this sensor'.
 - Alert Delay:** A text input field containing '30' and a dropdown menu set to 'Sec'. Description: 'Duration the sensor must be out of thresholds before alert is generated'.
 - Notify Again Time:** A text input field containing '4' and a dropdown menu set to 'Hr'. Description: 'Time after which alert notifications will be sent again'.
 - Notify on return to normal:** A checked checkbox. Description: 'Send a notification when this sensor returns to normal status'.
 - Auto acknowledge:** A checked checkbox. Description: 'Automatically acknowledge alert when sensor returns to normal status'.
 - Enable Syslog Alerts:** A checked checkbox. Description: 'Send alerts for this sensor via syslog'.
 - Enable SNMP Traps:** An unchecked checkbox. Description: 'Send alerts for this sensor via SNMP traps'.
 - Enable E-mail Alerts:** A checked checkbox. Description: 'Send alerts for this sensor via e-mail'.
 - E-mail Subject:** A text input field containing 'Lab Temperature Alert'. Description: 'Subject of e-mails sent for alerts'.
 - Enable SMS Alerts:** An unchecked checkbox. Description: 'Send alerts for this sensor via sms'. A callout box with an arrow points to this field, stating: 'This field only found in IPDU-S4 and IPDU-S8'.
- Data Logging:** This section contains:
 - Add to data log:** A checked checkbox. Description: 'Add readings to the data log'.
 - Logging Period:** A text input field containing '60' and a dropdown menu set to 'Sec'. Description: 'Frequency at which readings are added to the data log.'
- Power Outlet Association:** This section contains:
 - Associated Outlet:** A dropdown menu showing '(S2)Power Outlet 2'. Description: 'Which outlet should be associated with this sensor'.
 - Alert State:** A dropdown menu set to 'Off'. Description: 'On alert, set the outlet state to this'.
 - Normal State:** A dropdown menu set to 'On'. Description: 'On return to normal, set the outlet state to this'.

A 'Save' button is located at the bottom left of the configuration area.

Figure 22- Sensor Configuration- full view of settings

Sensor Settings	
Description	Description
Description	The description of the sensor that will be viewed in the Summary page and in the body of alert messages
Group	Assign the sensor to either group 1 or 2 (see also page 45)
Units	This lets the operator choose between Celsius and Fahrenheit as the temperature measurement unit.
Min. Level	Displays the minimum value that this sensor will report
Max. Level	Displays the maximum value that this sensor will report
Sampling Period	Determines how often the displayed sensor value is refreshed on the Sensor page. A numeric value and a measurement unit (minimum 1 seconds, maximum 999 minutes) should be entered.
Minimum Threshold	The user must define the lowest acceptable value for the sensors. If the sensor measures a value below this threshold, the sensor will move to alert status. The assigned value should be within the range defined by Minimum Level and Maximum Level and lower than the assigned Maximum Threshold value. If values out of the range are entered, and error message will be shown.
Maximum Threshold	The user must define the highest acceptable value for the sensors. If the sensor measures a value above this threshold, the sensor will move to alert status. The assigned value should be within the range defined by Minimum Level and Maximum Level and higher than the assigned Minimum Threshold value. If values out of the range are entered, and error message will be shown.
Alert Settings	
Disable Alerts	Place a checkmark in the box to prevent alerts from being sent when this sensor's status changes
Alert Delay	The alert delay is an amount of time the sensor must be in an alert condition before an alert is sent. This provides some protection against false alarms. The Alert Delay value can be set for 0-999 seconds or minutes.
Notify Again Time	Enter the amount of time in seconds, minutes, or hours (1-999) before an alert message will be repeated
Notify on Return to Normal	The user can also be notified when the sensor readings have returned to the normal range by selecting the " Notify when return to normal " box for a sensor.
Auto Acknowledge	Place a checkmark in this box to have alert notifications in the summary page return to normal state automatically when sensor readings return to normal.
Enable Syslog Alerts	Place a checkmark in this box to have alert notifications sent via Syslog messages
Enable SNMP traps	Place a checkmark in this box to have alert notifications sent via SNMP traps (v2c)
Enable Email Alerts	Place a checkmark in this box to have alert notifications sent via Email
Email Subject	Enter the subject to be viewed when an email alert message is received
Enable SMS Alerts (IPDU-S4 / -S8 only)	Place a checkmark in this box to have alert notifications sent via SMS messages (required modem)
Data Logging	
Add to data log	This is a check-box that lets the user decide if the data sampled should be recorded in the Data Log.
Logging Period	Enter the time period between logged measurements
Power Outlet Association	
Associated outlet	Select which outlet (if any) will be powered ON or OFF when the sensor is in an alert state. For this to take effect, the outlet must be configured for Associated Operation Mode (page 19)
Alert State	State the outlet should be in when the sensor enters an alert state
Normal State	State the outlet should be in when the sensor returns to normal state

Be sure to press the **Save** button to save the configuration settings.

Monitor IP Devices

IP devices such as servers, routers, cameras, etc. can be monitored to make sure network connections are open to them. In order to monitor an IP Device the devices must be added to the list of IP Devices being monitored. From the **Monitoring** section of the menu, click on **IP Devices**. A page listing IP Devices being monitored will open, with a link to add IP Devices. Click on **Add New IP Device**.

IP Devices

IP Devices					
Num.	Description	Type	Value	Status	Action
Add New IP Device					

Figure 23- IP Devices listing-none monitored yet

The page shown below will open. Enter a description for the new IP Device and the IP Address of the device.

Add New IP Device

[-] Add New IP Device

Description	
	Descriptive name for the IP Device
IP Address	
	IP Address of the device to ping

Figure 24- Add New IP Device page

With the address is entered in the block, click on the **“Add”** button.

The IP Device Configuration page will immediately open. Here you can configure the IPDU-Sx to ping the IP Device as often as desired and to react to a lack of response by sending alert messages and/or power-cycling a power outlet.

IP Device Configuration

- IP Device Settings

Description	ENVIROMUX-MINI no.1	Descriptive name for the IP Device
IP Address	10.0.1.15	IP Address of the device to ping
Group	1 ▼	Select which group the device belongs to
Ping Period	10	Min ▼
Timeout	2	Duration, in seconds, to wait for a response to a ping
Retries	10	The number of tries before device is considered in alarm

+ Alert Settings

+ Data Logging

+ Power Outlet Association

Save

Figure 25- IP Device Configuration page

IP Device Settings	Description
Description	The description of the IP Device that will be viewed in the Summary page and in the body of alert messages
IP Address	The IP address of the IP Device
Group	Assign the IP Device to either group 1 or 2
Ping Period	Enter the frequency in minutes or seconds that the IPDU-S2 should ping the IP Device
Timeout	Enter the length of time in seconds to wait for a response to a ping before considering the attempt a failure
Retries	Enter the number of times the IPDU-S2 should ping a non-responsive IP device before changing its status from normal to alarm and sending an alert

The alert settings and data logging are the same as for sensor configuration, described on page 24. Under Power Outlet Association, if the IP device is connected to one of the power outlets on the IPDU-Sx, the IPDU-Sx can automatically cycle the power to the chosen outlet when the IP device is determined to be in a state of alarm. The power cycle characteristics will be those configured under the power outlet configuration under “Outlet Operation Settings” (page 19).

Power Outlet Association

Associated Outlet	<div style="border: 1px solid #ccc; padding: 2px;"> None <div style="border: 1px solid #ccc; padding: 2px; margin-top: 2px;"> None Power Outlet 1 Power Outlet 2 </div> </div>	<small>be associated with this IP Device</small>
--------------------------	--	--

Figure 26- Power Outlet Association for IP Device

With a couple of IP devices having been configured for monitoring, the IP Device list will provide links to them for viewing their status, editing their configuration, or deleting them from the list.

IP Devices

IP Devices					
Num.	Description	Type	Value	Status	Action
1	ENVIROMUX-MINI-no.1	IP Device	Responding	Normal	View Edit Delete
2	ENVIROMUX-MINI-no.2	IP Device	Responding	Normal	View Edit Delete

[Add New IP Device](#)

Figure 27- IP Device list with new devices added

To view the graphic image showing the status of an IP address, click on the IP Device description or click **View**. From the IP Device status page, the user can view the current status, either dismiss or acknowledge an alert, or open the IP Device configuration page (if the user has administrative privileges). If you have found the device to be in an alert state and have either dismissed or acknowledged it, be sure to click the **Apply Changes** button.

ENVIROMUX-MINI no.1 Status

Type: IP Device

Responding

Status: Normal

Handle Alert: Dismiss [Apply Changes](#)

Last alert was at: Never

Configure

Figure 28- IP Device Status page

Monitor Events

The IPDU (models IPDU-S4 and IPDU-S8 only) can be configured to respond to predefined events. Once the criteria is set for what constitutes an event, an alert can be sent and/or devices connected to outlets can be controlled. Up to 50 events can be configured.

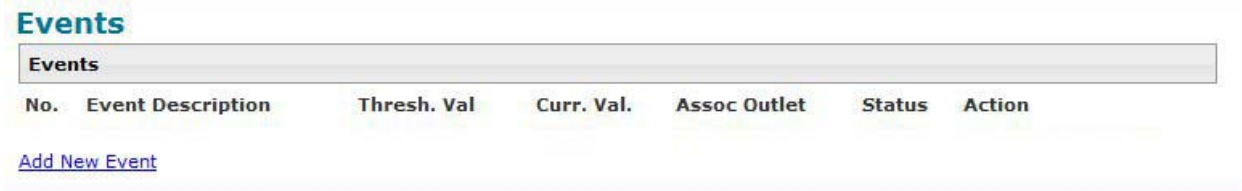

Figure 29- Event Monitoring

From the Events list, select “Add New Event”. A page with a drop-down list of available sensors to choose from is presented. Select the sensor you want to use to send an alert if specific conditions are reached.

Add New Event

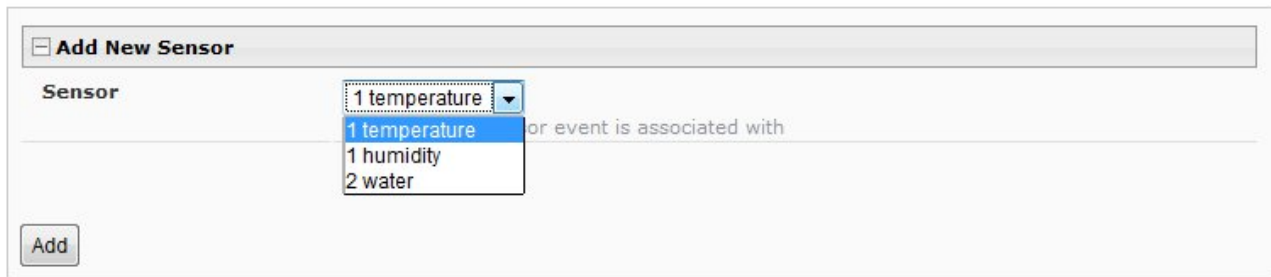

Figure 30- Add New Event

A configuration page will appear with fields for determining under what circumstances you should receive an alert from a sensor and what, if anything should be done about it.

The settings applied here have no bearing on the sensor configuration settings applied when the sensor is setup (page 23). These settings only apply to the event being configured.

Many of the same fields described in the sensor configuration page (page 24) are used for event configuration.

Event descriptions can be anything you want, up to 80 characters in length. These descriptions will appear in the Event Log when events are recorded.

Note: Once you open the “New Event Configuration” page for an event, that event will be added to the list of events (next page). To remove the event, see next page.

New Event Configuration

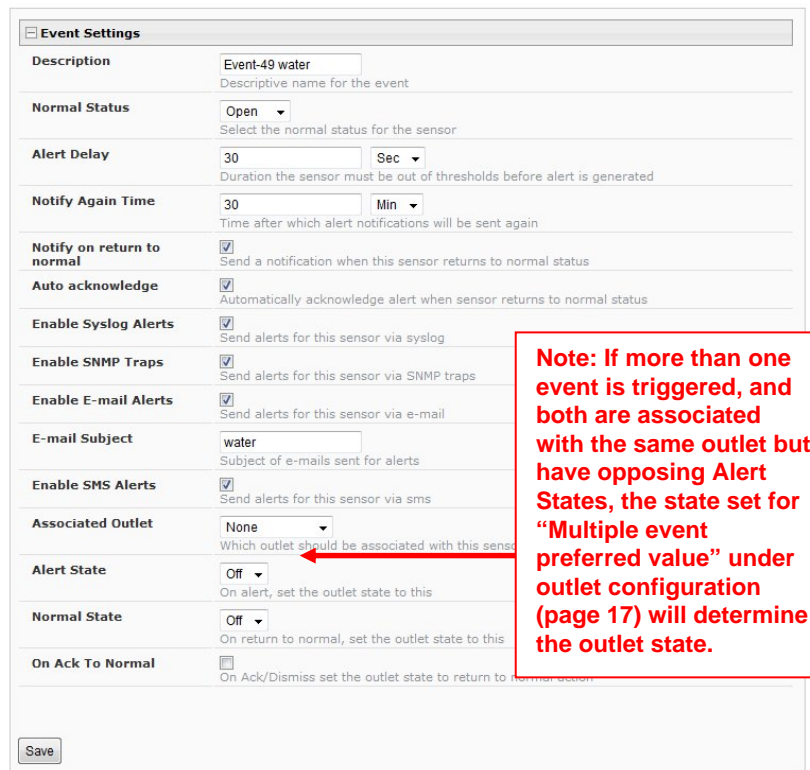

Figure 31- Configure New Event

Once events are configured, they are listed and numbered for monitoring and easy adjustment. Up to 50 can be configured.

Events

Events						
No.	Event Description	Thresh. Val	Curr. Val.	Assoc Outlet	Status	Action
1	temperature	30.0C(Max)	30.5C	Power Outlet 4	Alarm	Ack Dismiss Delete
2	temperature	32.0C(Max)	30.5C	Power Outlet 1	Normal	Ack Dismiss Delete
3	temperature	40.0C(Max)	30.5C	Power Outlet 2	Normal	Ack Dismiss Delete
4	temperature	45.0C(Max)	30.5C	Power Outlet 3	Normal	Ack Dismiss Delete
5	temperature	50.0C(Max)	30.5C	Power Outlet 4	Normal	Ack Dismiss Delete
6	temperature	30.0C(Min)	30.5C	Power Outlet 5	Normal	Ack Dismiss Delete
7	temperature	35.0C(Max)	30.5C	Power Outlet 1	Normal	Ack Dismiss Delete

[Add New Event](#)

Copyright © 2010 Network Technologies Inc. All rights reserved.

Figure 32- List of Configured Event

If an event is triggered, the Status will change from “Normal” to “Alarm”. Whatever reaction that has been configured as a result of this event will be activated.

The user will have the option to either Acknowledge the alert, Dismiss it, or Delete the configuration of the event altogether. If the user acknowledges the alert, no additional alert messages will be sent during that alert status cycle. If the user dismisses the alert, another alert message will be sent once the “notify again after” time designated on the configuration page elapses.

To see the status page for a sensor, click on the link under “Curr. Val.”. To see the status of an associated outlet, click on the link under “Assoc Outlet”.

To delete an event configuration, select “Delete” to the far right of the event number. That configuration will be removed and the one following it (if any) will move up to that event number.

Note: Removal of a sensor from the IPDU will also remove all configured events associated with that sensor.

Click on the description for an event to open the configuration page for editing.

temperature Configuration

Event Settings

Description	temperature	<small>Descriptive name for the event</small>
Units	Deg. C	<small>Select the units for the sensor</small>
Threshold	40.0	<small>Threshold which indicates an alert condition</small>
Threshold Type	Max	<small>Select the threshold type</small>
Alert Delay	10	<small>Duration the sensor must be out of thresholds before alert is generated</small>
Notify Again Time	30	<small>Time after which alert notifications will be sent again</small>
Notify on return to normal	<input checked="" type="checkbox"/> <small>Send a notification when this sensor returns to normal status</small>	

Figure 33- Adjust settings for events

All settings for an event can be adjusted as needed. Be sure to click “Save” before exiting.

Administration

Monitoring
Administration
System
Enterprise
Network
Cascade
Users
Security
System Information
Firmware
Reboot
Log
Support
Logout

From the Administration section there are several sub sections for configuring the IPDU-S2:

System	Fields for applying time zone, date, time, NTP server, and backup and restore configuration settings
Enterprise	Fields for assigning the unit name, address, contact person, the IPDU-S2 e-mail address, and phone number of a contact person
Network	Fields for providing all the network settings the IPDU-Sx including IP address, DNS, SMTP and SNMP settings
Cascade	Fields for configuring this IPDU to control multiple IPDUs or be controlled by another IPDU- (models IPDU-S4 and IPDU-S8 only)
Users	Fields for assigning users, access privileges, passwords, contact settings, and schedule settings
Security	Fields for setting authentication method and IP Filtering
System Information	For viewing IPDU-Sx system information
Firmware	For updating the firmware of the IPDU-Sx when improved software becomes available.
Reboot	Enables user to reboot the IPDU-Sx using the web interface

System Configuration

The System Configuration section is where all the settings necessary for proper time reporting within alert messages and log records are configured. To view the System Configuration page, click on **System** from the **Administration** section of the menu.

System Configuration

[-] Time Settings

Time zone (GMT-05:00) Eastern Time (US & Canada)
Select your time zone

Enable Daylight Saving Automatically adjust clock for daylight saving changes

Set Date
Manually set the system date (format MM-DD-YYYY)

Set Time AM
Manually set the system time (format hh:mm:ss)

Enable NTP Get system time via Network Time Protocol

NTP server
Address of the NTP server

NTP Frequency 5
Frequency, in minutes, at which to query NTP server (minimum 5 minutes)

[-] Configuration Backup & Restore

Choose File Browse...
Choose configuration file to restore.
 Note: system will reboot to apply the configuration.

Download Configuration File

Restore Defaults

Save

Figure 34- System Configuration page

The Date and Time of the IPDU-Sx can be either manually setup to use an onboard clock or set to be synchronized with an NTP server. The configuration of the IPDU-Sx can also be easily backed up to a file on your PC and restored from that file as needed.

Time Settings	Description
Time Zone	Enter the appropriate time zone
Enable Daylight Saving	Apply a checkmark to have the time change according to Daylight Saving Time rules
Set Date	Enter the system date in MM-DD-YYYY format
Set Time	Enter the system time of day in hh:mm:ss format
Enable NTP	Place a checkmark to enable the IPDU-Sx to automatically sync up with a time server via NTP
NTP server	If the NTP is enabled, enter the IP address of the NTP server
NTP Frequency	Enter the frequency (in minutes) for the IPDU-Sx to query the NTP server (minimum is 5 minutes)
Configuration Backup & Restore	
Choose file	<p>Browse for a saved configuration file to be restored to the IPDU-Sx. After selection, press the "Save" button and the IPDU-Sx will restore the configuration settings and reboot. Allow 1 minute before trying to reconnect and log in again.</p> <p>Note: The IP address will be set to the IP address in the file and may be different</p>
Download Configuration File	Click this button to save the configuration of the IPDU-Sx to a location on your PC. This file can be restored using the "Choose file" field in the event you wish to return the IPDU-Sx to a former state
Restore Defaults	<p>Click this button to restore the IPDU-Sx to the configuration settings it had upon receipt from the factory. Be careful! This will erase <u>all</u> user configuration settings. Upon restoration, the IPDU-Sx will reboot. Allow 1 minute before trying to reconnect and log in again.</p> <p>Confirmation is required.</p>

Note: If "Restore Defaults" is used, the IP address will also be restored to its default address of 192.168.1.22 with a login name "root" and password "nti". To restore the root password to "nti" without having to restore all default settings, contact NTI for assistance.

To identify the IP address of the IPDU-Sx without restoring defaults, use the Discovery Tool (page 13).

Click on **Save** when finished with Time Setting changes.

Enterprise Configuration

The Enterprise Configuration page is used to enter basic company information to be applied to the body of alerts. To view the Enterprise Configuration, click on **Enterprise** from the **Administration** section of the menu. Enter in the blocks your unit name, location, the contact person that alert e-mails should refer to, the phone number to reach that person, and the e-mail address assigned to the IPDU-Sx. Alert message sent via email, syslog and SNMP will include the information in these blocks.

The IPDU-S4 and IPDU-S8 additionally has a section for the GSM modem status. A GSM modem must be installed in order to send SMS messages. If a GSM modem is properly installed (page 8), the type, status, IMEI number, and signal strength will be displayed. The modem will work with a signal strength between -111dBm (weak) and -51dBm (strong). If a modem is not installed, the words "not available" will be displayed instead for the modem type.

Note: It may take several minutes for the GSM modem to be detected by the IPDU-Sx.

Enterprise Configuration

Enterprise Settings

Enterprise Name	<input type="text" value="IPDU-S8"/>	Name to identify this unit
Location	<input type="text" value="ENGINEERING"/>	Location/Address
Contact	<input type="text" value="MIKE"/>	Contact person
Phone	<input type="text" value="111222333"/>	Phone number of contact person
E-mail	<input type="text" value="ipdusx@company.com"/>	E-mail address for messages sent from this unit

GSM Modem Status

Modem Type:	USB Modem
IMEI:	353254030124511,PZ2996N2VN
Modem Status:	Ready
Signal Power:	-97 dBm



GSM modem is properly installed →

Figure 35- Enterprise Configuration

Network Configuration

From the Network Setup page the administrator can either choose to have the IP address and DNS information filled in automatically by the DHCP server (default setting), or manually fill in the fields (use a static address). To view the Network Configuration page, click on **Network** from the **Administration** section of the menu.

Note: When “DHCP” is selected, make sure a DHCP server is running on the network the IPDU-Sx is connected to.

Network Configuration

The screenshot shows the Network Configuration page with the following fields and values:

- Mode:** Static (Method of acquiring IP settings)
- IP Address:** 192.168.1.22 (Statically assigned IP address)
- Subnet Mask:** 255.255.255.0 (Statically assigned subnet mask)
- Default Gateway:** 192.168.1.1 (Statically assigned default gateway)
- Preferred DNS:** 192.168.1.2 (Statically assigned preferred name server)
- Alternate DNS:** 192.168.1.3 (Statically assigned alternate name server)

Below the IP Settings are sections for SMTP Settings, SNMP Settings, Server Settings, IP Alias 1 Settings, IP Alias 2 Settings, and IP Alias 3 Settings. A 'Save' button is located at the bottom left.

Note: The values shown here are for local (static) address configuration only.

Address values for DHCP configuration will only be displayed in the System Information page (page 50).

Only applicable to IPDU-S4/S8 models- firmware version 1.4 or later.

Figure 36- Network Configuration page

IP Settings	Description
Mode	Select between Static (manual) , or DHCP (automatic IP and DNS) settings (DHCP is the default setting)
IP Address	Enter a valid IP address (default address shown above)
Subnet Mask	Enter a valid subnet mask (default value shown above)
Default Gateway	Enter a valid gateway (default gateway shown above)
Preferred DNS	Enter a preferred domain name server address
Alternate DNS	Enter an alternate domain name server address

For descriptions of SMTP, SNMP, and Server Settings, see page 35.

The Network Configuration page is broken into seven sections; IP Settings, SMTP Settings, SNMP Settings, Server Settings, and IP Alias 1, 2, and 3 Settings. To explode the window to see settings for a section, click on the section heading.

Network Configuration

+ IP Settings	
- SMTP Settings	
SMTP Server	smtp.gmail.com <small>SMTP server used when sending e-mails</small>
Port	587 <small>SMTP server port</small>
Use SSL	<input type="checkbox"/> <small>SMTP server requires the use of SSL</small>
Use TLS	<input checked="" type="checkbox"/> <small>SMTP server requires the use of TLS</small>
Use Authentication	<input checked="" type="checkbox"/> <small>SMTP server requires authentication to send e-mail</small>
Username	username <small>Username for sending e-mails</small>
Password	•••••••• <small>Password for sending e-mails</small>
- SNMP Settings	
Enable SNMP Agent	<input checked="" type="checkbox"/> <small>Allow access to SNMP agent on this device</small>
Enable SNMP Traps	<input checked="" type="checkbox"/> <small>Enable sending of SNMP traps from this device</small>
Read-write community name	private <small>Read-write community name for SNMP agent</small>
Read-only community name	public <small>Read-only community name for SNMP agent</small>
- Server Settings	
Enable Telnet	<input type="checkbox"/> <small>Enable access to this device via telnet</small>
Enable SSH	<input checked="" type="checkbox"/> <small>Enable access to this device via ssh</small>
Enable HTTP Access	<input type="checkbox"/> <small>Enable access to this device via standard (non-secure) HTTP requests. HTTPS is always enabled.</small>
HTTP Port	80 <small>Port for standard HTTP requests</small>
HTTPS Port	443 <small>Port for HTTPS requests</small>
Web Timeout	0 <small>Minutes after which idle web users will be logged out (0 disables idle logout)</small>
+ IP Alias 1 Settings	
+ IP Alias 2 Settings	
+ IP Alias 3 Settings	
Save	

Common Port numbers:
Default: 25 (Not secure)
SSL: 465 (Secure)
TLS: 587 (Secure)
Contact your network administrator for required settings.

Figure 37- Network Configuration- more settings

More Network Settings (see Figure 37)

SMTP Settings	Description
SMTP Server	Enter a valid SMTP server name (e.g. yourcompany.com)
Port	Enter a valid port number (default port is 25)
Use SSL	Place a checkmark in the box if the SMTP server supports SSL
Use TLS	Place a checkmark in the box if the SMTP server supports TLS
Use Authentication	Place a checkmark in the box if the SMTP server requires authentication to send email
Username	Enter a valid username to be used by the IPDU-Sx to send emails
Password	Enter a valid password assigned to the IPDU-Sx username
SNMP Settings	
Enable SNMP agent	Place a checkmark in the box to enable access to the SNMP agent
Enable SNMP traps	Place a checkmark in the box to allow SNMP traps to be sent
Read- write community name	Enter applicable name (commonly used- "private") CASE SENSITIVE
Read- only community name	Enter applicable name (commonly used- "public") CASE SENSITIVE
Server Settings	
Enable Telnet	Place a checkmark in the box to enable access to the IPDU-Sx via Telnet
Enable SSH	Place a checkmark in the box to enable access to the IPDU-Sx via SSH
Enable HTTP access	Place a checkmark in the box to enable access to the IPDU-Sx via standard (non-secure) HTTP requests Don't disable until you read the first two notes below.
HTTP Port	Port to be used for standard HTTP requests
HTTPS Port	Port to be used for HTTPS requests
Web Timeout	Number of minutes after which idle web uses will be logged-out (enter 0 to disable this feature)

Note: When using only a secure access configuration ("Enable HTTP Access" is NOT checked), if you intend to connect to the ENVIROMUX from a location outside the local area network, make sure the firewall on the local area network is configured to allow traffic through the port assigned to HTTPS requests.

Note: If you are installing the ENVIROMUX with a public IP address and intend to use only a secure access configuration, you will need to create an x.509 certificate (page 47) and load it into the ENVIROMUX and any PC that will be required to access the ENVIROMUX.

If the administrator chooses to have the IP and DNS information filled in automatically via DHCP, the SMTP server and port number still need to be entered for email alerts to work. If the SMTP server requires a password in order for users to send emails, the network administrator must first assign a user name and password to the IPDU.

Note: The SMTP server port number is shown in Figure 37 as "25". This is a common port number assigned, but not necessarily the port number assigned to your SMTP server. For SMTP servers that support SSL, the common port number is 465, and for those that support TLS, the common port number is 587.

The administrator may assign a different HTTP Server Port than is used by most servers (80).

Note: If the port number is changed and forgotten, to determine what it has been changed to connect the IPDU-SX for RS232 control (page 6) and review the Network Settings (page 33).

Read-Only Community Name

The SNMP Read-only community name enables a user to retrieve "read-only" information from the IPDU-Sx using SNMP network management software or a MIB browser and a MIB file. This name must be present in the IPDU-Sx and in the proper field in the SNMP software. This name is **case sensitive** so be sure to enter it correctly in the IPDU-Sx as well as in the SNMP software.

Read-Write Community Name

Only applicable to IPDU-S4/S8- Firmware version 1.3 or later
--

The SNMP Read-Write community name enables a user to read information from the IPDU-Sx and to modify settings on the IPDU-Sx using SNMP network management software or a MIB browser and MIB file (MIB file version 1.01 or later). This name must be present in the IPDU-Sx **AND** in the proper field in the SNMP software. This name is **case sensitive** so be sure to enter it correctly in the IPDU-Sx as well as in the SNMP software.

This function is particularly useful if you want to control the state of the Output Relays (page 16) through SNMP. With the IPDU-Sx and SNMP network management software properly configured for SNMP control (enable agent, enable traps, apply Read-only and Read-write Community Names), a SET command can be sent either from the SNMP software or MIB browser (Windows) or through command line (Linux) to change the outputRelay value state. See images on page 37 for example of setup.

IP Alias 1 Settings	
Mode	Disable <input type="button" value="v"/> <small>IP alias 1 Mode settings</small>
IP Address	192.168.1.104 <small>Statically assigned IP alias 1 address</small>
Subnet Mask	255.255.255.0 <small>Statically assigned alias 1 subnet mask</small>
Gateway	192.168.1.1 <small>Statically assigned alias 1 gateway</small>
IP Alias 2 Settings	
Mode	Disable <input type="button" value="v"/> <small>IP alias 2 Mode settings</small>
IP Address	98.17.207.215 <small>Statically assigned IP alias 2 address</small>
Subnet Mask	255.255.255.224 <small>Statically assigned alias 2 subnet mask</small>
Gateway	98.17.207.193 <small>Statically assigned alias 2 gateway</small>
IP Alias 3 Settings	
Mode	Disable <input type="button" value="v"/> <small>IP alias 3 Mode settings</small>
IP Address	10.0.5.51 <small>Statically assigned IP alias 3 address</small>
Subnet Mask	255.255.255.0 <small>Statically assigned alias 3 subnet mask</small>
Gateway	10.0.5.1 <small>Statically assigned alias 3 gateway</small>

Figure 38- IP Aliases

IP Aliases

Only applicable to IPDU-S4/S8- Firmware version 1.4 or later

Up to 3 IP aliases can be configured. This provides added flexibility when access from multiple networks is required. To use an alias, be sure to change the default Mode to “Enable”. Then enter a valid IP address, Subnet Mask and Gateway for the network that will have access to the ENVIROMUX.

Only the primary IP Settings can be assigned by a DHCP server and only the primary settings can have DNS Server settings. Only the primary IP settings are used for any outgoing connections like alert emails, syslog etc.

1. Configure the IPDU (Network Settings)

2. Configure the MIB browser

Note: enter same values from IPDU to the MIB browser

3. Expand the tree to view the relay output values (right click -> Get Subtree)

4. Identify which Output to change state (power On or power Off), right click and choose Set

5. Change "Value" to 1 (for On) or 0 (for Off). Click "OK".

6. Confirmation of state change.

SNMP Settings

Enable SNMP Agent: SNMPv1/v2c/v3
 Enable SNMP Traps:
 Read-write community name: private
 Read-only community name: public

Options - MIB Files

IP Address	Port	Version	Read Community	Write Community	User
192.168.3.100	161	1	***** (public)	***** (private)	MD5

iReasoning MIB Browser

Address: 98.17.207.204 | OID: .1.3.6.1.4.1.3699.1.1.6.1.7.1.1.5.1 | Operations: Get Next

Name/OID	Value	Type	IP:Port
ryOutputValue.1	on (1)	Integer	98.17.207.2...
ryOutputValue.2	on (1)	Integer	98.17.207.2...
ryOutputValue.3	on (1)	Integer	98.17.207.2...
ryOutputValue.4	on (1)	Integer	98.17.207.2...
ryOutputValue.5	on (1)	Integer	98.17.207.2...
ryOutputValue.6	on (1)	Integer	98.17.207.2...
ryOutputValue.7	off (0)	Integer	98.17.207.2...
ryOutputValue.8	off (0)	Integer	98.17.207.2...

SNMP SET

OID: .1.3.6.1.4.1.3699.1.1.6.1.7.1.1.5.1
 Data Type: Integer
 Value: 0

SET succeeded

Figure 39- Setup SNMP to control output relays

Cascade Configuration

The Cascade Configuration page is used (IPDU-S4 and IPDU-S8 only) to control multiple IPDU-Sx units, connecting them to one another to form a much larger system that can be administered and monitored from one central point. Units can be cascade using either RS485 or Ethernet connection. When using the RS485 Connection method for cascading the IPDU-Sx will be connected as shown on page 8. If units will be controlled using the Ethernet Connection method, the IPDU-Sx will be connected to a network using the “ETHERNET” port.

In a cascaded configuration, one unit will be the “master” to which each unit is connected as a “slave”. Up to 16 slave units can be connected for a total system configuration of 136 controlled outlets.

If an IPDU-S4 or IPDU-S8 is going to be added to a cascaded system as a slave unit, then the only configuration settings that need to be applied to the slave unit before it can be enabled in the master unit include:

- Enterprise Name (on the Enterprise Configuration page (page 32))
- IP Settings (on the Network Configuration page (page 33) and only if the unit is an Ethernet slave)
- Cascade Configuration for RS485 slave or Ethernet Slave (page 39)

Configure the Type

On the Cascade Configuration page the first setting to configure is the type. Types include:

Type	Description
Master with No Slaves	Stand alone unit, not cascaded, no settings needed
RS485 Slave	Unit will be connected to a master using the “Cascade” ports
Ethernet Slave	Unit will be connected to a master using the Ethernet
RS485 Master	Unit will be the master in a RS485 connected configuration
Ethernet Master	Unit will be the master using the Ethernet

System Configuration

The screenshot shows a web interface for Cascade Configuration. At the top, there is a section titled "Cascade Settings" with a minus sign icon. Below this, the text "This unit is" is followed by a dropdown menu currently showing "Master with no slaves". Below the dropdown is the instruction "Select cascade configuration type". Further down, there is a section titled "Cascade Notification Settings" with a plus sign icon. At the bottom left of the form is a "Save" button.

Figure 40- Cascading- Set the configuration type

RS485 Slave

If the type is **RS485 Slave**, an address number (1-255) must be entered to identify the unit to the master. Each slave on the system must have a unique address number.

System Configuration

Cascade Settings

This unit is
Select cascade configuration type

This units Slave Address
Set the unique rs485 slave address for this unit.

Cascade Notification Settings

Figure 41- Configure as RS485 Slave

Ethernet Slave

If the type is **Ethernet Slave**, the Ethernet address entered on the Network Configuration page (page 33) will be used by the master to communicate with this slave. Each slave on the system must have a unique IP address.

System Configuration

Cascade Settings

This unit is
Select cascade configuration type

Cascade Notification Settings

Figure 42- Configure as Ethernet Slave

RS485 Master

If the type is **RS485 Master**, then the RS485 addresses for each slave (valid address range of 1-255) must be entered into the available blocks (up to 16) in order to communicate between the master and each slave. Once an RS485 address has been entered, and the RS485 slave has been properly configured to be cascaded as part of this system, place a checkmark in the “Enable Slave” block.

System Configuration

- **Cascade Settings**

This unit is RS485 Master ▼
Select cascade configuration type

RS485 Slave1 Address	<input style="width: 95%;" type="text"/>	<input type="checkbox"/> Enable Slave
RS485 Slave2 Address	<input style="width: 95%;" type="text"/>	<input type="checkbox"/> Enable Slave
RS485 Slave3 Address	<input style="width: 95%;" type="text"/>	<input type="checkbox"/> Enable Slave
RS485 Slave4 Address	<input style="width: 95%;" type="text"/>	<input type="checkbox"/> Enable Slave
RS485 Slave5 Address	<input style="width: 95%;" type="text"/>	<input type="checkbox"/> Enable Slave
RS485 Slave6 Address	<input style="width: 95%;" type="text"/>	<input type="checkbox"/> Enable Slave
RS485 Slave7 Address	<input style="width: 95%;" type="text"/>	<input type="checkbox"/> Enable Slave
RS485 Slave8 Address	<input style="width: 95%;" type="text"/>	<input type="checkbox"/> Enable Slave
RS485 Slave9 Address	<input style="width: 95%;" type="text"/>	<input type="checkbox"/> Enable Slave
RS485 Slave10 Address	<input style="width: 95%;" type="text"/>	<input type="checkbox"/> Enable Slave
RS485 Slave11 Address	<input style="width: 95%;" type="text"/>	<input type="checkbox"/> Enable Slave
RS485 Slave12 Address	<input style="width: 95%;" type="text"/>	<input type="checkbox"/> Enable Slave
RS485 Slave13 Address	<input style="width: 95%;" type="text"/>	<input type="checkbox"/> Enable Slave
RS485 Slave14 Address	<input style="width: 95%;" type="text"/>	<input type="checkbox"/> Enable Slave
RS485 Slave15 Address	<input style="width: 95%;" type="text"/>	<input type="checkbox"/> Enable Slave
RS485 Slave16 Address	<input style="width: 95%;" type="text"/>	<input type="checkbox"/> Enable Slave

+ **Cascade Notification Settings**

Figure 43- Configure as RS485 Master

Ethernet Master

If the type is **Ethernet Master**, then the Slave IP Address Settings must be entered for each slave that will be controlled. The IP address will be used by the master to locate and communicate with the slave. Once an IP address has been entered, and the Ethernet slave has been properly configured to be cascaded as part of this system, place a checkmark in the “Enable Slave” block.

System Configuration

Cascade Settings

This unit is Ethernet Master
Select cascade configuration type

Ethernet Slave1 Address	<input style="width: 95%;" type="text" value="192.168.3.99"/>	<input checked="" type="checkbox"/> Enable Slave
Ethernet Slave2 Address	<input style="width: 95%;" type="text" value="192.168.3.98"/>	<input checked="" type="checkbox"/> Enable Slave
Ethernet Slave3 Address	<input style="width: 95%;" type="text"/>	<input type="checkbox"/> Enable Slave
Ethernet Slave4 Address	<input style="width: 95%;" type="text"/>	<input type="checkbox"/> Enable Slave
Ethernet Slave5 Address	<input style="width: 95%;" type="text"/>	<input type="checkbox"/> Enable Slave
Ethernet Slave6 Address	<input style="width: 95%;" type="text"/>	<input type="checkbox"/> Enable Slave
Ethernet Slave7 Address	<input style="width: 95%;" type="text"/>	<input type="checkbox"/> Enable Slave
Ethernet Slave8 Address	<input style="width: 95%;" type="text"/>	<input type="checkbox"/> Enable Slave
Ethernet Slave9 Address	<input style="width: 95%;" type="text"/>	<input type="checkbox"/> Enable Slave
Ethernet Slave10 Address	<input style="width: 95%;" type="text"/>	<input type="checkbox"/> Enable Slave
Ethernet Slave11 Address	<input style="width: 95%;" type="text"/>	<input type="checkbox"/> Enable Slave
Ethernet Slave12 Address	<input style="width: 95%;" type="text"/>	<input type="checkbox"/> Enable Slave
Ethernet Slave13 Address	<input style="width: 95%;" type="text"/>	<input type="checkbox"/> Enable Slave
Ethernet Slave14 Address	<input style="width: 95%;" type="text"/>	<input type="checkbox"/> Enable Slave
Ethernet Slave15 Address	<input style="width: 95%;" type="text"/>	<input type="checkbox"/> Enable Slave
Ethernet Slave16 Address	<input style="width: 95%;" type="text"/>	<input type="checkbox"/> Enable Slave

Cascade Notification Settings

Notify Time 10 Sec
Time after which Slave Not respoding Alert to be sent

Save

Figure 44- Configure as Ethernet Master

Cascade Notification

In the event a slave goes offline from the system, the system can be set to notify those configured to receive messages from the master unit. In the Cascade menu under Administration, the "Cascade Notification Settings" menu provides a place to configure how frequent notifications will be repeated. Cascade Notification cannot be disabled.

System Configuration

The screenshot shows a web interface for 'System Configuration'. Under the 'Cascade Settings' section, there is a sub-section for 'Cascade Notification Settings'. It features a 'Notify Time' field with a text input containing '10' and a dropdown menu set to 'Sec'. Below the input is a tooltip: 'Time after which Slave Not respoding Alert to be sent'. A 'Save' button is located at the bottom left of the configuration area.

Figure 45- Cascade Notification Settings

An example of the notification you will receive is:

```
11-12-2010 11:18:38 AM    Sensor Not Responding    --    Slave Unit #2 (Unit Name) not
responding
```

Suggestion: To avoid receiving unnecessary notifications, don't enable the slave (Figure 43 and Figure 44) when configuring the master until the slave has been fully configured first.

The default time period in which notifications will repeat is every 30 seconds.

The number value range for the time period is 1-99, and the units can be seconds (Sec), minutes (Min), or hours (Hr).

User Configuration

The Users page is a list of all configured users of the IPDU-Sx. A maximum of 15 users (other than root) can be configured. From this page the user can choose to add more users, go to the user configuration page to edit a user's access to the IPDU-Sx, or delete a user from the list. To view the Users page, click on **Users** from the **Administration** section of the menu.

Users

Users					
Num.	Username	Enabled	Admin	Last Login	Action
1	root	yes	yes	09-06-2009 11:58:56 PM	Edit
2	user1	no	no	Never	Edit Delete

[Add New User](#)

Figure 46- Users page

To add a user, click on the “Add New User” link.

To edit a user's configuration, either click on the listed username, or on the “Edit” link.

To delete a user and their configuration, click on “Delete” link.

When adding a new user, the Configure User page will open with the username “userx” assigned, where x = the next consecutive number (up to 15) based on the quantity of users in the list (other than the root user). You can either leave the name as “userx”, or change it to what you would like to see listed. With the name assigned, fill in the remaining information as needed.

Configure User

[-] Account Settings

Username	<input type="text" value="Bill"/> <small>The username for this user</small>
Admin	<input type="checkbox"/> <small>Grant this user administrative privileges</small>
Enabled	<input checked="" type="checkbox"/> <small>Users can only access the system if their account is enabled</small>
Password	<input type="password" value="••••••"/> <small>The user's password to login to the system (for local authentication)</small>
Confirm	<input type="password" value="••••••"/> <small>Confirm the entered password</small>
Title	<input type="text"/> <small>The user's title within the company</small>
Department	<input type="text"/> <small>The user's department within the company</small>
Company	<input type="text"/> <small>The name of the user's company</small>

[+] LDAP Account Settings

[+] Contact Settings

[+] Schedule Settings

Figure 47- Configure Users page

▢ **LDAP Account Settings**

Common Name (for LDAP)
The Common Name for the user in an Active Directory

Organizational Unit (for LDAP)
The Organizational Unit the user belongs to in an Active Directory

▢ **Contact Settings**

Group 1
User receives notifications for Group 1

Group 2
User receives notifications for Group 2

E-mail Alerts
User receives alerts via e-mail

E-mail Address
E-mail address for the user

Syslog Alerts
User receives alerts via syslog

SNMP Traps
User receives alerts via SNMP traps

Syslog/SNMP IP Address
IP address where syslog messages/SNMP traps are sent for this user

SMS Alert ← IPDU-S4/S8 only
User receives alerts sms

Phone Number
User phone number for alert and notification

▢ **Schedule Settings**

Schedule Type
Configure the user's schedule type

Start Day
First day of the week when the user active

End Day
Last day of the week when the user active

Start Hour
Starting hour for the user's daily schedule

End Hour
Ending hour for the user's daily schedule

Figure 48- Configure User- more options

Account Settings	Description
Username	Enter the desired username for this user
Admin	Place a checkmark here if this user should have administrative privileges
Enabled	Place a checkmark here to enable this user to access the IPDU-Sx
Password	Enter a password that a user must use to login to the system A password must be assigned for the user's login to be valid Passwords must be at least 1 keyboard character.
Confirm	Re-enter a password that a user must use to login to the system
Title	Enter information as applicable
Department	Enter information as applicable
Company	Enter information as applicable

LDAP Account Settings	
Common Name (for LDAP)	“Common Name” assigned in the LDAP server account in an Active Directory. Often a name assigned that is different than the Username. If this is the same as the Username in the “Account Settings” (above), this can be left blank.
Organizational Unit (for LDAP)	Enter the Organizational Unit the user belongs to in an Active Directory Format is <ou,ou,etc> (like example in Figure 48)
Contact Settings	
Group 1	Place a checkmark if the user should receive messages from sensors, IP devices and outlets in Group 1 (see also pages 24 and 26 for group assignments)
Group 2	Place a checkmark if the user should receive messages from sensors, IP devices and outlets in Group 2 (see also pages 24 and 26 for group assignments)
Email alerts	Place a checkmark if the user should receive messages via email
Email address	Enter a valid email address if this user should receive email alert messages
Syslog alerts	Place a checkmark if the user should receive alerts via syslog messages
SNMP traps	Place a checkmark if the user should receive alerts via SNMP traps
Syslog/SNMP IP address	Enter a valid syslog/SNMP IP address for the user to receive syslog/SNMP messages
SMS Alert	Place a checkmark if the user should receive alerts via SMS messages (IPDUS4/S8 only)
Phone Number	Enter a phone number for the GSM modem to call to alert the user via SMS message
Schedule Settings	
Schedule Type	Always active - user will receive messages at all hours of each day Active during defined times - user will only receive alert messages during times as outlined below
Start Day	First day of the week the user should begin receiving messages
End Day	Last day of the week the user should receive messages Note: Start Day and End Day must be different, or no messages will be sent.
Start Hour	First hour of the day the user should begin receiving messages
End Hour	Last hour of the day the user should receive messages

More about User Privileges

The root user (or any user with administrator rights) can change the root password and configure how the root user will receive alert messages. Users with administrative rights can change all configuration settings except for the root user name.

Users with user rights can only see the current readings of monitored items and change their own passwords.

Summary

Power Outlets					
Num.	Description	Type	Mode	Status	Action
1	Power Outlet 1	Power Outlet	Manual	On	View Turn Off Cycle
2	Power Outlet 2	Power Outlet	Manual	On	View Turn Off Cycle

Sensors					
Conn.	Description	Type	Value	Status	Action
1	Undefined #1	Temperature Combo	29.4C	Normal	View
1	Undefined #1	Humidity Combo	31.5%	Normal	View

IP Devices					
Num.	Description	Type	Value	Status	Action
1	ENVIROMUX-MINI-no.1	IP Device	Responding	Normal	View
2	ENVIROMUX-MINI-no.2	IP Device	Responding	Normal	View

Figure 49-Summary page for User without Admin privileges

Security

Access to the web interface on the IPDU can be through standard methods (enable HTTP access- page 35) or limited to secure access only (disable HTTP access and only allow HTTPS access which is always enabled by default). Security in the IPDU-Sx can be managed one of two ways; through the local settings (passwords assigned in user settings on page 44) or through an LDAP server. If security is configured to use LDAP mode, then the passwords for users must be those found on a configured LDAP server. To view the Security Configuration page, select **Security** in the **Administration** section of the menu.

Figure 50- Security Configuration page

When in LDAP mode, usernames on the LDAP server must match those in the user settings of the IPDU-Sx or access will be denied.

Note: When in LDAP mode, if the LDAP server is not responding, local authentication will be tried.

User Authentication	
Mode	Select "Local" to use authentication based on passwords in the IPDU-Sx user configuration Select "LDAP" to use authentication based on passwords in an LDAP server Select "Certificate+Login" when authentication requires the connecting PC to hold a valid certificate
LDAP Primary Server	Enter Hostname or IP address of Primary LDAP Server
LDAP Secondary Server	Enter Hostname or IP address of Secondary LDAP Server (optional)
LDAP Server Type	Choose from drop down list: Generic LDAP server Novell Directory server Microsoft Active Directory
LDAP User Base DN	Enter the Base DN for users (ex: ou=People,dc=mycompany,dc=com)

Even though LDAP authentication is being used, each user must also have a local account. User permission level is established by the local account.

X509 Certificate

The IPDU-Sx is pre-loaded with a generic X509 Server Certificate. If you wish to provide your own X509 Server certificate, the Server certificate must be uploaded to the ENVIROMUX. The Server certificate and key must be combined in a single file ("PEM" format). For instruction to create your own certificate, see page 111.

Browse to the Server certificate file and select it. Then load using the button **"Upload Server Certificate and key"**.

Note: The key used should not be password protected.

X509 Client Authentication

In addition to Local and LDAP client authentication, X509 client authentication is also available. In order to use X509 client certificate authentication, select **"Certificate + Login"** for the mode setting (Figure 50). X509 client certificate authentication requires the user to present client certification (this happens behind the scenes when you enter the https IP address, before you are presented with a "Login" screen). For this to work:

1. A client certificate signed by a Certifying Authority (CA) must be loaded into the user's browser.
2. Use **"Choose File"** and browse to the CA certificate (file with ".crt" extension) and select it.
3. Click on the **"Upload CA certificate"** button and load the CA certificate to the ENVIROMUX.

Note: The user will need to login after the X509 client certificate is validated.

The **"Restore default certificate"** button will restore the unit's default self-signed certificates if needed.

Whether you are just loading your own Server Certificate, or also using client authentication, **reboot the IPDU-Sx for this certificate to take effect.**

Security Configuration

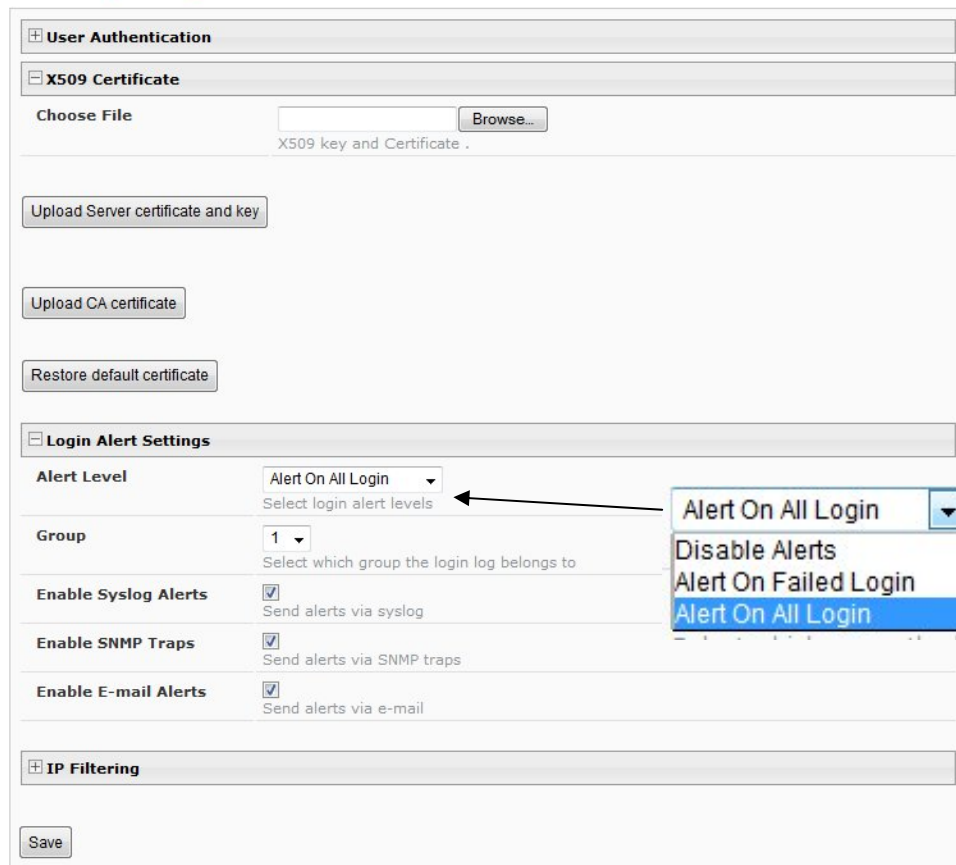

Figure 51- Security Configuration-X509 Certificate and Login Alerts

Note: HTTP access can be enabled/disabled from web page under Administration -> Network -> Server Settings -> Enable HTTP (page 35). Do not disable http access until you verify certificate verification works properly for https connection. HTTP connection will allow you to change any settings if a wrong certificate is uploaded. Once HTTPS client certificate validation is verified to be working properly, disable HTTP access for security.

Login Alert Settings

The IPDU-Sx can be configured to send an alert to users in either group 1 or group 2 when a user logs in or when someone attempts to login but fails to enter a correct password. To disable this feature, just select "Disable Alerts".

Once selected, be sure to select whether the alerts should be sent via Syslog, SNMP, and/or E-mail.

Be sure to press **Save** after changes are made.

IP Filtering

Included in the Security Configuration options is IP Filtering. IP Filtering provides an additional mechanism for securing the IPDU-Sx. Access to the IPDU-Sx network services (SNMP, HTTP(S), SSH, Telnet) can be controlled by allowing or disallowing connections from various IP addresses, subnets, or networks.

Up to 16 IP Filtering rules can be defined to protect the IPDU-Sx from unwanted access from intruders. Each rule can be set as Enabled or Disabled. Rules can be set to explicitly drop attempts to connect, or to accept them.

Be sure to press **Save** after changes are made.

☰ **IP Filtering**

Num.	Enabled	Mode	Filter Rule
1	Disabled ▾	DROP ▾	192.168.1.0/24
2	Disabled ▾	DROP ▾	192.168.1.0/24
3	Disabled ▾	DROP ▾	192.168.1.0/24
4	Disabled ▾	DROP ▾	192.168.1.0/24
5	Disabled ▾	DROP ▾	192.168.1.0/24
6	Disabled ▾	DROP ▾	192.168.1.0/24
7	Disabled ▾	DROP ▾	192.168.1.0/24
8	Disabled ▾	DROP ▾	192.168.1.0/24
9	Disabled ▾	DROP ▾	192.168.1.0/24
10	Disabled ▾	DROP ▾	192.168.1.0/24
11	Disabled ▾	DROP ▾	192.168.1.0/24
12	Disabled ▾	DROP ▾	192.168.1.0/24
13	Disabled ▾	DROP ▾	192.168.1.0/24
14	Disabled ▾	DROP ▾	192.168.1.0/24
15	Disabled ▾	DROP ▾	192.168.1.0/24
16	Disabled ▾	DROP ▾	192.168.1.0/24

DROP
ACCEPT

Figure 52- Security Configuration- IP Filtering Rules

More on IP Filtering

The most common approach is to only allow “whitelisted” IP addresses, subnets, or networks to access the device while blocking all others. The IP Filters are processed sequentially from top to bottom, so it is important to place the most precise rules at the top of the list and the most generic rules at the bottom of the list.

As an example, assume we wish to block all connections except those which come from the IP address 192.168.1.100. To allow connections from 192.168.1.100, we need to configure and enable an ACCEPT rule at the top of the list:

1 Enabled ACCEPT

Then, to block all other IP addresses from connecting to the IPDU-Sx, we add a rule to drop all other connections.

16 Enabled DROP

If the preceding “drop all connections” rule was placed in position one, no connections at all would be allowed to the unit. Remember: rules are processed from top to bottom. As soon as a rule matches, the processing stops and the matching rule is executed.

To match a particular IP address, simply enter in the desired IP address (e.g. 192.168.1.100).

To match a subnet, enter in the subnet with the associated mask (e.g. 192.168.1.0/24).

To match all IP address, specify a mask of 0 (e.g. 0.0.0.0/0).

System Information

The system information page displays the model name of the IPDU-Sx, the firmware version in the IPDU-Sx, the MAC address of the Ethernet port, the IP mode, and the network configuration. To view the System Information, select **System Information** in the **Administration** section of the main menu.

System Information

System Information	
Product:	IPDU-S2 Secure Power Reboot Switch
Revision:	1.0
Code Date:	10-01-2009 03:00:53 PM
MAC Address:	00:0C:82:05:00:04
IP Mode:	DHCP
IP Address:	192.168.3.119
Subnet Mask:	255.255.255.0
Default Gateway:	192.168.3.3
Primary DNS:	166.102.165.11
Secondary DNS:	

Figure 53- System Information page

Update Firmware

The Update Firmware page is used to change the firmware of the IPDU-Sx. Occasionally new features or changes to existing features will be introduced and new firmware with these changes will be made available on the NTI website (<http://www.networktechinc.com/download/d-secure-power.html>). To view the Update Firmware page, select **Firmware** in the **Administration** section of the main menu. Once a user has downloaded the required file for firmware upgrade, this page will be used to upload it to the IPDU-Sx.

Update Firmware

Firmware Update

Caution! You have asked to update the firmware. Failure to update firmware properly can permanently damage the product.

Update file

Choose the firmware update file.
Current firmware version is 1.0.

Figure 54- Update Firmware page

1. Download the most current firmware file from <http://www.networktechinc.com/download/d-secure-power.html> to a location on your PC.
2. Click on the "Browse" button and locate and select the firmware file for the IPDU-Sx (*webupdate-ipdu-sx-vx-x.bin, for example*).
3. Click on the "Update" button to perform the firmware update. The firmware update process will take approximately 5 minutes while the IPDU-Sx installs the firmware. Once the update file has been installed, the unit will automatically reboot and the login screen will appear.

Reboot the System

The IPDU-Sx can be remotely rebooted by anyone with administrative privileges. To view the Reboot System page, select **Reboot** in the **Administration** section of the main menu. Click the **Reboot Now** button to cause the IPDU-Sx to reboot. This will disconnect any user and shut down all activity.

Reboot System



Figure 55- Reboot System page

The message "System is rebooting, please wait...." will appear and after approximately 45 seconds the login screen will appear. Log in to resume activity.

System Reboot

System is rebooting, please wait...

Figure 56- System is rebooting

Log

From the Log section there are three sub sections for configuring the IPDU-SX:

Monitoring	View Event Log	View a log listing the date and time of events such as startups, shut downs, outlet power cycling, user logins
Administration	View Data Log	View data readings from sensors and IP addresses
Log	Log Settings	Configure how the logs handle reaching capacity, which users will be notified that it has reached capacity, and how they will be notified
View Event Log		
View Data Log		
Log Settings		
Support		
Logout		

View Event Log

The Event Log provides the administrative user with a listing of many events that occur within the IPDU-Sx. The event log will record the date and time of:

- each IPDU startup,
- each power outlet cycling,
- each user login and logout time,
- any time an unknown user tries to login,
- sensor and IP device alerts
- an alert handled by a user

Event log

Jump to page: Entries per page:

Showing Entries 1-4 of 4 Event Log Free Space: 99.6%

Select	Date/Time	Type	Value	Message
<input type="checkbox"/>	09-08-2009 12:14:04 AM	Start-up	--	System start-up
<input type="checkbox"/>	09-08-2009 12:14:05 AM	Power Outlet changed	On	Outlet: "Power Outlet 1" : Turned on by system boot
<input type="checkbox"/>	09-08-2009 12:14:05 AM	Power Outlet changed	On	Outlet: "Power Outlet 2" : Turned on by system boot
<input type="checkbox"/>	09-08-2009 12:21:30 AM	Login	--	User root logged in via web interface

[Previous](#) [Next](#)

Figure 57- Event Log page

From the Event Log page the administrative user can view the logs, select specific logs to be deleted or press **Clear Log** to delete them all. The number of entries per page can be changed for the user's reading preference. Navigating between pages is as easy as clicking **Previous** or **Next** buttons, or jumping to a specific page if you know where the log entry you are interested in is listed.

To clear only specific log entries, place a checkmark in each line item to be deleted, and press **Delete Selected**. Before deleting, the user may want to save the log for future reference and to make space for more logs by downloading the event log to a file on a PC. Press **Download Event Log** to save the log file before clearing it.

View Data Log

The Data Log provides the administrative user with a listing of all the readings taken by the IPDU-Sx pertaining to the sensors and IP Devices being monitored. The event log will record the date and time of each reading.

Data log

Jump to page: Entries per page:

Showing Entries 1-4 of 4 Data Log Free Space: 99.6%

Select	Date/Time	Type	Value	Description
<input type="checkbox"/>	09-08-2009 12:41:13 AM	Temperature Combo	29.2C	Undefined #1
<input type="checkbox"/>	09-08-2009 12:41:30 AM	Humidity Combo	30.6%	Undefined #1
<input type="checkbox"/>	09-08-2009 12:41:54 AM	IP Device	Responding	ENVIROMUX-MINI-no.1
<input type="checkbox"/>	09-08-2009 12:42:13 AM	IP Device	Responding	ENVIROMUX-MINI-no.2

Previous Next

Figure 58- Data Log page

From the Data Log page the administrative user can view the logs, select specific logs to be deleted or press **Clear Log** to delete them all. The number of entries per page can be changed for the user's reading preference. Navigating between pages is as easy as clicking **Previous** or **Next** buttons, or jumping to a specific page if you know where the log entry you are interested in is listed.

To clear only specific log entries, place a checkmark in each line item to be deleted, and press **Delete Selected**. Before deleting, the user may want to save the log for future reference and to make space for more logs by downloading the event log to a file on a PC. Press **Download Data Log** to save the log file before clearing it.

Log Settings

The Log Settings page (Figure 59) provides settings for how the IPDU-Sx will react when its Data and Event logs reach capacity.

Each log can be assigned to a group and any user that receives messages from that group can be notified when capacity is being reached.

The log can be set to either :

- Discontinue- stop logging information
- Clear and restart- delete all log entries and restart with new entries
- Wrap- continue logging but delete the oldest entries and new ones are recorded

The Data and/or Event log can be set to sent alerts to users via email, syslog, and/or SNMP traps once it has reached 90% of capacity, allowing them time to react.

Log Settings

Event Log Settings	
Group	<input type="text" value="1"/> Select which group the event log belongs to
Overflow Action	<input type="text" value="Discontinue Log"/> Choose the action to take when the event log overflows
Enable Syslog Alerts	<input type="checkbox"/> When event log reaches 90% of capacity, send alerts via syslog
Enable SNMP Traps	<input type="checkbox"/> When event log reaches 90% of capacity, send alerts via SNMP traps
Enable E-mail Alerts	<input type="checkbox"/> When event log reaches 90% of capacity, send alerts via e-mail
Data Log Settings	
Group	<input type="text" value="1"/> Select which group the data log belongs to
Overflow Action	<input type="text" value="Discontinue Log"/> Choose the action to take when the data log overflows
Enable Syslog Alerts	<input type="checkbox"/> When data log reaches 90% of capacity, send alerts via syslog
Enable SNMP Traps	<input type="checkbox"/> When data log reaches 90% of capacity, send alerts via SNMP traps
Enable E-mail Alerts	<input type="checkbox"/> When data log reaches 90% of capacity, send alerts via e-mail

Figure 59- Log Settings page

Record Logs to USB Flash

In the IPDU-S4 / -S8 models, the option to enable or disable the USB port on the IPDU is available. The USB port can be used to connect either a GSM modem for receiving SMS messages (page 8), and/or to make the log file portable by connecting a USB flash drive. The IPDU-S4 or IPDU-S8 will record event and data logs to a USB flash drive in addition to the internal IPDU-Sx memory when the feature is enabled.

Unit: IPDU S8 Test Unit 2 Model: IPDU-Sx
Uptime: 4 hours, 36 mins
Current Time: 10-21-2010 04:24:13 PM

Home > Configure Log

- Monitoring
- Administration
- Log
- View Event Log
- View Data Log
- Log Settings
- Support
- Logout

Log Settings

<input type="checkbox"/> Event Log Settings
<input type="checkbox"/> Data Log Settings
<input type="checkbox"/> Log To Usb Flash Settings
Enable Log to Flash drive <input type="checkbox"/> <small>Enable log to USB flash drive. Disable this before removing the flash drive</small>

Figure 60- Log to USB Flash Settings

To use the USB port, carefully follow the steps below.

1. Insert a USB flash drive to the USB port.
2. Place a checkmark in the “Enable Log to Flash drive” box found on the Log Settings page (Figure 61).

Note: If the flash drive is not connected before enabling the feature, the IPDU-Sx will not recognize the flash drive.

3. The data and event logs will be recorded to both the USB flash drive and the IPDU-S4/ -S8 internal memory.

4. When removing the flash drive- remove the checkmark from the “Enable Log to Flash drive” before removing the flash drive from the USB port. Removing the flash drive before disabling the feature may cause any file(s) on the flash drive to be corrupted.

FYI: The USB port can also be enabled from the Text Menu (page 100).

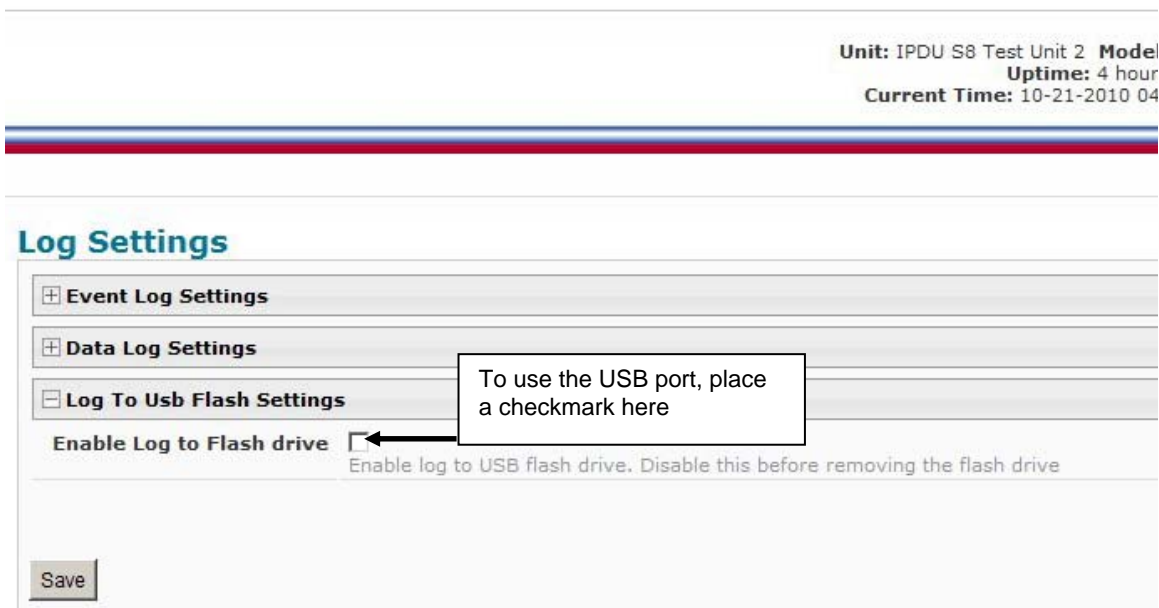

Figure 61- Enable USB Port

Support

The Support section of the menu includes two links, Manual and Downloads.

The Manual link will open the pdf manual for the IPDU-Sx on the NTI website. You must have Adobe Reader installed on your PC to open this.

The Downloads link will take you to the Firmware Downloads page for the IPDU-Sx on the NTI website. All versions of firmware and MIB files for the IPDU-Sx will be found there, available for immediate download to your PC.

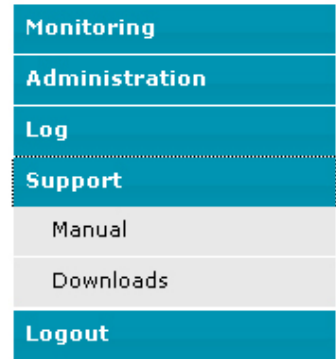

Figure 62- Support

Logout

To logout of the IPDU-Sx user interface, click on the “Logout” section in the menu. A gray menu label will drop down. Click on the gray label to be immediately logged out. The login screen will appear, at which you can close your browser or log back in.

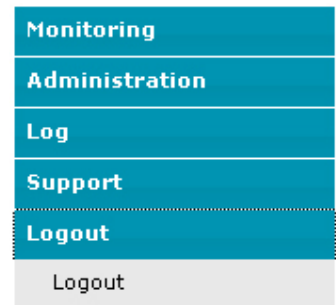

Figure 63- Logout

OPERATION VIA TEXT MENU- IPDU-SX

The IPDU-Sx can be controlled using a terminal program (e.g. HyperTerminal) via an RS232-Link, connected to Console Port (page 6) or using Telnet or SSH protocol via the Ethernet Port. Either of these methods will work to access the IPDU-Sx text menu. The text menu can be used to control all functions of the IPDU-Sx as an alternative to the Web Interface (page 14).

Connection Via Console Port

The following instruction will enable the user to quickly make connections using a terminal connected to the "CONSOLE" port. For instruction to make quick connection using the Ethernet port and Web Interface, see page 14.

1. Make sure the IPDU-Sx is turned OFF.
2. Using the serial console device connected to the port labeled "CONSOLE", start the terminal program (e.g. Windows HyperTerminal) and configure it as follows:
 - direct connection (using the appropriate CPU local serial Com port)
 - 115200 bps
 - 8 bits
 - no parity
 - 1 stop bit
 - no flow control
 - VT100 terminal mode.
3. Power ON the IPDU-Sx. Wait for the IPDU-SX login prompt.
4. At "Username: " type `<root>` (all lowercase letters) and press `<Enter>`.
5. At "Password" type `<nti>` (all lowercase letters) and press `<Enter>`.

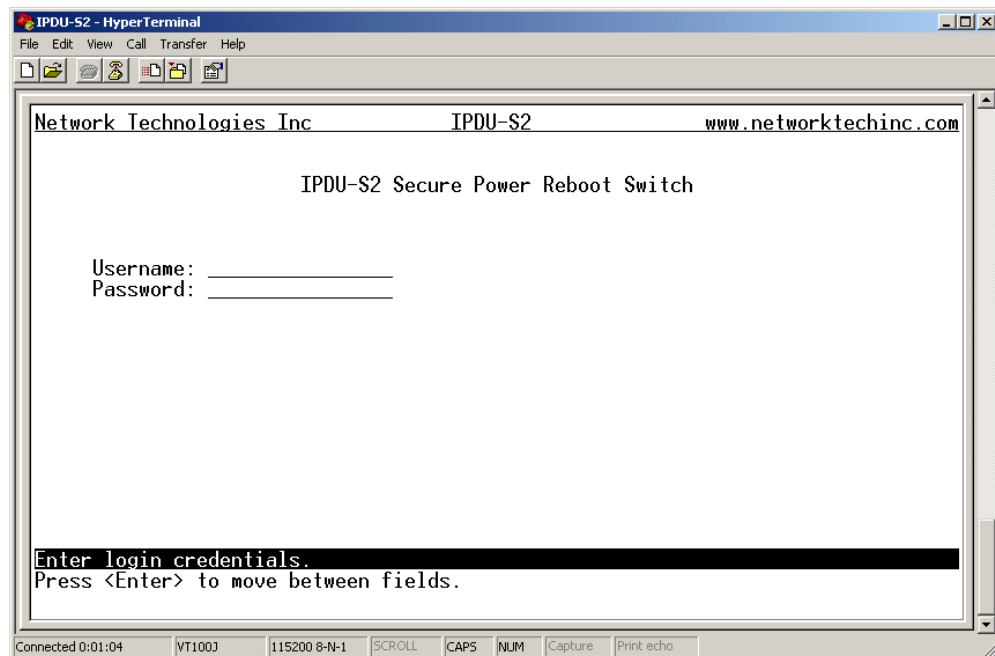

Figure 64- Text Menu Login screen

Note: User names and passwords are case sensitive. It is important to know what characters must be capitalized and what characters must not.

Connect to IPDU-Sx from Command Line

To connect directly to a serial port from the command line, the IPDU-Sx must first be connected to the Ethernet (page 5).

Connect Via Telnet

To open a telnet session to the IPDU-Sx, Issue the following command from the command line:

```
telnet <IPDU-Sx hostname or IP address>
```

<IPDU-Sx hostname> is the hostname configured in the workstation where the telnet client will run (through /etc/hosts or DNS table). It can also be just the IP address of the IPDU-Sx.

The user will be prompted for username and password to connect to the IPDU-Sx.

Connect Via SSH

To open an SSH session to a serial port, issue the following command from the command line:

```
ssh -l <Username> <IPDU-Sx hostname or IP address>
```

<Username> is the user configured to access the IPDU-Sx (as defined in the list of users (page 43).

<IPDU-SX hostname> is the hostname configured in the workstation where the SSH client will run (through /etc/hosts or DNS table). It can also be just the IP address of the IPDU-Sx.

The user will be prompted for a password to connect to the IPDU-Sx.

The main menu of the Text Menu will be displayed whether you are connecting via the Console port, Telnet, or SSH.

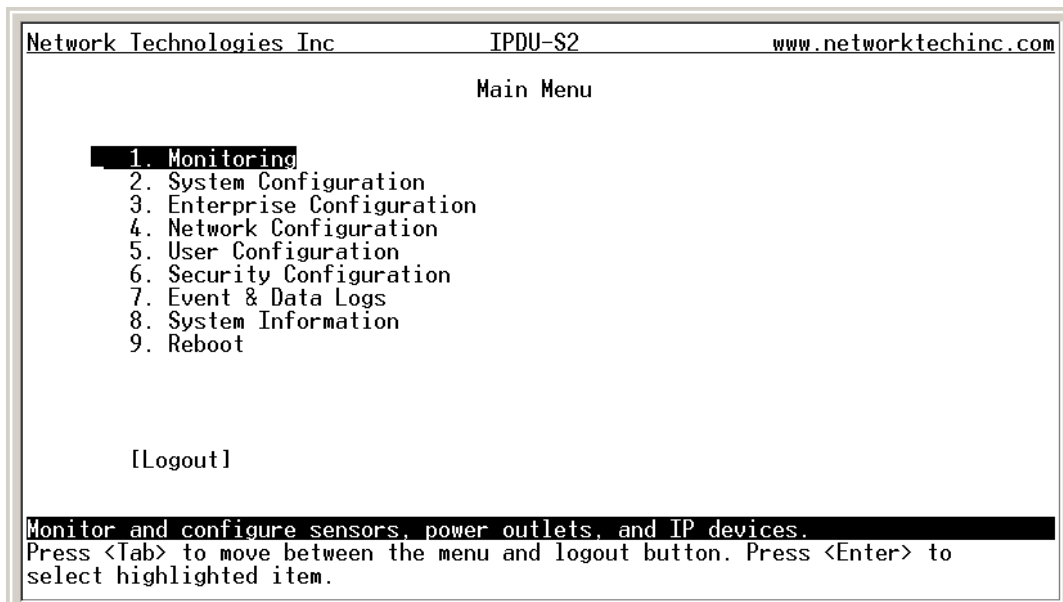

Figure 65- Text Menu- Administrator Main Menu

Then main menu in the IPDU-S4 and IPDU-S8 has an additional category of “Cascade Configuration. For more on Cascading, see page 85.

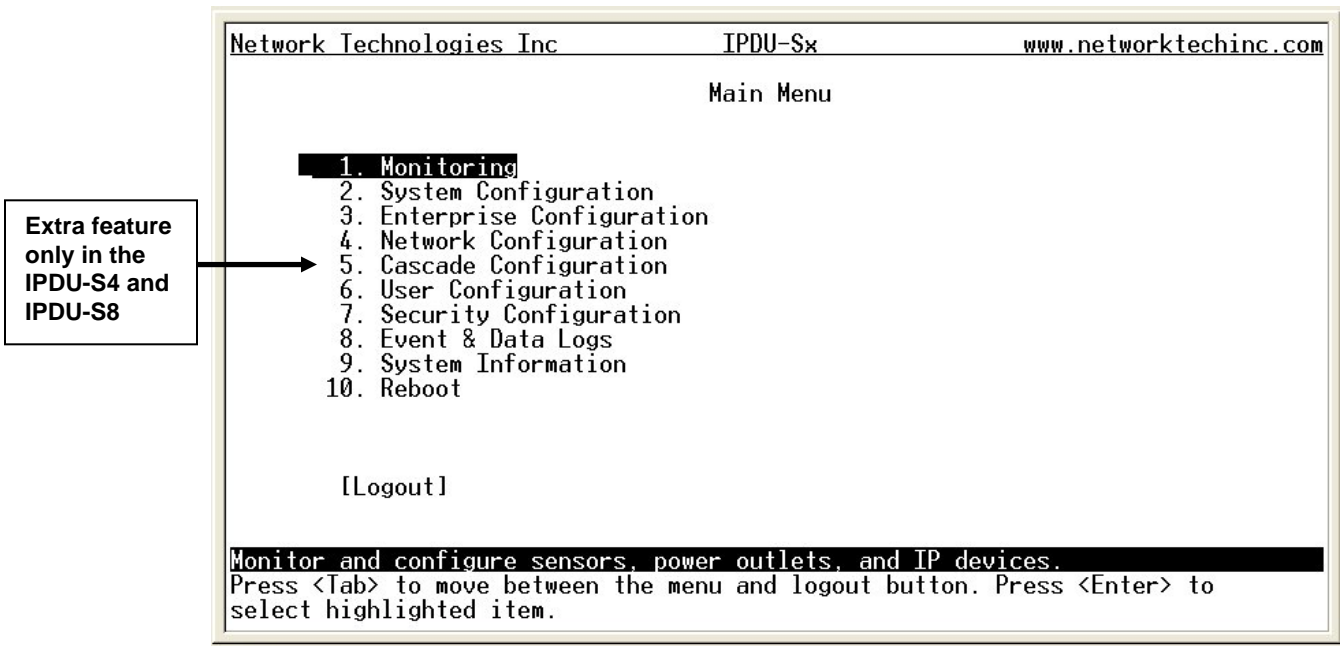

Figure 66- Text Menu- Main Administrator Menu in IPDU-S4/-S8

If you are a user with only user privileges (no administrative privileges), the text menu will have more limited options.

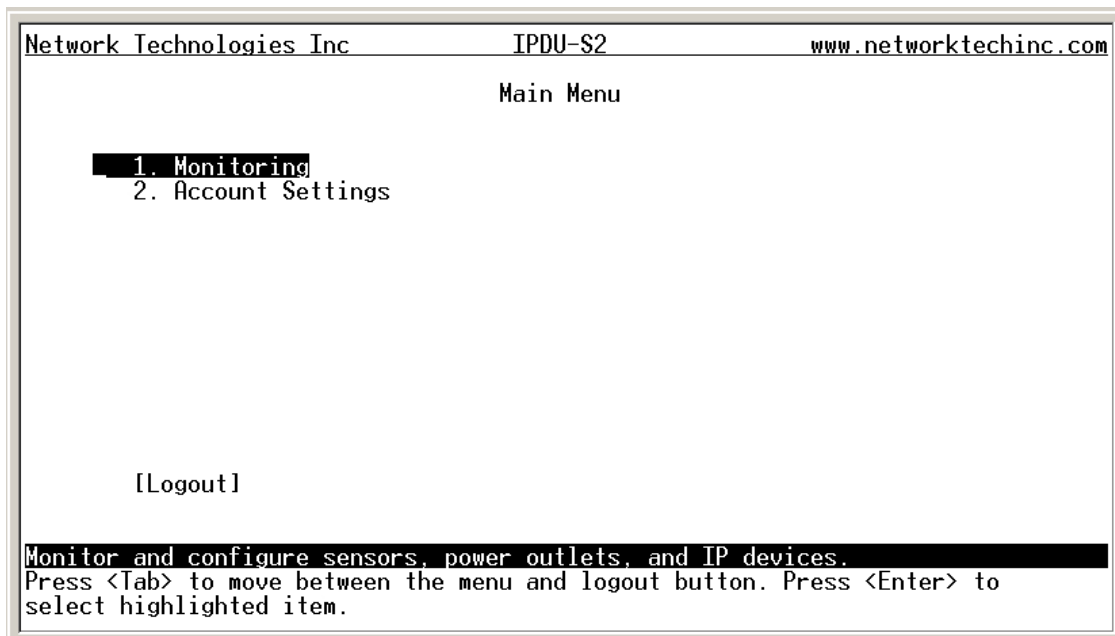

Figure 67- Text Menu- User Main Menu

For more on the Text Menu options for non-administrative users, see page 102.

Using the Text Menu

Text Menu Navigation

- To move up and down the numbered menu items, use the arrow keys.
- To jump from menu item to another quickly, press the numbered key above the QWERTY keys (the numberpad number keys are not used).
- To move from menu list to action key (such as “Logout” in Figure 67 above), press <Tab>.
- To exit an action or menu, press <Esc>.
- To select a highlighted item or move to another field in a configuration page, press <Enter>.
- Be sure to Tab to “Save” and press <Enter> when configuration changes are made.
- To return from “Save” back to a field on the configuration page, press <Tab>.

The Administrators Main Menu is broken into 9 categories:

Function	Description
Monitoring	Monitor and configure the sensors, outlets and IP devices
System Configuration	Set the IPDU-SX time settings or reset the unit to factory default settings
Enterprise Configuration	Configure system settings
Network Configuration	Configure network settings
Cascade Configuration	Configure cascade settings (IPDU-S4 and IPDU-S8 only)
User Configuration	Configure user access settings
Security Configuration	Configure security settings
Event and Data Logs	View and configure the Event and Data Logs (page 97)
System Information	View system and network settings
Reboot	Enables the user to reboot the IPDU-SX

Monitoring

The Monitoring menu lists choices for viewing the status of items monitored by the IPDU-Sx as well as for configuring how they are monitored and how or if alert messages will be sent.

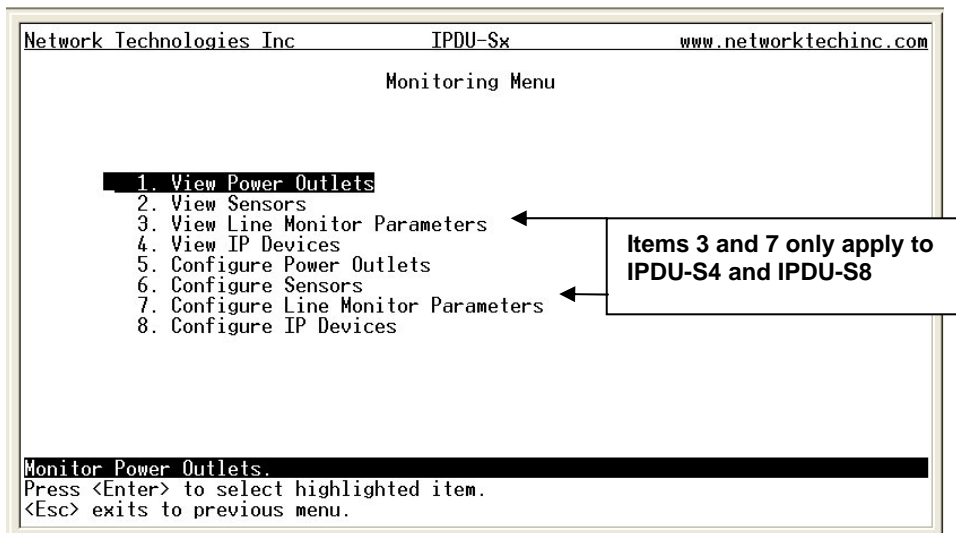

Figure 68- Text Menu-Monitoring Menu

View Power Outlets

The View Power Outlets selection will show the present status of the Power Outlets on the IPDU-Sx. The current operation mode of the outlet is shown, as well as its ON/OFF state. To change its state, select the outlet and press **<Enter>**. Use the **<Tab>** or **<Arrow>** keys to move between Cancel, Turn ON, Turn OFF, or Cycle to power cycle the IPDU-Sx. If Cycle is selected, the IPDU-Sx will power cycle the outlet based on the configuration settings found under Power Outlet Configuration.

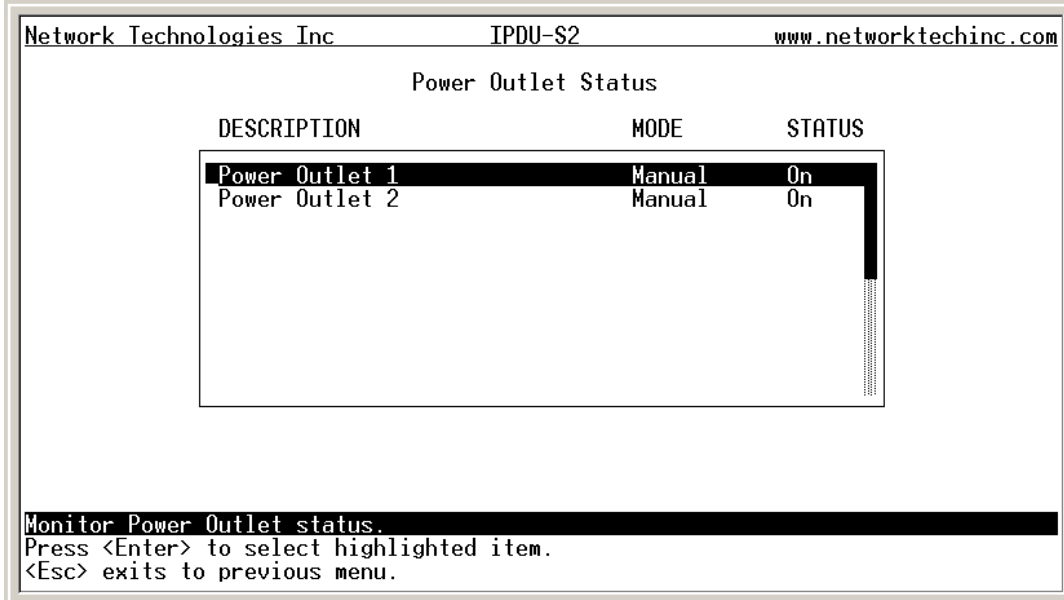

Figure 69- Text Menu-Power Outlet Status

View Sensors

The View Sensors selection will show the present status of each sensor connected to the IPDU-Sx.

The current value being reported by the sensor and the state (whether Normal or Alert) will be shown. If the sensor is in alert status, pressing the **<Enter>** key would provide the option to either **acknowledge** the alert or **dismiss** it.

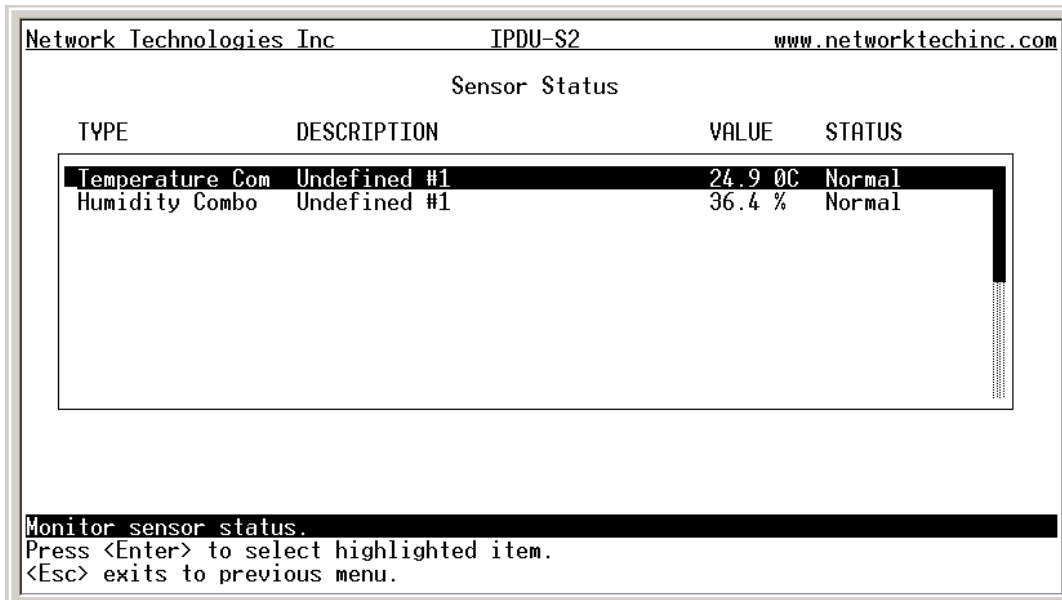

Figure 70- Text Menu-Sensor Status

View Line Monitor Parameters

The View Line Monitor Parameters selection (IPDU-S4 and IPDU-S8 only) will show the present status of each characteristic of the power being provided by the IPDU-Sx to the outlets. In the image below, not only is the power through the master being monitored, but the power through each slave. If the parameter is in alert status, pressing the <Enter> key would provide the option to either **acknowledge** the alert or **dismiss** it.

NO.	TYPE	DESCRIPTION	VALUE	STATUS
1	Voltage	Master Line Voltage	116.5V	Normal
2	Current	Master Outlet Current	0.1 A	Normal
3	Frequency	Master Line Frequency	60.0 Hz	Normal
4	Breaker	Master Circuit Breaker St	Closed	Normal
5	Voltage	Slave 1 Line Voltage	114.2V	Normal
6	Current	Slave 1 Outlet Current	0.0 A	Normal
7	Frequency	Slave 1 Line Frequency	60.0 Hz	Normal
8	Breaker	Slave 1 Circuit Breaker S	Closed	Normal

Monitor sensor status.
Press <Enter> to select highlighted item.
<Esc> exits to previous menu.

Figure 71- Text Menu- Line Monitor Parameters

View IP Devices

The View Sensors selection will show the present status of each IP Device monitored by the IPDU-Sx.

The current value being reported by the IP Device and the state (whether Normal or Alert) will be shown. If the IP Device is in alert status, pressing the <Enter> key would provide the option to either **acknowledge** the alert or **dismiss** it.

DESCRIPTION	VALUE	STATUS
ENVIROMUX-MINI no.1	Responding	Normal
ENVIROMUX-MINI no.2	Responding	Normal

Monitor IP Device status.
Press <Enter> to select highlighted item.
<Esc> exits to previous menu.

Figure 72- Text Menu-View IP Devices

Configure Power Outlets

The Configure Power Outlets menu lists the power outlets in the IPDU-Sx. Press <Enter> to open the configuration menu for the selected Power Outlet.

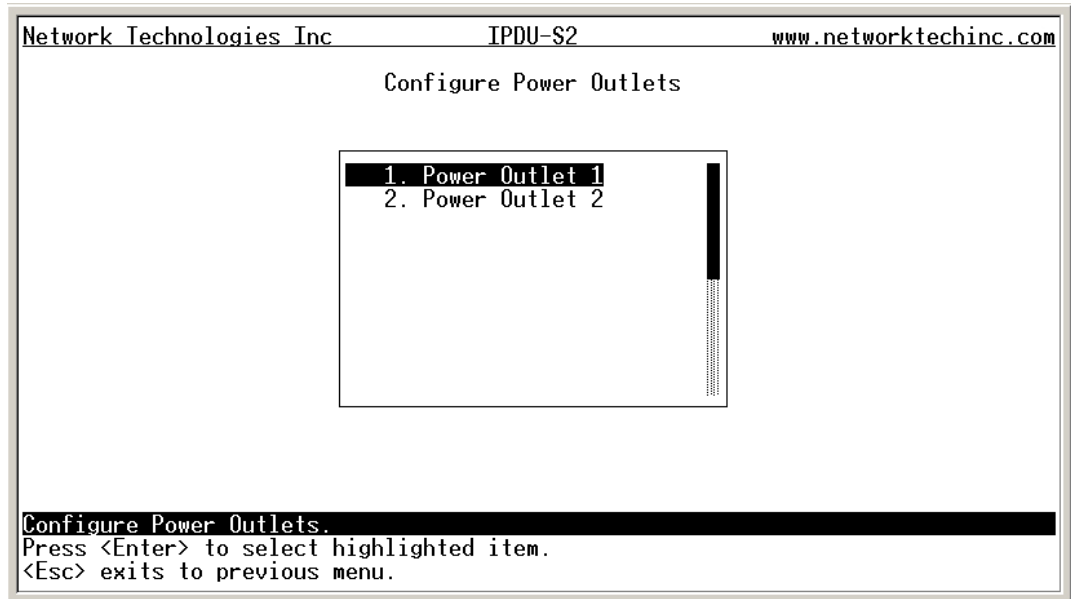

Figure 73- Text Menu-Configure Power Outlets

The configuration menu for the Power Outlet includes options to enter the Power Outlet Settings, Notification Settings, and Outlet Operation Settings.

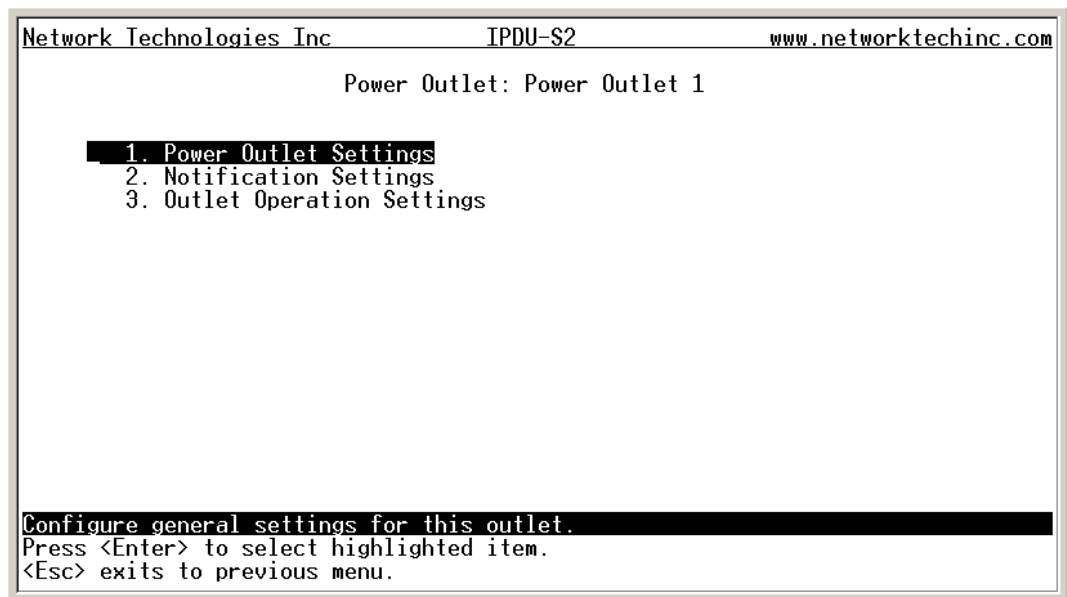

Figure 74- Text Menu-Power Outlet menu

Power Outlet Settings

From the Power Outlet Settings menu enter the Description for the outlet and select which sensor group the outlet should belong to (1 or 2).

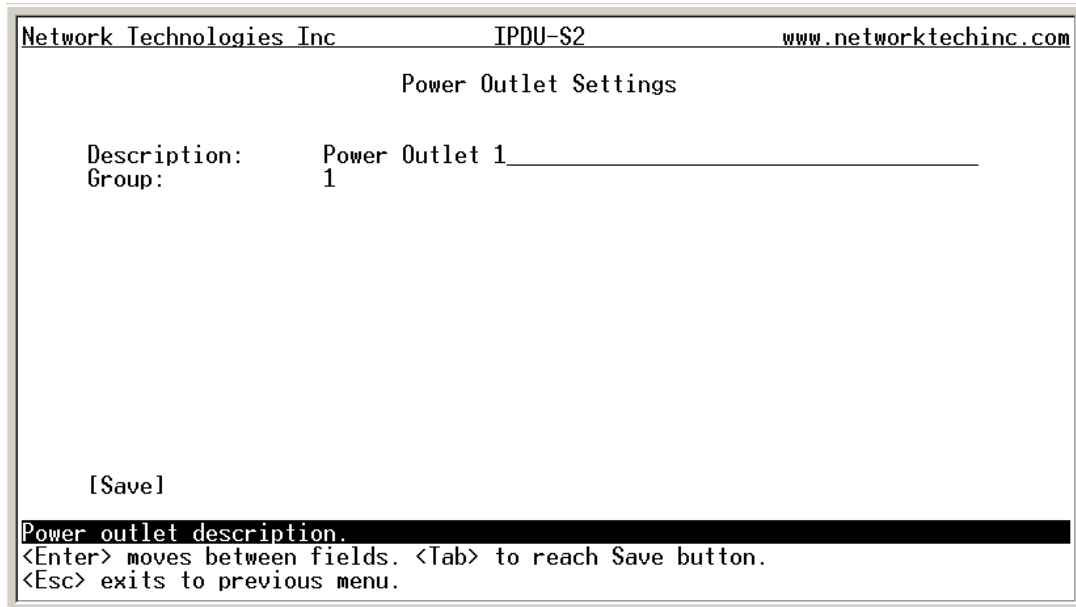

Figure 75- Text Menu-Power Outlet Settings

Power Outlet Notification Settings

From the Notification Settings menu, the user can enable/disable alert messages to be sent when the power outlet state changes and configure if and how alert messages are sent.

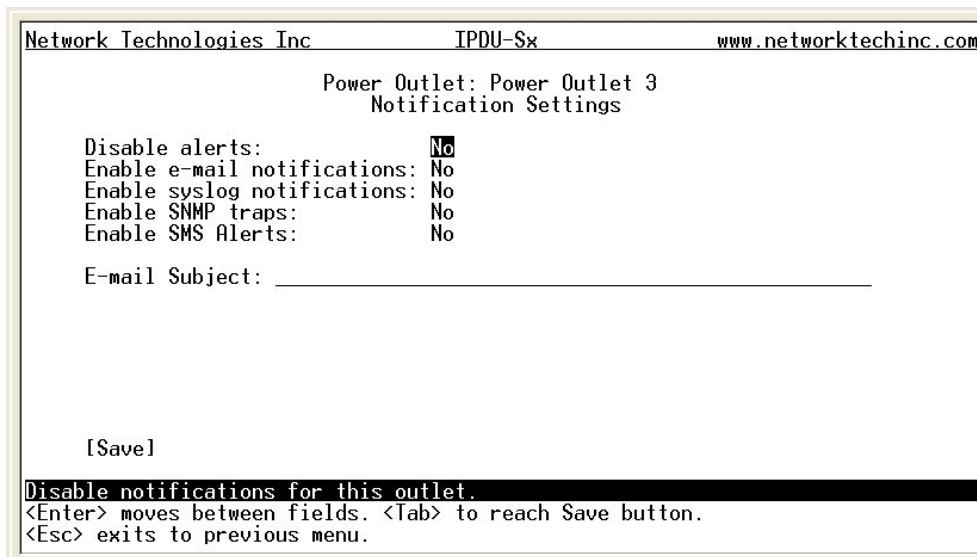

Figure 76- Text Menu-Power Outlet Notification Settings

Alert Settings	
Disable alerts	Change to "Yes" to prevent notifications from being sent when this outlet is in an alert state
Enable Email Alerts	Change to "Yes" to have alert notifications sent via Email
Enable Syslog Alerts	Change to "Yes" to have alert notifications sent via Syslog messages
Enable SNMP traps	Change to "Yes" to have alert notifications sent via SNMP traps (v2c)
Enable SMS Alerts	Change to "Yes" to have alert notifications sent via SMS (requires GSM modem)
Email Subject	Enter the subject to be viewed when an email alert message is received

Press <Tab> to highlight **Save** and press <Enter> to save before pressing <Esc> to exit.

Power Outlet Operation Settings

From the Outlet Operation Settings menu the user can configure the mode of operation for the outlet and how it will function when configured for Periodic mode.

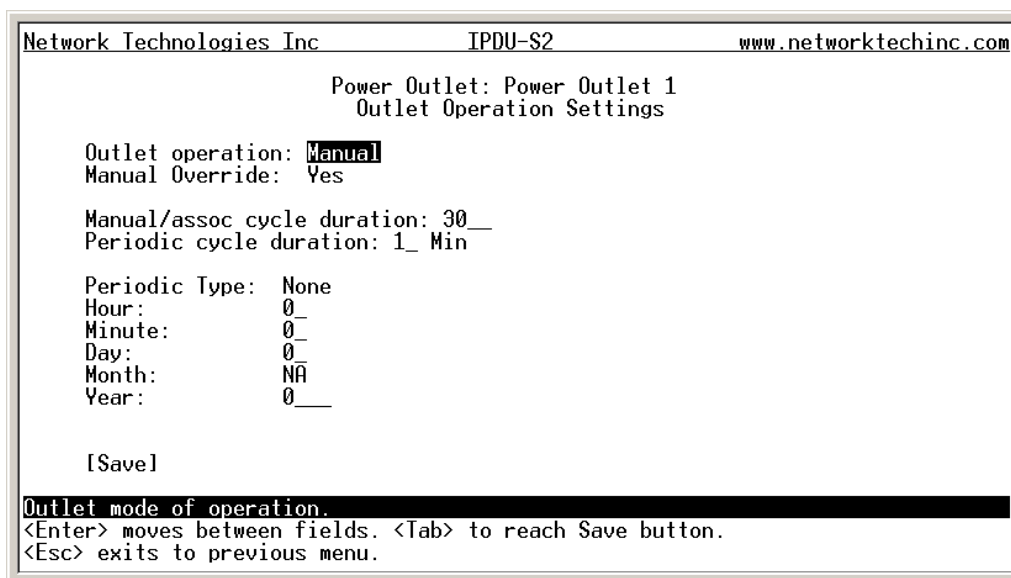

Figure 77- Text Menu-Power Outlet Operation Settings

Outlet Operation Settings	
Operation Mode	Choose between Manual, Periodic, or Associated operating modes for the outlet
Manual Operation Changes Mode	Change to "Yes" if you want the operating mode to be forced into Manual mode if you manually override the outlet status from the Power Outlet Status page (page 62)
Manual/Assoc Cycle Duration	Time period (1-300 seconds) the outlet will remain OFF during a manual power cycle or an associated power cycle
Periodic Cycle Duration	Time period in minutes or hours the outlet will remain OFF during a periodic power cycle
Periodic Type	If the operation mode is set to periodic, choose the type of periodic schedule between one time, daily, weekly, monthly, or none
Periodic Hour	Choose which hour of the day for the periodic cycle to occur (00-23)
Periodic Minute	Choose the minute within the hour of the day for the periodic cycle to occur (00-59)
Periodic Day	Choose the day for the periodic cycle to occur (for one-time and monthly settings, enter a value between 1-31; for weekly setting, enter a value 1-7, Sun = 1, Mon=2Sat = 7)
Periodic Month	Choose which month of the year for the periodic cycle to occur. This only applies when the Periodic Type is set to "one time".
Periodic Year	Enter the year for the periodic cycle to occur. This only applies when the Periodic Type is set to "one time".

Press <Tab> to highlight **Save** and press <Enter> to save before pressing <Esc> to exit.

More about Operation Modes

In Manual Mode, the outlet will only power cycle when it is performed through the Power Outlet Status page (web interface) or through the text menu.

In Periodic Mode, the outlet will power cycle based on the settings configured as described in the table above.

In Associated Mode, the outlet can be controlled based on the alert status of a sensor or IP address. When configured to do so (page 24), the outlet can be powered ON or OFF when a sensor is in alert mode, and/or when it returns to normal state, or power cycled when an IP Device is in alert mode.

Note: An outlet configured for Associated or Periodic operating mode can be manually powered ON/OFF. If “Manual Override Mode is selected, manually changing the ON/OFF state of an outlet configured for Associated Mode or Periodic Mode will change the operating mode to Manual Mode until the outlet is reconfigured.

Configure Sensors

The Configure Sensors menu lists the sensors connected to the IPDU-Sx. Press <Enter> to open the configuration menu for the selected sensor.

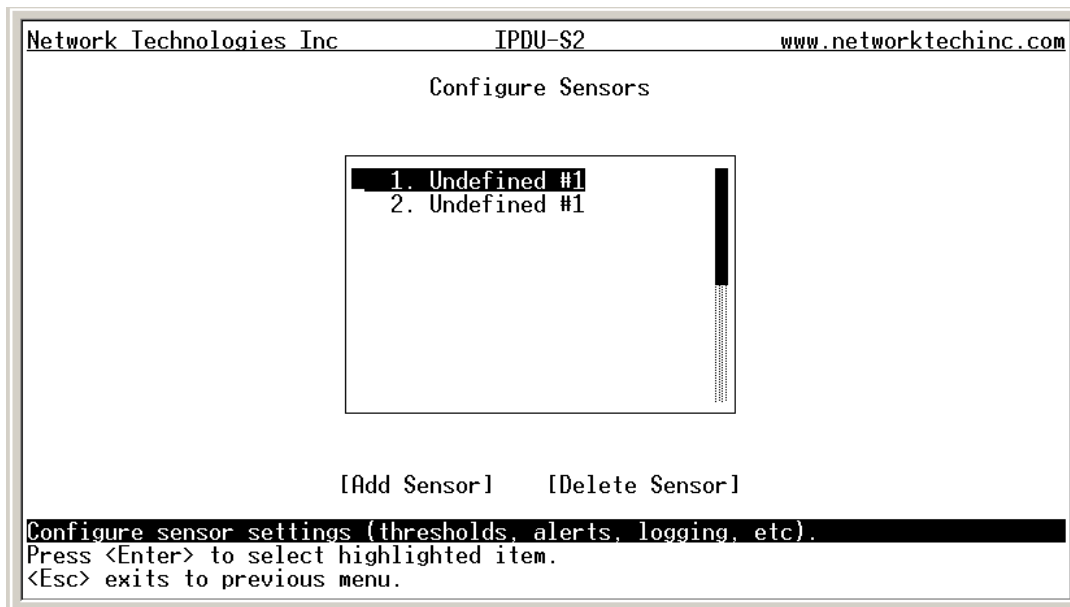

Figure 78- Text Menu-Configure Sensors list

The configuration menu for the sensor includes options to enter the Sensor Settings, Alert Settings, and Data Logging, Power Outlet Association Settings.

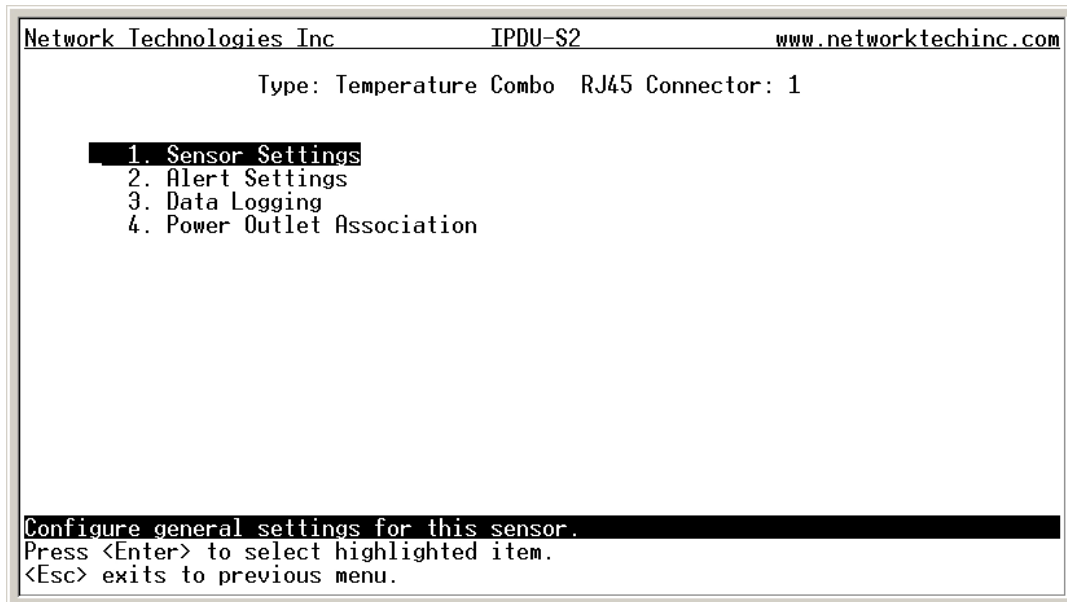

Figure 79- Text Menu-Configuration Menu for Sensor

From the Sensor Settings menu enter the Description for the sensor and select which sensor group the sensor should belong to (1 or 2).

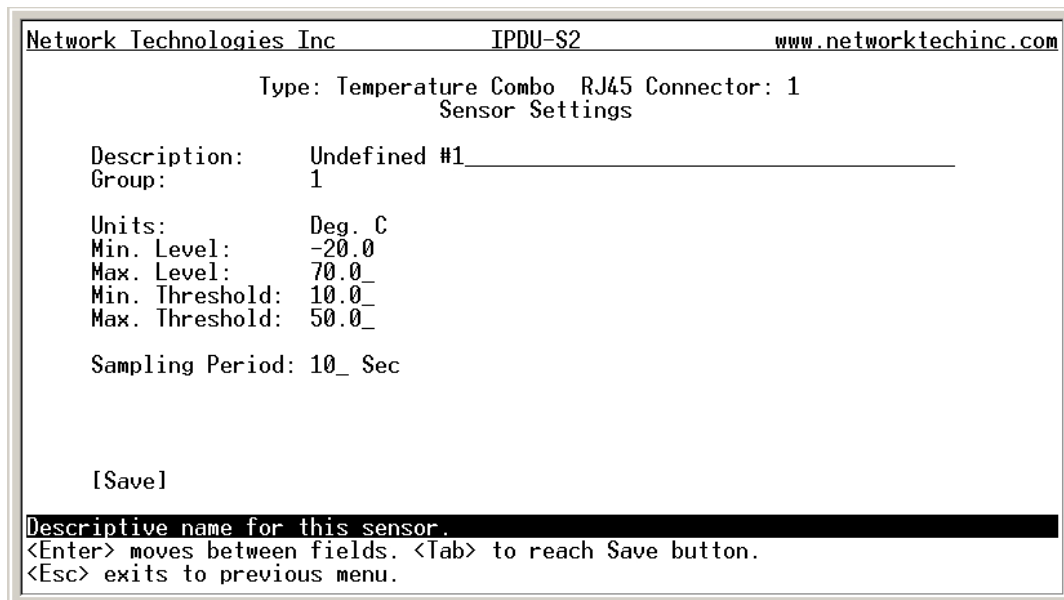

Figure 80- Text Menu-Sensor Settings

Sensor Settings	Description
Description	The description of the sensor that will be viewed in the Summary page and in the body of alert messages
Group	Assign the sensor to either group 1 or 2 (see also page 45)
Units	This lets the operator choose between Celsius and Fahrenheit as the temperature measurement unit.
Min. Level	Displays the minimum value that this sensor will report
Max. Level	Displays the maximum value that this sensor will report
Minimum Threshold	The user must define the lowest acceptable value for the sensors. If the sensor measures a value below this threshold, the sensor will move to alert status. The assigned value should be within the range defined by Minimum Level and Maximum Level and lower than the assigned Maximum Threshold value. If values out of the range are entered, an error message will be shown.
Maximum Threshold	The user must define the highest acceptable value for the sensors. If the sensor measures a value above this threshold, the sensor will move to alert status. The assigned value should be within the range defined by Minimum Level and Maximum Level and higher than the assigned Minimum Threshold value. If values out of the range are entered, an error message will be shown.
Sampling Period	Determines how often the displayed sensor value is refreshed on the Sensor page. A numeric value and a measurement unit (minimum 1 seconds, maximum 999 minutes) should be entered.

Press <Tab> to highlight **Save** and press <Enter> to save before pressing <Esc> to exit.

From the Alert Settings menu, the user can enable/disable alert messages to be sent when the sensor is in an alert state and configure when and how alert messages are sent.

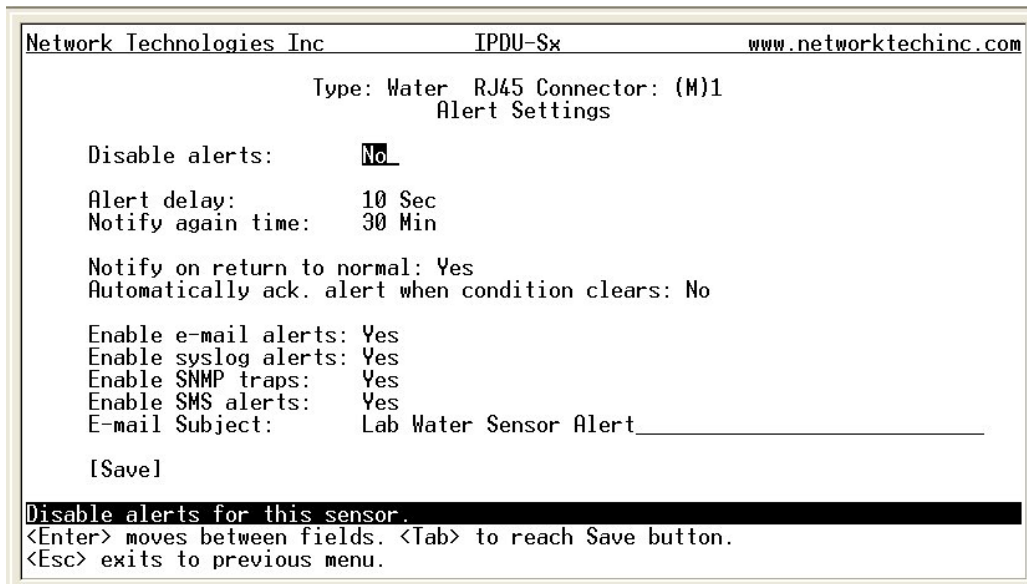

Figure 81- Text Menu-Sensor Alert Settings

Alert Settings	
Disable alerts	Change to "Yes" to prevent alerts from being sent when this sensor's status changes
Alert Delay	The alert delay is an amount of time the sensor must be in an alert condition before an alert is sent. This provides some protection against false alarms. The Alert Delay value can be set for 0-999 seconds or minutes.
Notify Again Time	Enter the amount of time in seconds, minutes, or hours (1-999) before an alert message will be repeated
Notify on Return to Normal	The user can also be notified when the sensor readings have returned to the normal range by changing to "Yes" for " Notify on return to normal " for a sensor.
Auto Acknowledge	Change to "Yes" to have alert notifications in the summary page return to normal state automatically when sensor readings return to normal.

Alert Settings	
Enable Email Alerts	Change to "Yes" to have alert notifications sent via Email
Enable Syslog Alerts	Change to "Yes" to have alert notifications sent via Syslog messages
Enable SNMP traps	Change to "Yes" to have alert notifications sent via SNMP traps (v2c)
Enable SMS Alerts	Change to "Yes" to have alert notifications sent via SMS (requires GSM modem)
Email Subject	Enter the subject to be viewed when an email alert message is received

Press <Tab> to highlight **Save** and press <Enter> to save before pressing <Esc> to exit.

From the Data Logging menu for the sensor, the user can decide if the data sampled should be recorded in the Data Log and how frequently.

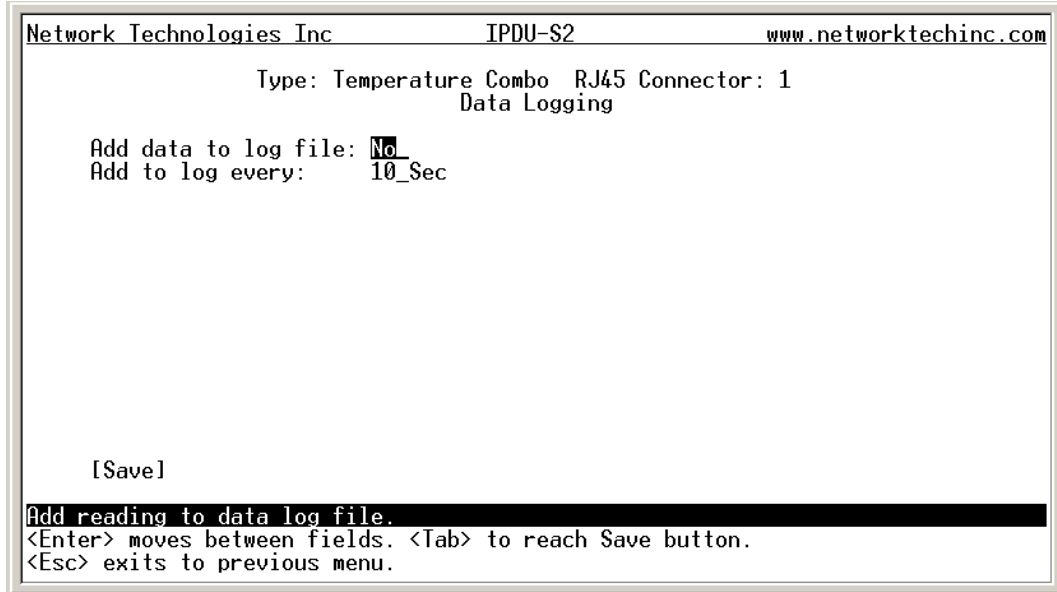

Figure 82- Text Menu-Sensor Data Logging

From the Power Outlet Association menu for the sensor, the user can configure the functionality of a power outlet associated with a sensor's operation.

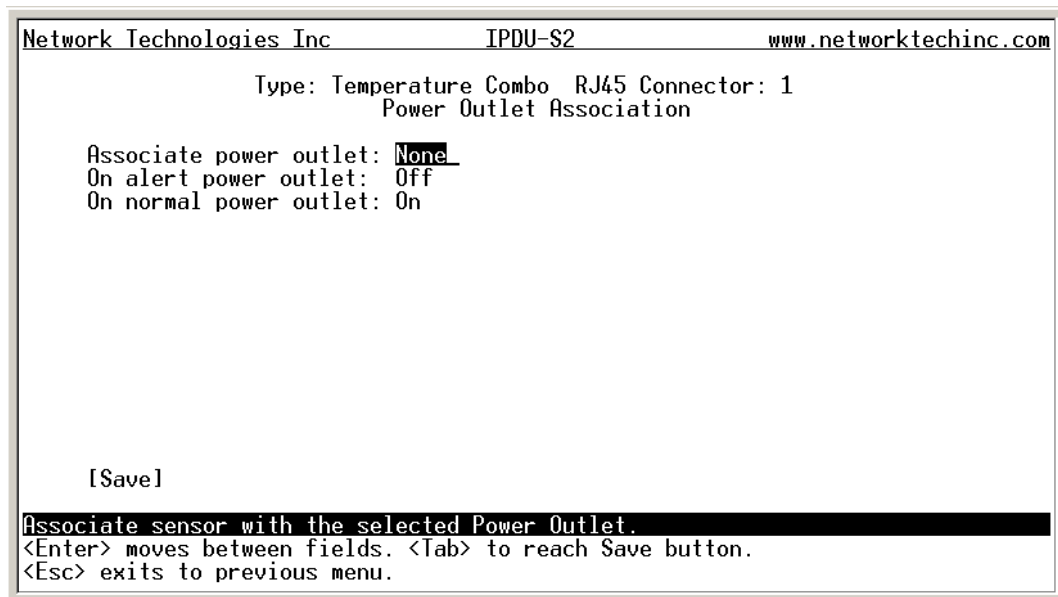

Figure 83- Text Menu- Sensor Power Outlet Association

Power Outlet Association	
Associated outlet	Select which outlet (if any) will be powered ON or OFF when the sensor is in an alert state. For this to take effect, the outlet must be configured for Associated Operation Mode (page 19)
Alert State	State the outlet should be in when the sensor enters an alert state
Normal State	State the outlet should be in when the sensor returns to normal state

Press <Tab> to highlight **Save** and press <Enter> to save before pressing <Esc> to exit.

Configure Line Monitor Parameters

Each of the line parameters for the power going through the outlets on the IPDU-Sx (IPDU-S4 and IPDU-S8 only) can be configured just as the sensors are configured (page 67) to send alerts, log data, and control power outlets. With these tools you can be notified if any parameter goes outside the desired operating range.

The image below shows that the line parameters for each unit connected in a cascaded configuration (page 85) are monitored separately.

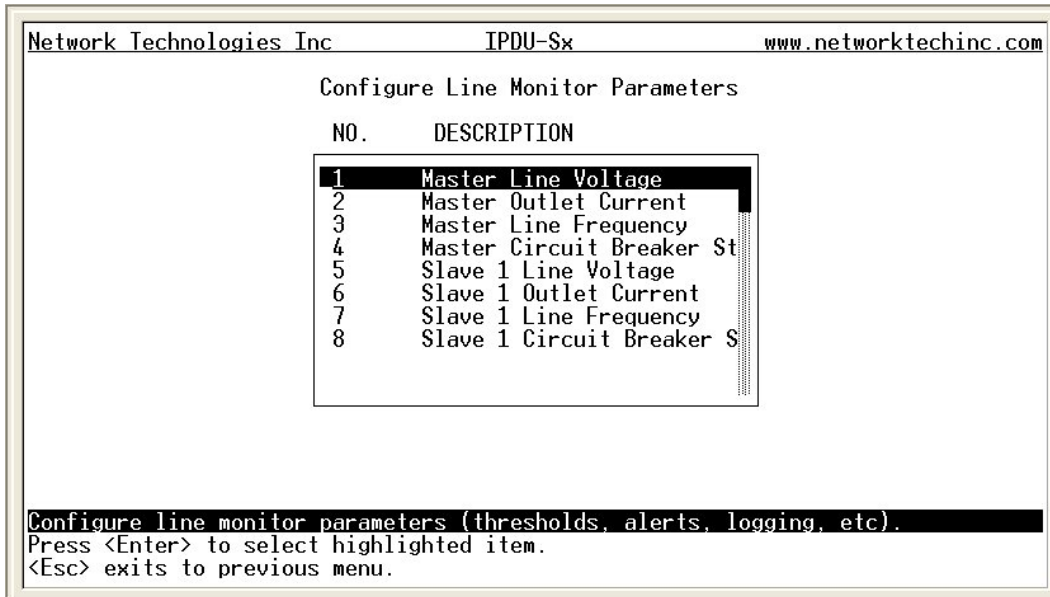

Figure 84- Configure Line Monitor Parameters

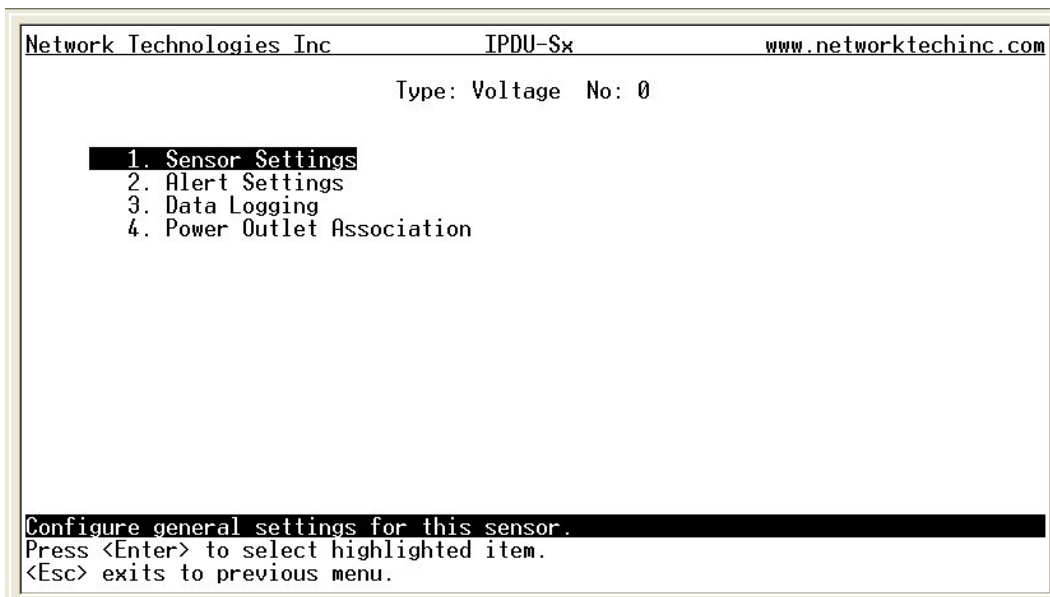

Figure 85- Configuration Menus

Configure IP Devices

The Configure IP Devices menu lists the IP Devices monitored by the IPDU-SX. Press <Enter> to open the configuration menu for the selected IP Device.

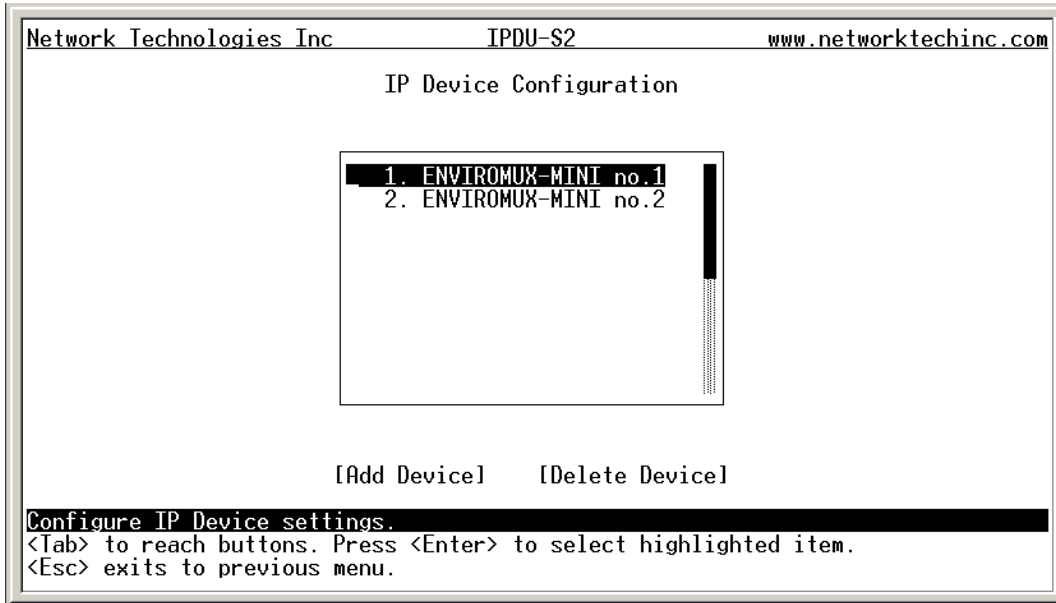

Figure 86- Text Menu-Configure IP Devices List

The configuration menu for the IP Device includes options to enter the IP Device Settings, Alert Settings, and Data Logging, Power Outlet Association Settings.

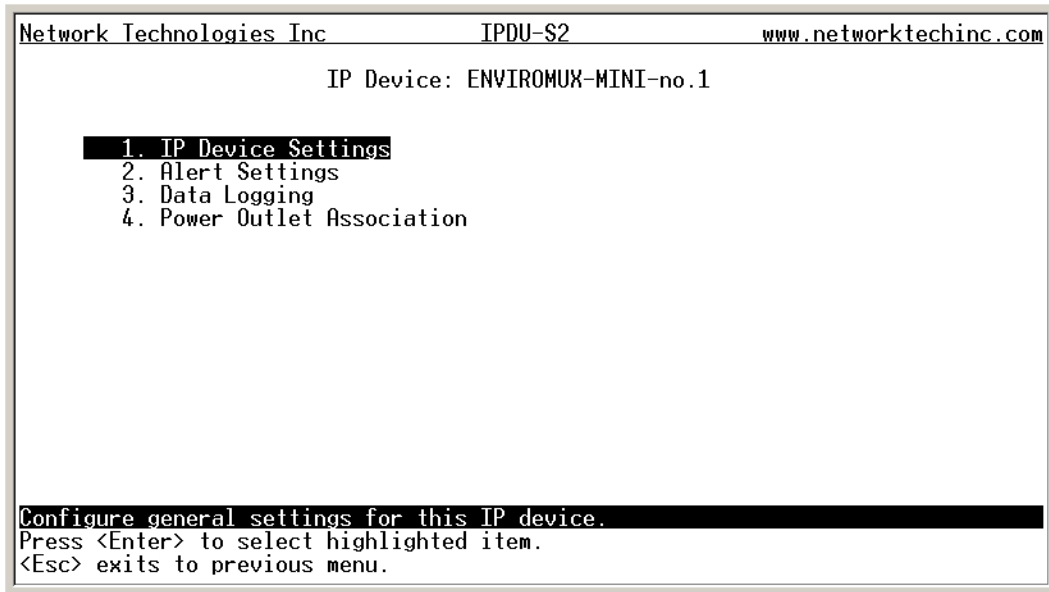

Figure 87- Text menu-Configuration Menu for IP Devices

From the IP Device Settings menu, the user can enter the name and address of the IP Device, assign a sensor group, and define how the IP Device will be monitored.

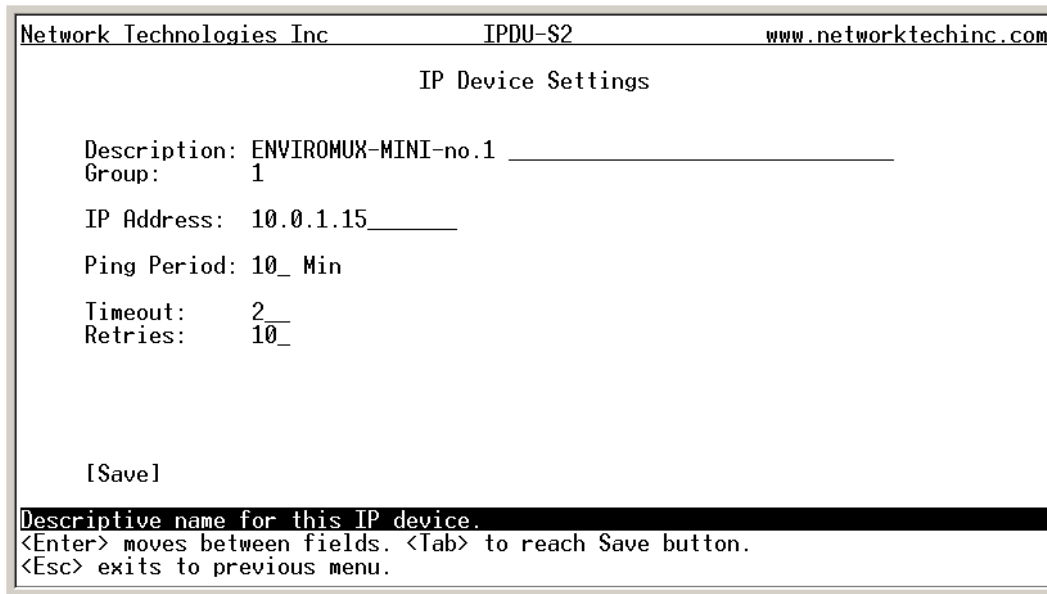

Figure 88-Text Menu-IP Device Settings

IP Device Settings	Description
Description	The description of the IP Device that will be viewed in the Summary page and in the body of alert messages
Group	Assign the IP device to either group 1 or 2
IP Address	The IP address of the IP Device
Ping Period	Enter the frequency in minutes or seconds that the IPDU-SX should ping the IP Device
Timeout	Enter the length of time in seconds to wait for a response to a ping before considering the attempt a failure
Retries	Enter the number of times the IPDU-SX should ping a non-responsive IP device before changing its status from normal to alarm and sending an alert

Press <Tab> to highlight **Save** and press <Enter> to save before pressing <Esc> to exit.

From the Alert Settings menu, the user can enable/disable alert messages to be sent when the IP Device is in an alert state and configure when and how alert messages are sent. The alert settings and data logging are the same as for sensor configuration, described on page 69. Under Power Outlet Association, if the IP device is connected to one of the power outlets on the IPDU-Sx, the IPDU-Sx can automatically cycle the power to the chosen outlet when the IP device is determined to be in a state of alarm. The power cycle characteristics will be those configured under the power outlet configuration under “Power Outlet Operation Settings” (page 66).

From the Alert Settings menu, the user can enable/disable alert messages to be sent when the IP Device is not responding and configure when and how alert messages are sent.

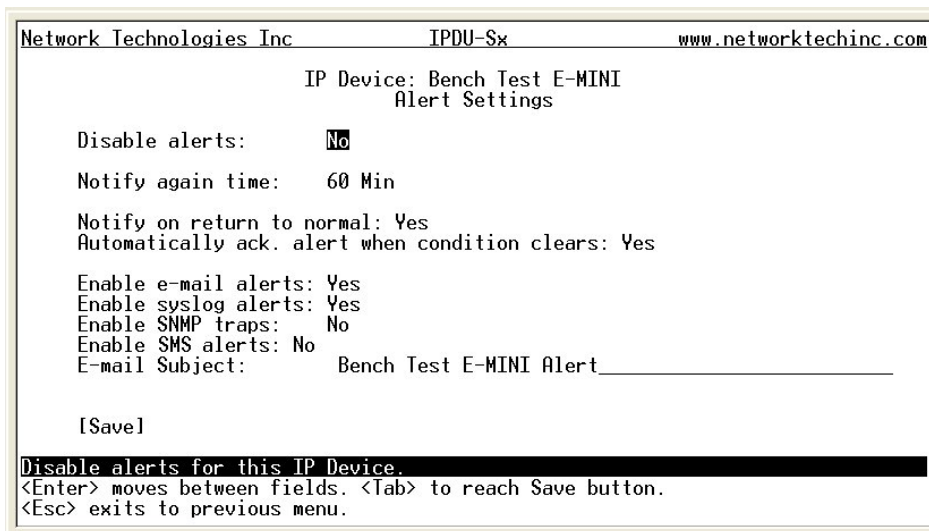

Figure 89- Text Menu-IP Device Alert Settings

Alert Settings	
Disable alerts	Change to “Yes” to prevent alerts from being sent when this IP Device’s status changes
Alert Delay	The alert delay is an amount of time the IP Device must be in an alert condition before an alert is sent. This provides some protection against false alarms. The Alert Delay value can be set for 0-999 seconds or minutes.
Notify Again Time	Enter the amount of time in seconds, minutes, or hours (1-999) before an alert message will be repeated
Notify on Return to Normal	The user can also be notified when the IP Device’s state has returned to the normal by changing to “Yes” for “ Notify on return to normal ” for a sensor.
Auto Acknowledge	Change to “Yes” to have alert notifications in the summary page return to normal state automatically when sensor readings return to normal.
Enable Email Alerts	Change to “Yes” to have alert notifications sent via Email
Enable Syslog Alerts	Change to “Yes” to have alert notifications sent via Syslog messages
Enable SNMP traps	Change to “Yes” to have alert notifications sent via SNMP traps (v2c)
Enable SMS Alerts	Change to “Yes” to have alert notifications sent via SMS (requires GSM modem) (IPDU-S4/S8 only)
Email Subject	Enter the subject to be viewed when an email alert message is received

Press <Tab> to highlight **Save** and press <Enter> to save before pressing <Esc> to exit.

From the Data Logging menu for the IP Device, the user can decide if the data sampled should be recorded in the Data Log and how frequently.

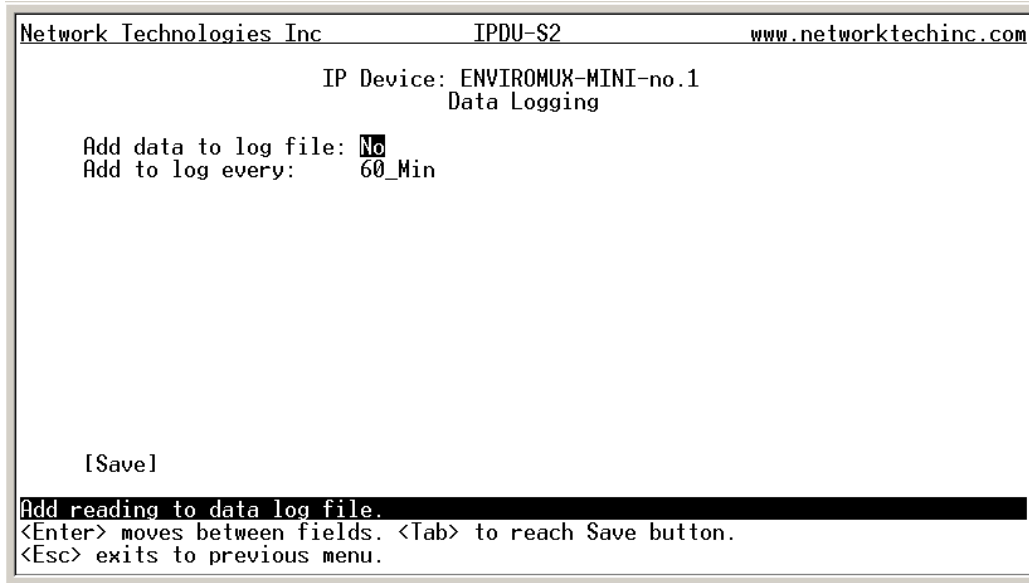

Figure 90- Text Menu-IP Device Data Logging

From the Power Outlet Association menu for the IP Device, the user can configure which power outlet is associated with a IP Device's operation. If the IP device is connected to one of the power outlets on the IPDU-Sx, the IPDU-Sx can automatically cycle the power to the chosen outlet when the IP device is determined to be in a state of alarm. The power cycle characteristics will be those configured under the power outlet configuration under "Power Outlet Operation Settings" (page 66).

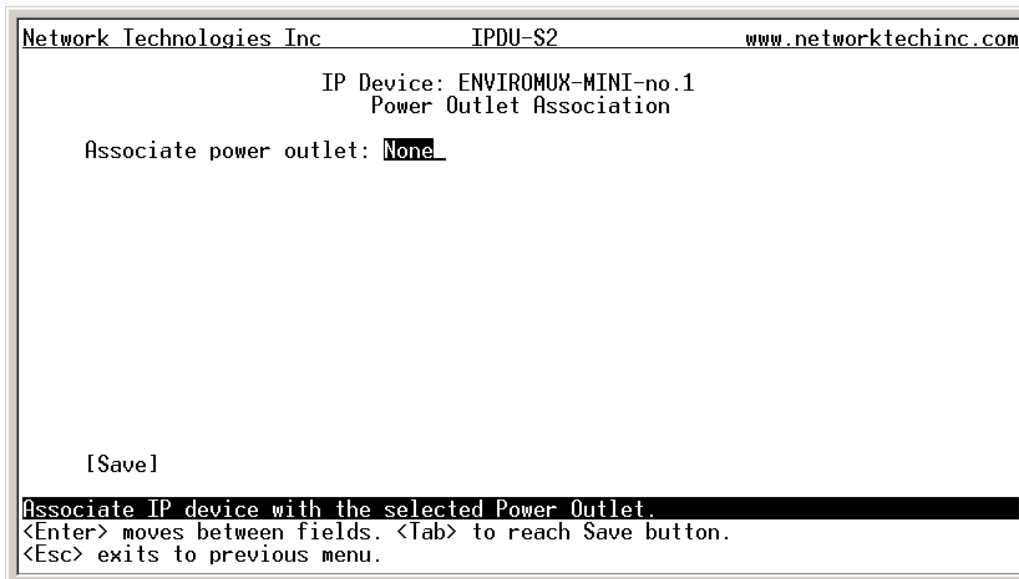

Figure 91- Text Menu-IP Device Power Outlet Association

System Configuration

Under System Configuration (from the Main Menu), select “Time Settings” to enter the time of day, time zone, enable daylight saving time, or NTP server settings. Also, select “Restore Settings to Defaults” to clear all configuration and user settings and restore the IPDU-Sx to settings as received from the factory.

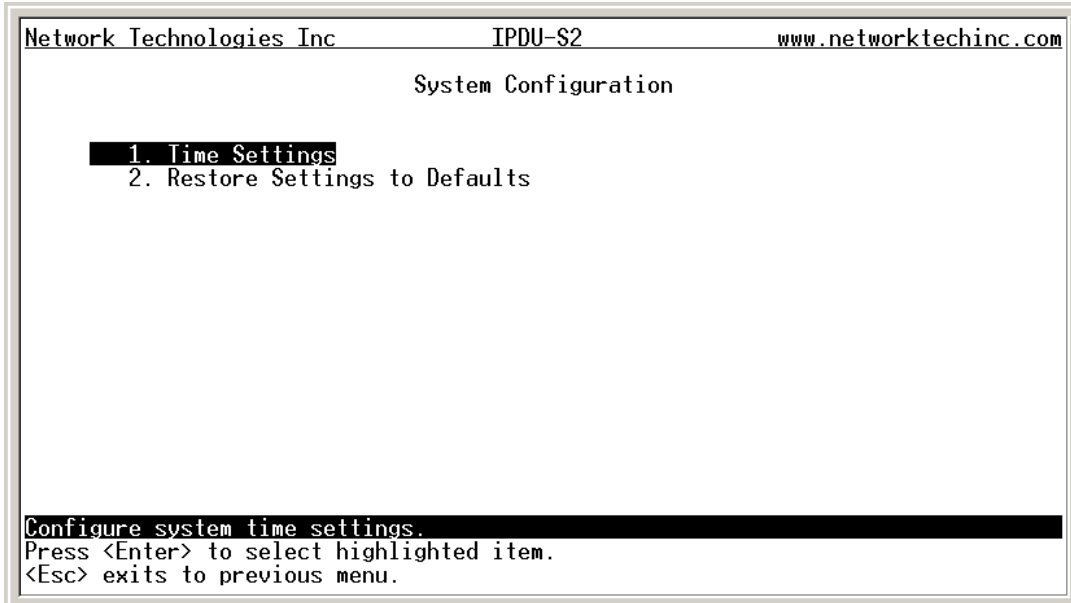

Figure 92- Text Menu- System Configuration

Time Settings

On the Time Settings menu, the user can designate what time zone the unit is associated with, set the date and time manually or configure the IPDU-Sx to get this information from an NTP server.

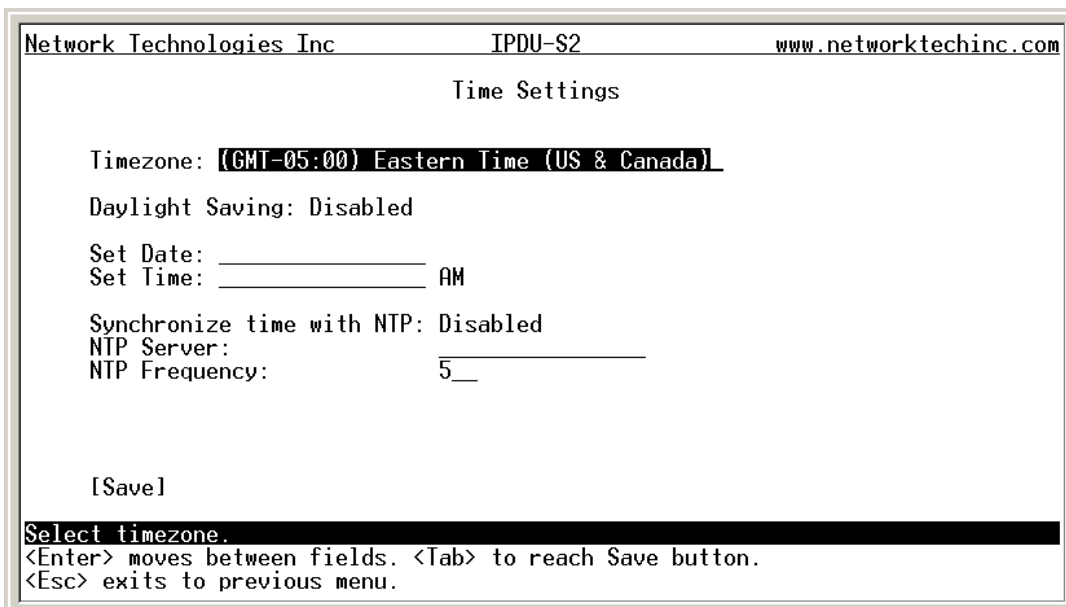

Figure 93- Text Menu-Time Settings menu

Time Settings	Description
Time Zone	Enter the appropriate time zone
Enable Daylight Saving	Change to "Yes" to have the time change in accordance Daylight Saving Time rules
Set Date	Enter the system date in MM-DD-YYYY format
Set Time	Enter the system time of day in hh:mm:ss format
Enable NTP	Change to "Enabled" to allow the IPDU-SX to automatically sync up with a time server via NTP
NTP server	If the NTP is enabled, enter the IP address of the NTP server
NTP Frequency	Enter the frequency (in minutes) for the IPDU-SX to query the NTP server (minimum is 5 minutes)

Press <Tab> to highlight **Save** and press <Enter> to save before pressing <Esc> to exit.

Restore Default Settings

Select this option to restore the IPDU-Sx to the configuration settings it had upon receipt from the factory. **Be careful!** This will erase all user configuration settings. Upon restoration, the IPDU-Sx will reboot. Allow 1 minute before trying to reconnect and log in again.

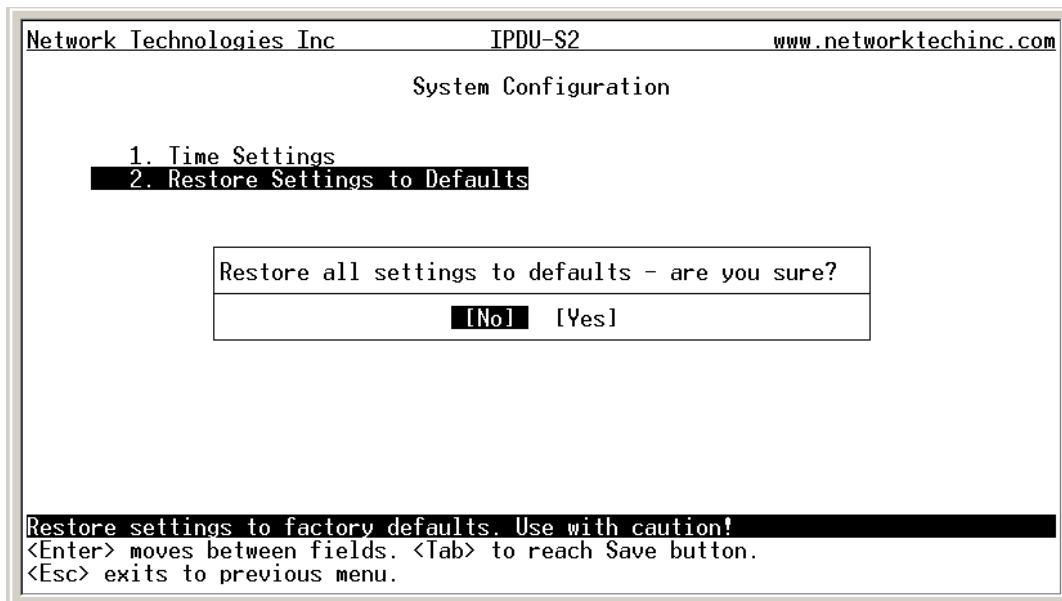

Figure 94- Text Menu-Restore Default Settings

Note: If "Restore Defaults" is used, the IP address will also be restored to its default address of 192.168.1.22 with a login name "root" and password "nti". To restore the root password to "nti" without having to restore all default settings, contact NTI for assistance.

To identify the IP address of the IPDU-Sx without restoring defaults, use the Discovery Tool (page 13).

Enterprise Configuration

Under Enterprise Configuration (from the Main Menu), enter the unit name, location, the contact person emails should refer to and their phone number, and the email address of the IPDU-Sx to be used for outgoing alert messages.

```

Network Technologies Inc          IPDU-S2          www.networktechinc.com
                                Enterprise Configuration

Enterprise Name:  Unit Name_____
Location:        Unit Location___

Contact:         Contact Person__
Phone:          Phone No_____
E-mail:         ipdus2@company.com_____

[Save]

Set enterprise name.
<Enter> moves between fields. <Tab> to reach Save button.
<Esc> exits to previous menu.

```

Figure 95- Text Menu-Enterprise Configuration

Network Configuration

The Network Configuration menu (from the Main Menu) includes submenus for applying IP Settings, SMTP server settings, SNMP settings, miscellaneous settings to enable services for SSH, Telnet, HTTP, HTTPS and Web Timeout, and settings to support up to three IP Aliases.

```

Network Technologies Inc          IPDU-Sx          www.networktechinc.com
                                Network Configuration

1. IP Settings
2. SMTP Settings
3. SNMP Settings
4. Misc. Service Settings
5. IP Alias1 Settings
6. IP Alias2 Settings
7. IP Alias3 Settings

Configure IP settings.
Press <Enter> to select highlighted item.
<Esc> exits to previous menu.

```

Figure 96- Text Menu-Network Configuration

IP Settings

The IP Settings menu contains the network connection settings for the IPDU-Sx.

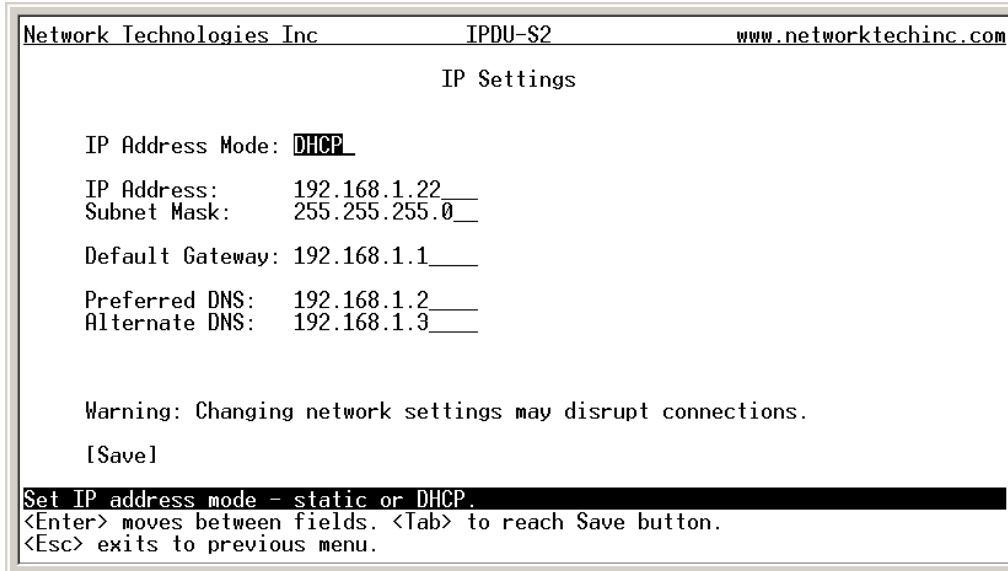

Figure 97- Text Menu-IP Settings Menu

IP Settings	Description
Mode	Select between Static (manual) , or DHCP (automatic IP and DNS) settings
IP Address	Enter a valid IP address (default address shown above)
Subnet Mask	Enter a valid subnet mask (default value shown above)
Default Gateway	Enter a valid gateway (default gateway shown above)
Preferred DNS	Enter a preferred domain name server address
Alternate DNS	Enter an alternate domain name server address

If the administrator chooses to have the DNS and IP address information filled in automatically via DHCP, the SMTP server and port number still need to be entered for email alerts to work. If the SMTP server requires a password in order for users to send emails, the network administrator must first assign a user name and password to the IPDU.

Press <Tab> to highlight **Save** and press <Enter> to save before pressing <Esc> to exit.

SMTP Settings

The SMTP Settings menu contains the SMTP server settings for the IPDU-Sx.

```

Network Technologies Inc          IPDU-S2          www.networktechinc.com
                                SMTP Settings

SMTP Server: _____
SMTP Port:    25____

Use SSL:      No

Requires Auth: No
SMTP User:   _____
SMTP Password: _____

[Save]

SMTP server for sending e-mail messages.
<Enter> moves between fields. <Tab> to reach Save button.
<Esc> exits to previous menu.
    
```

Figure 98- Text Menu-SMTP Server Settings

SMTP Settings	Description
SMTP Server	Enter a valid SMTP server name (e.g. yourcompany.com)
Port	Enter a valid port number (default port is 25)
Use SSL	Change to "Yes" if the SMTP server supports SSL
Use Authentication	Change to "Yes" if the SMTP server requires authentication to send email
Username	Enter a valid username to be used by the IPDU-SX to send emails
Password	Enter a valid password assigned to the IPDU-SX username

Note: The SMTP server port number is shown in Figure 96 as "25". This is a common port number assigned, but not necessarily the port number assigned to your SMTP server. For SMTP servers that support SSL, the common port number is 465.

SNMP Settings

The SNMP Settings menu contains the SNMP server settings for the IPDU-Sx.

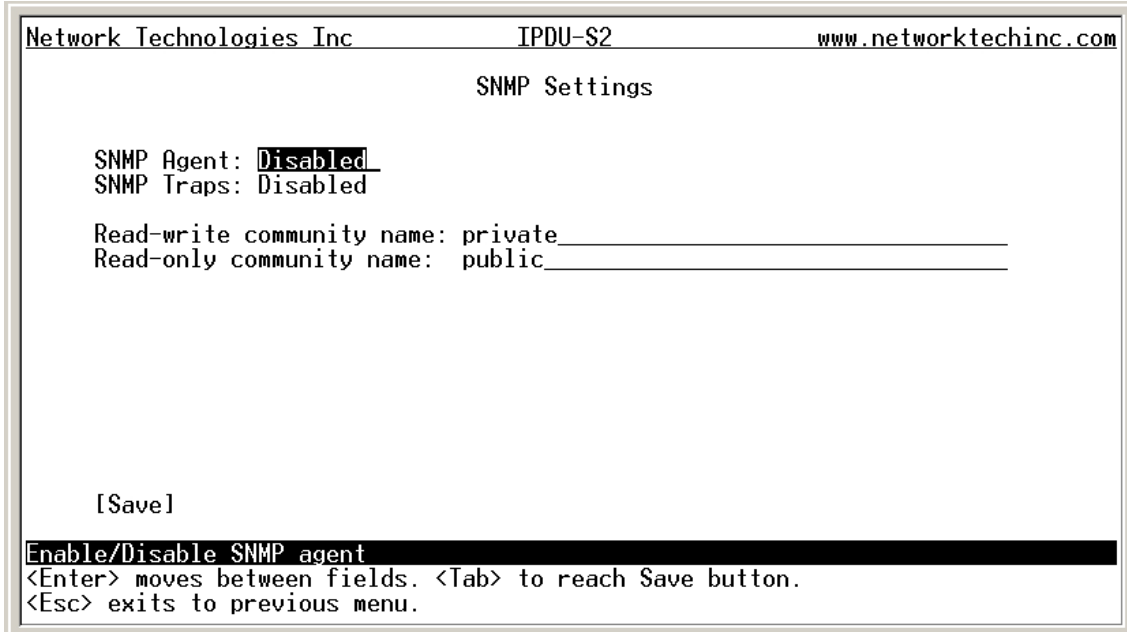

Figure 99- Text Menu-SNMP Server Settings

SNMP Settings	
Enable SNMP agent	Change to "Enabled" to enable access to the SNMP agent
Enable SNMP traps	Change to "Enabled" to enable SNMP traps to be sent
Read-write community name	Enter applicable name (commonly used- "private") (not applicable as of this printing)
Read-only community name	Enter applicable name (commonly used- "public")

Read-Only Community Name

The SNMP Read-only community name enables a user to retrieve "read-only" information from the IPDU-Sx using the SNMP browser and MIB file. This name must be present in the IPDU-Sx and in the proper field in the SNMP browser.

Read-Write Community Name

(not applicable as of this printing)

The SNMP Read-Write community name enables a user to read information from the IPDU-Sx and to modify settings on the IPDU-Sx using the SNMP browser and MIB file. This name must be present in the IPDU and in the proper field in the SNMP browser.

Miscellaneous Service Settings

The Misc. Service Settings menu contains selections to configure services running on the IPDU-Sx.

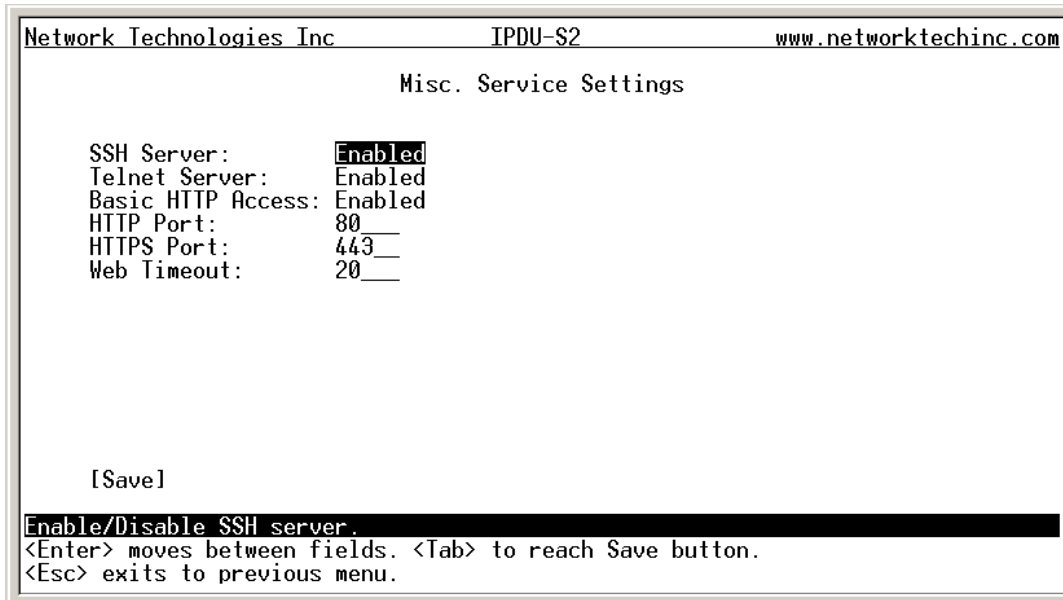

Figure 100- Text Menu-Misc. Service Settings menu

Server Settings	
Enable SSH	Enable this to allow access to the IPDU-SX via SSH
Enable Telnet	Enable this to allow access to the IPDU-SX via Telnet
Enable HTTP access	Enable this to allow access to the IPDU-SX via standard (non-secure) HTTP requests
HTTP Port	Port to be used for standard HTTP requests
HTTPS Port	Port to be used for HTTPS requests
Web Timeout	Number of minutes after which idle web uses will be logged-out (enter 0 to disable this feature)

The administrator may assign a different HTTP Server Port than is used by most servers (80).

Note: If the port number is changed and forgotten, to determine what it has been changed to connect the IPDU-Sx for RS232 control (page 6) and review these settings.

IP Aliases

(Applicable only to IPDU-S4 and IPDU-S8 models.)

```
Network Technologies Inc          IPDU-Sx          www.networktechinc.com
                                IP Alias Settings

IP Alias Address Mode: Disable
IP Alias Address:          192.168.1.104__
IP Alias Subnet Mask:      255.255.255.0__
IP Alias Gateway: 192.168.1.1__

|

Warning: Changing network settings may disrupt connections.
[Save]

Set IP address mode - static or DHCP.
<Enter> moves between fields. <Tab> to reach Save button.
<Esc> exits to previous menu.
```

Figure 101- Text Menu- IP Alias Settings

Up to 3 IP aliases can be configured. This provides added flexibility when access from multiple networks is required.

To use an alias, be sure to change the default Mode to "Enable". Then enter a valid IP address, Subnet Mask and Gateway for the network that will have access to the ENVIROMUX.

Only the primary IP Settings can be assigned by a DHCP server and only the primary settings can have DNS Server settings.

Only the primary IP settings are used for any outgoing connections like alert emails, syslog etc.

Cascade Configuration

Select Cascade Configuration (from the Main Menu) if this feature will be used (IPDU-S4 and IPDU-S8 only). Use cascading to control multiple IPDU-Sx units, connecting them to one another to form a much larger system that can be administered and monitored from one central point. Units can be cascaded using either RS485 or Ethernet connection. When using the RS485 Connection method for cascading the IPDU-Sx will be connected as shown on page 8. If units will be controlled using the Ethernet Connection method, the IPDU-Sx will be connected to a network using the “ETHERNET” port.

In a cascaded configuration, one unit will be the “master” to which each unit is connected as a “slave”. Up to 16 slave units can be connected for a total system configuration of 136 controlled outlets.

Configure the Type

In the Cascade Configuration menu the first setting to configure is the type. Types include:

Type	Description
Master with No Slaves	Stand alone unit, not cascaded
RS485 Slave	Unit will be connected to a master using the “Cascade” ports
Ethernet Slave	Unit will be connected to a master using the Ethernet
RS485 Master	Unit will be the master in a RS485 connected configuration
Ethernet Master	Unit will be the master using the Ethernet

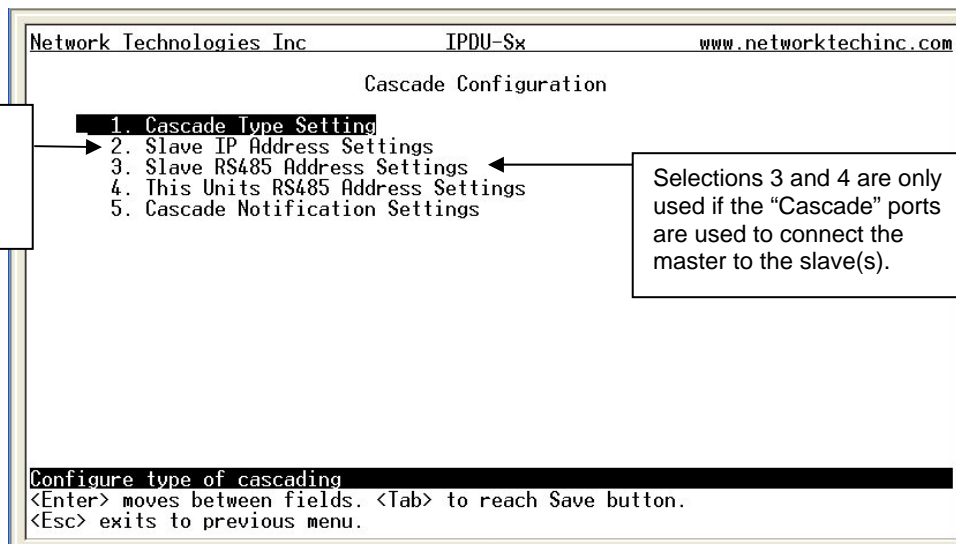

Figure 102- Text Menu- Type Setting for Cascading

RS485 Slave

If the type is **RS485 Slave**, an address number (1-255) must be entered to identify the unit to the master. Each slave on the system must have a unique address number.

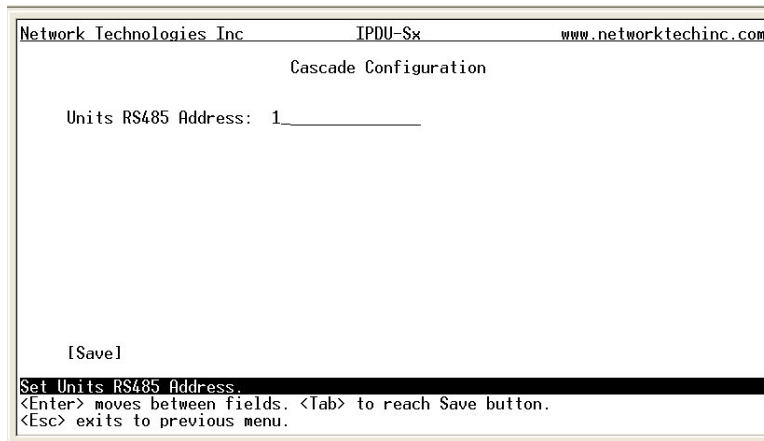

Figure 103- Text Menu- Unit RS485 Address

Ethernet Slave

If the type is **Ethernet Slave**, the Ethernet address entered on the Network Configuration page (page 33) will be used by the master to communicate with this slave. There will be no “slave IP address settings” to enter. Each slave on the system must have a unique IP address.

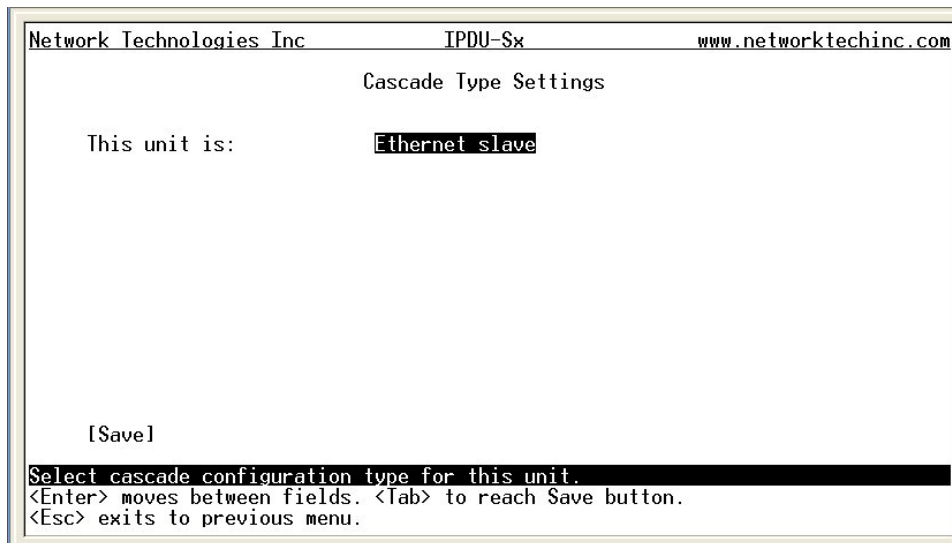

Figure 104- Text Menu- Type is Ethernet Slave

RS485 Master

If the type is **RS485 Master**, then the RS485 addresses for each slave (valid address range of 1-255) must be entered into the available slots (up to 16) in order to communicate between the master and each slave. The RS485 unit address and Slave IP address settings will not apply to this configuration. To configure a slave to be connected, select the desired slave number and press <Enter> to open the “Edit Slave Address” menu.

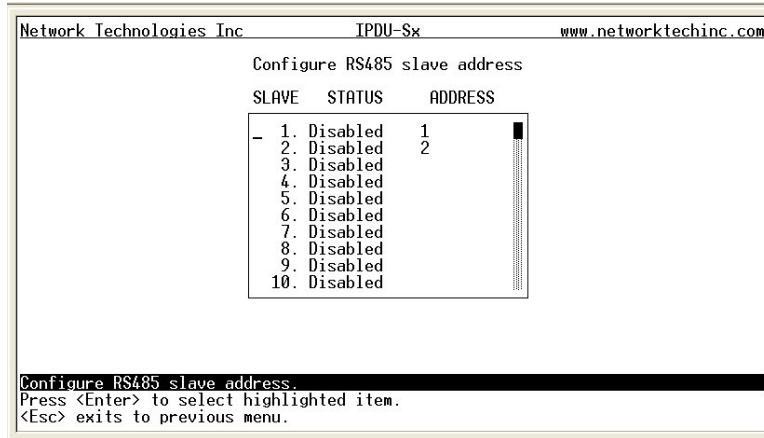

Figure 105- Text Menu- RS485 Master's slave list

In the “Edit Slave Address” menu, the slave can be either enabled (set to establish communication with the slave) or left disabled. If set to enable, be sure to enter a valid unique RS485 address (valid number range is 1-255).

Note: Address values entered outside the valid number range will be accepted by the master, but ignored.

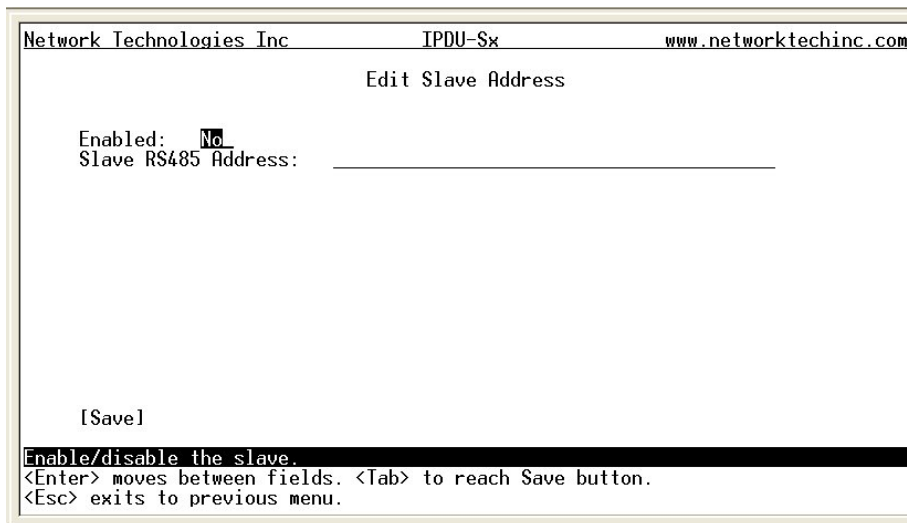

Figure 106- Text Menu- Edit RS485 Slave Address

Ethernet Master

If the type is **Ethernet Master**, then the Slave IP Address Settings (item 2 in the Cascade Configuration menu) must be entered for each slave that will be controlled. RS485 address settings and the RS485 unit address will not apply. To configure a slave to be connected, select the desired slave number and press <Enter> to open the "Edit Slave Address" menu.

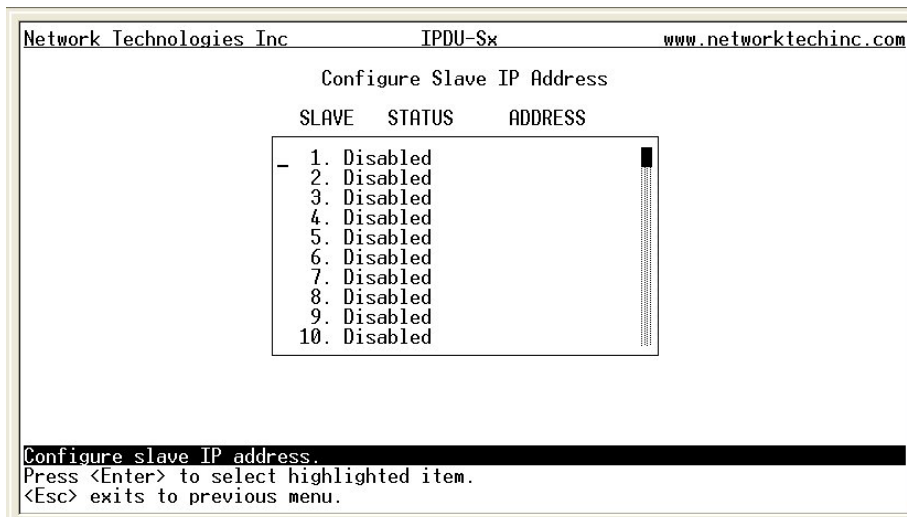

Figure 107- Text Menu- Ethernet Master's slave list

In the "Edit Slave Address" menu, the slave can be either enabled (set to establish communication with the slave) or left disabled. If set to enable, be sure to enter a valid unique IP address.

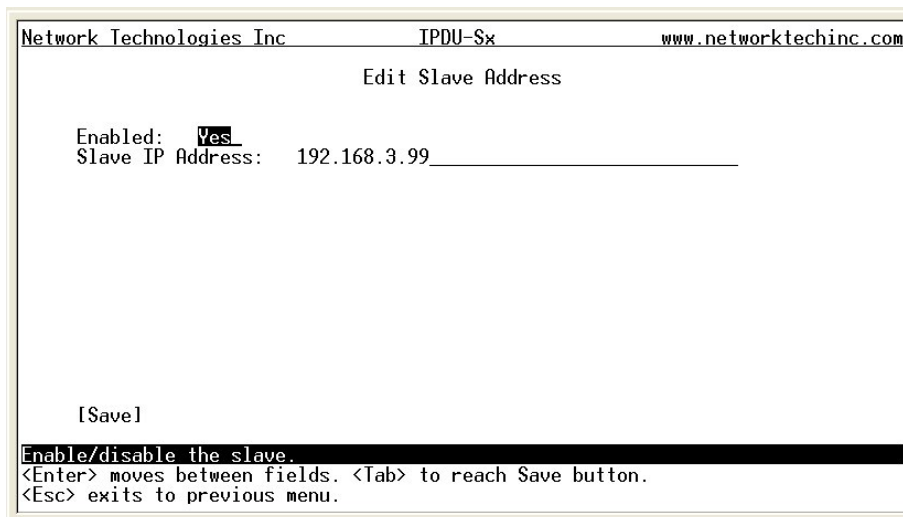

Figure 108-Text Menu- Edit Ethernet Slave Address

Cascade Notification

In the event a slave goes offline from the system, the system can be set to notify those configured to receive messages from the master unit. Selecting 5 from the “Cascade Configuration” menu will open the “Cascade Notification” menu where you can specify how frequent notifications will be repeated. Cascade Notification cannot be disabled.

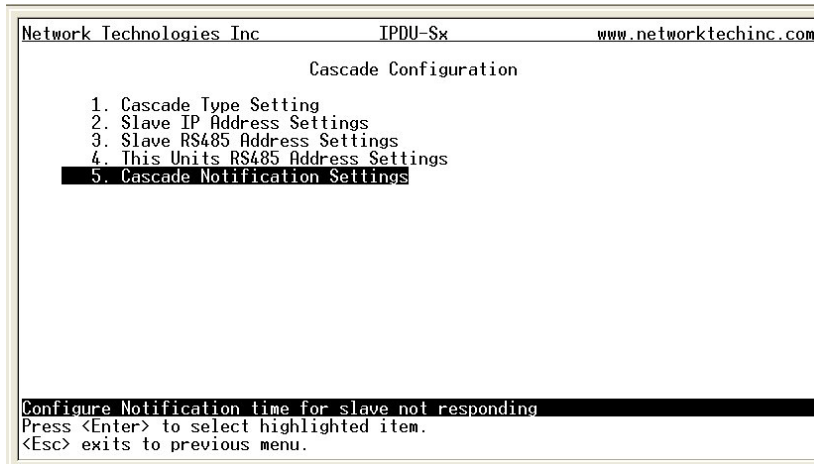

Figure 109- Text Menu-Cascade Notification Settings

An example of the notification you will receive is:

```

11-12-2010 11:18:38 AM      Sensor Not Responding      --      Slave Unit #2 (Unit Name) not
responding
    
```

Suggestion: To avoid receiving unnecessary notifications, don't enable the slave (Figure 106 and Figure 108) when configuring the master until the slave has been fully configured first.

The default time period in which notifications will repeat is every 30 seconds.

To change the value:

1. While the number value is selected, press the <Delete> key to remove the value and type the desired value (range is 1-99). Press <Enter> to move to the units value.
2. Press an arrow key to toggle between seconds (Sec), minutes (Min), or hours (Hr). Press <Enter> again to move to “Save”.
3. Press <Enter> again to save the change, or press <Tab> to return to the number value.

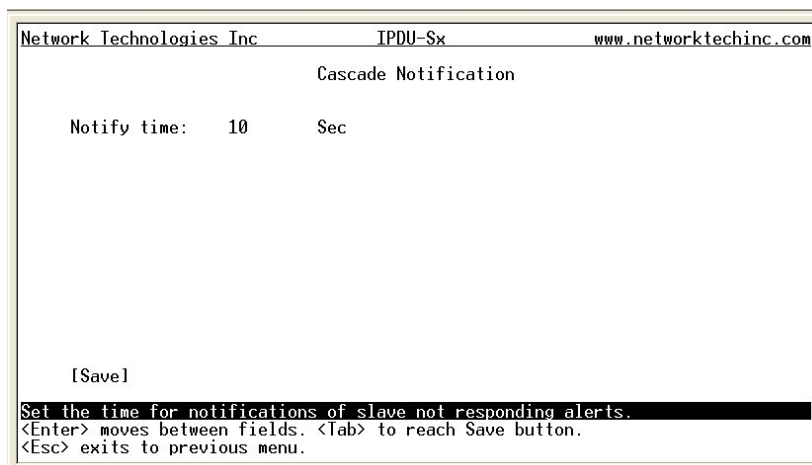

Figure 110- Cascade Notification Configuration

User Configuration

The User Configuration menu lists all configured user names of the IPDU-Sx. A maximum of 15 users (other than root) can be configured. From this screen the administrative user can add users, go to the user configuration page to edit a user's access to the IPDU-Sx, or delete a user from the list.

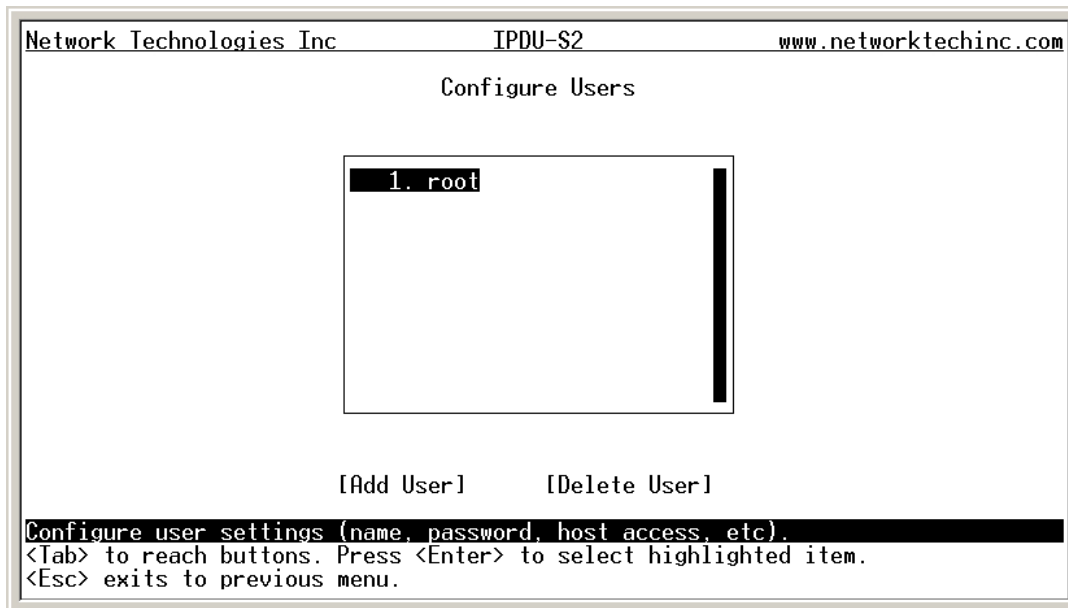

Figure 111- Text Menu-User Configuration

To add a user, Tab to “Add User” and press <Enter>.

To edit a user’s configuration, select the listed username and press <Enter>

To delete a user and their configuration, select a listed username, Tab to “Delete User”, and press <Enter>. You will be prompted for confirmation before deleting the user and configuration.

When adding a new user, you will be prompted to confirm the addition of the user. At that point, the Configure User menu will open a user settings list with the username “userx” assigned, where x = the next consecutive number (up to 15) based on the quantity of users in the list (other than the root user).

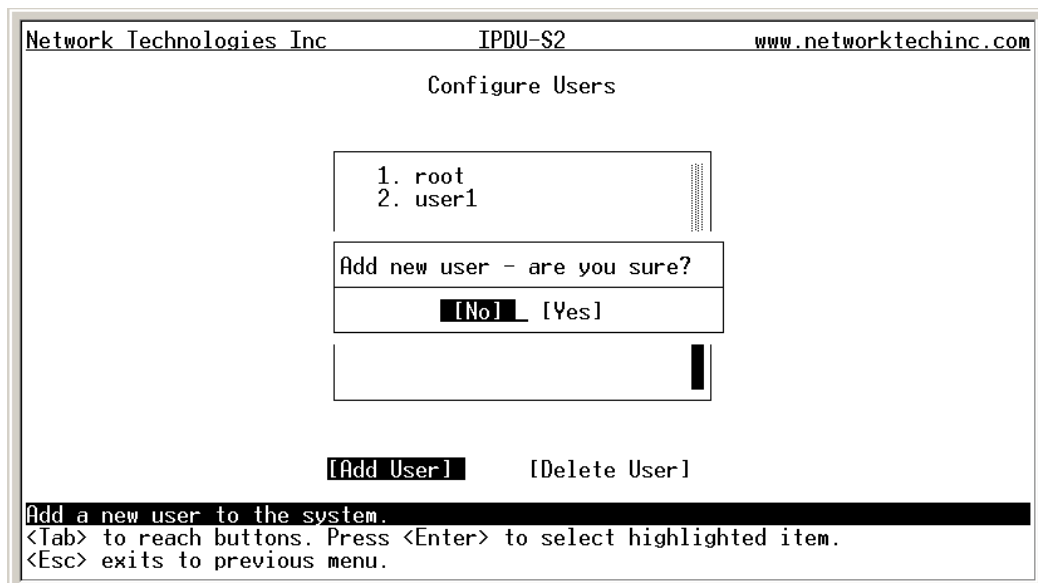

Figure 112- Text Menu-Confirm to add new user

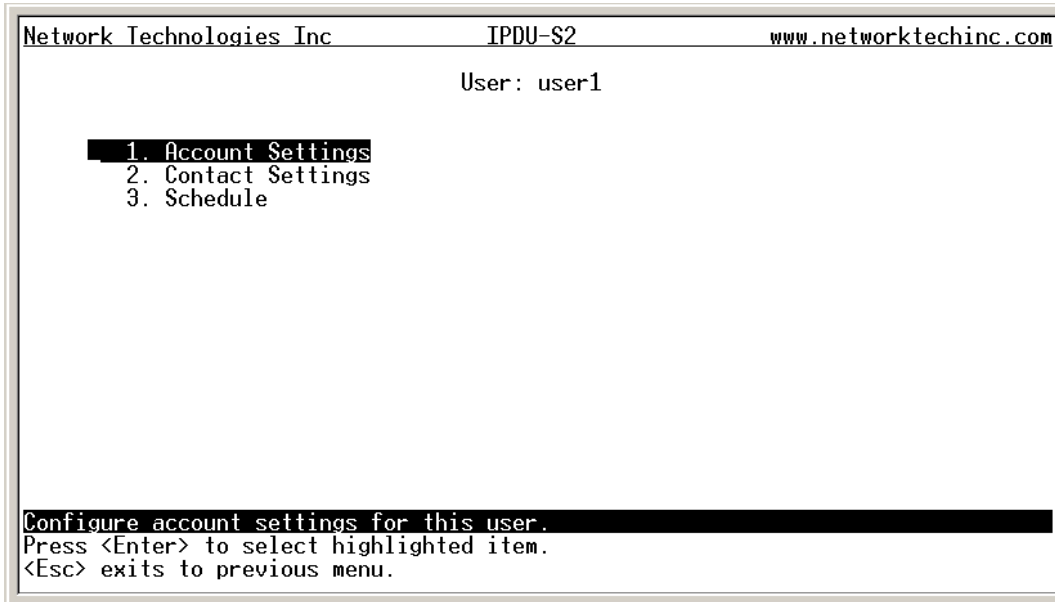

Figure 113- Text Menu-Configuration List for User

User Account Settings

Select “Account Settings” from the list and press <Enter>. A menu with the account settings for that specific user will open where you can either leave the name as “userx”, or change it. With the name assigned, fill in the remaining information as needed.

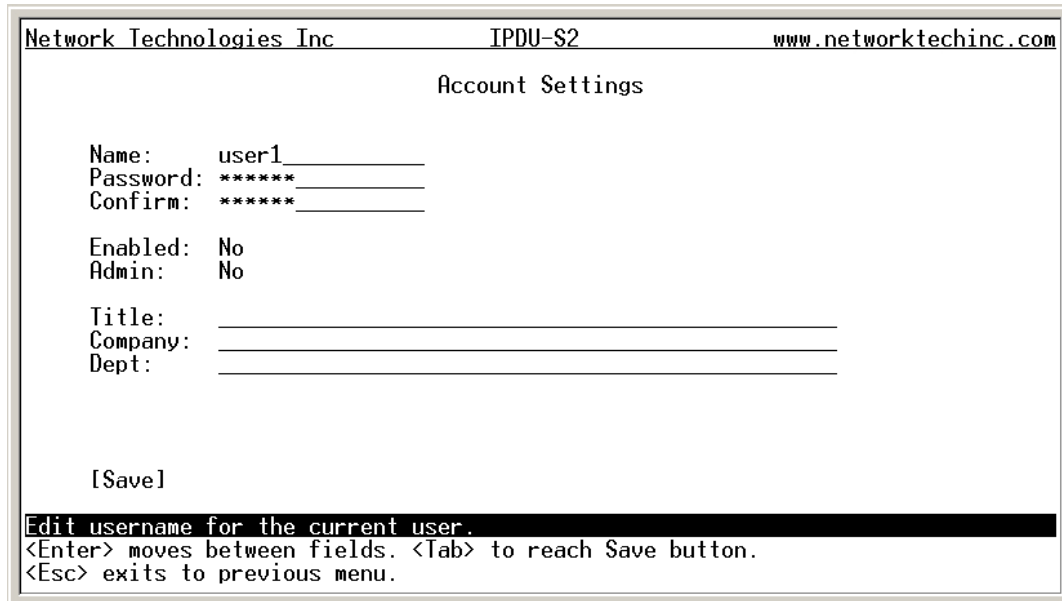

Figure 114- Text Menu-User Account Settings

Account Settings	Description
Username	Enter the desired username for this user
Password	Enter a password that a user must use to login to the system A password must be assigned for the user’s login to be valid Passwords must be at least 1 keyboard character.
Confirm	Re-enter a password that a user must use to login to the system

Account Settings	Description
Enabled	Change to "Yes" to enable this user to access the IPDU-Sx
Admin	Change to "Yes" if this user should have administrative privileges
Title	Enter information as applicable (optional)
Department	Enter information as applicable (optional)
Company	Enter information as applicable (optional)

More about User Privileges

The root user (or any user with administrator rights) can change the root password and configure how the root user will receive alert messages. Users with administrative rights can change all configuration settings except for the root user name.

User Contact Settings

Select "Contact Settings" from the list and press <Enter>. A menu with the contact settings for that specific user will open.

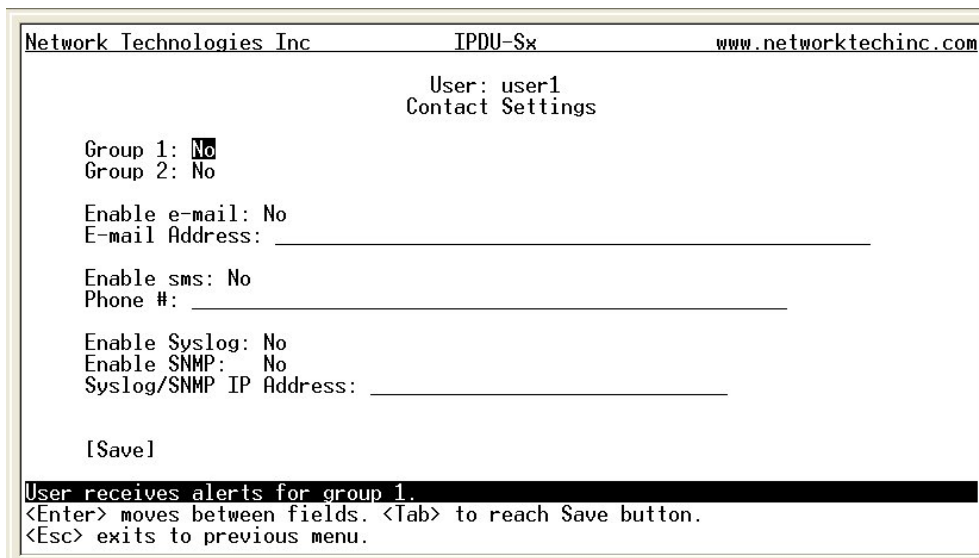

Figure 115- Text Menu-User Contact Settings

Contact Settings	Description
Group 1	Change to "Yes" if the user should receive messages from sensors, IP devices and outlets in Group 1
Group 2	Change to "Yes" if the user should receive messages from sensors, IP devices and outlets in Group 2
Enable Email	Change to "Yes" if the user should receive messages via email
Email address	Enter a valid email address if the user should receive email alert messages
Syslog alerts	Change to "Yes" if the user should receive alerts via syslog messages
SNMP traps	Change to "Yes" if the user should receive alerts via SNMP traps
Syslog/SNMP IP address	Enter a valid syslog/SNMP IP address for the user to receive syslog/SNMP messages

Press <Tab> to highlight **Save** and press <Enter> to save before pressing <Esc> to exit.

User Activity Schedule

Select "Schedule" from the list and press <Enter>. A menu with the user activity settings for that specific user will open.

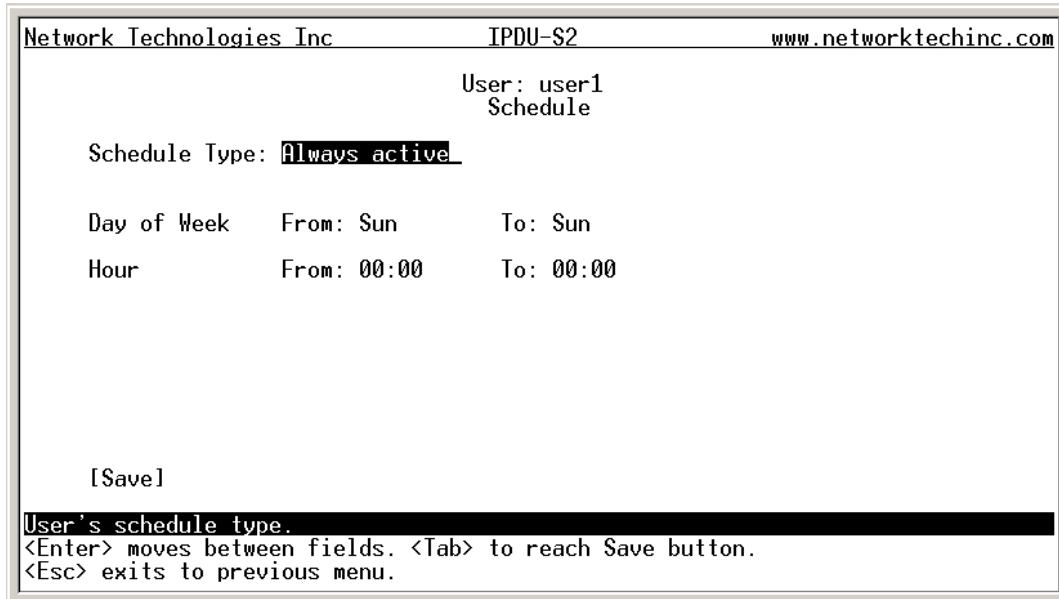

Figure 116- Text Menu-User Activity Schedule

Schedule Settings	
Schedule Type	Always active - user will receive messages at all hours of each day Active during defined times - user will only receive alert messages during times as outlined below
Day of Week-From:	First day of the week the user should begin receiving messages
Day of Week-To:	Last day of the week the user should receive messages
Hour From:	First hour of the day the user should begin receiving messages
Hour To:	Last hour of the day the user should receive messages

Security Configuration

The Security Configuration menu provides two submenus for setting local versus LDAP authentication methods and for applying IP filtering rules to prevent unwanted access to the IPDU-Sx.

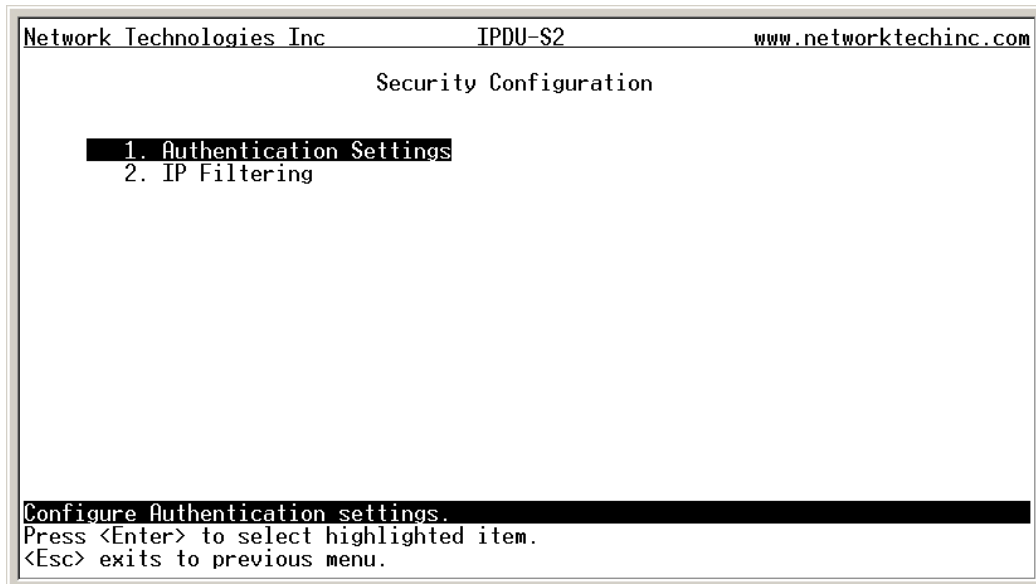

Figure 117- Text Menu-Security Configuration

Authentication Settings

Security in the IPDU-Sx can be managed one of two ways; through the local settings (passwords assigned in user settings on page 91) or through an LDAP server. If security is configured to use LDAP mode, then the passwords for users must be those found on a configured LDAP server.

Select "Authentication Settings" from the list and press <Enter>. A menu providing an option to either user Local authentication or LDAP mode. When in LDAP mode, usernames on the LDAP server must match those in the user settings of the IPDU-Sx or access will be denied.

Note: When the root user logs with the IPDU-Sx in LDAP mode, if the LDAP server is not responding, local authentication will be tried.

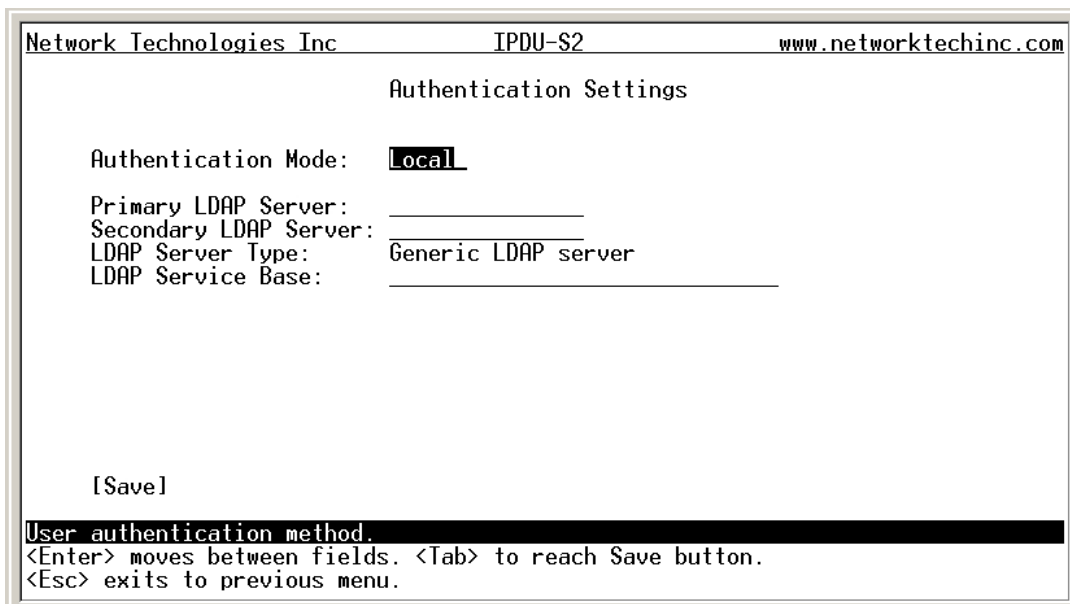

Figure 118- Text Menu-Authentication Settings

User Authentication	
Mode	Select Local to use authentication based on passwords in the IPDU-Sx user configuration Select LDAP to use authentication based on passwords in an LDAP server
Primary LDAP Server	Enter Hostname or IP address of Primary LDAP Server
Secondary LDAP Server	Enter Hostname or IP address of Secondary LDAP Server (optional)
LDAP Server Type	Tab to choose from the following: Generic LDAP server Novell Directory server Microsoft Active Directory
LDAP Service Base	Enter the Base DN for users (ex: ou=People,dc=mycompany,dc=com)

Even though LDAP authentication is being used, each user must also have a local account. User permission level is established by the local account.

Press <Tab> to highlight **Save** and press <Enter> to save before pressing <Esc> to exit.

IP Filtering

Included in the Security Configuration options is IP Filtering. IP Filtering provides an additional mechanism for securing the IPDU-Sx. Access to the IPDU-Sx network services (SNMP, HTTP(S), SSH, Telnet) can be controlled by allowing or disallowing connections from various IP addresses, subnets, or networks.

Up to 16 IP Filtering rules can be defined to protect the IPDU-Sx from unwanted access from intruders. Each rule can be set as Enabled or Disabled. Rules can be set to explicitly drop attempts to connect, or to accept them.

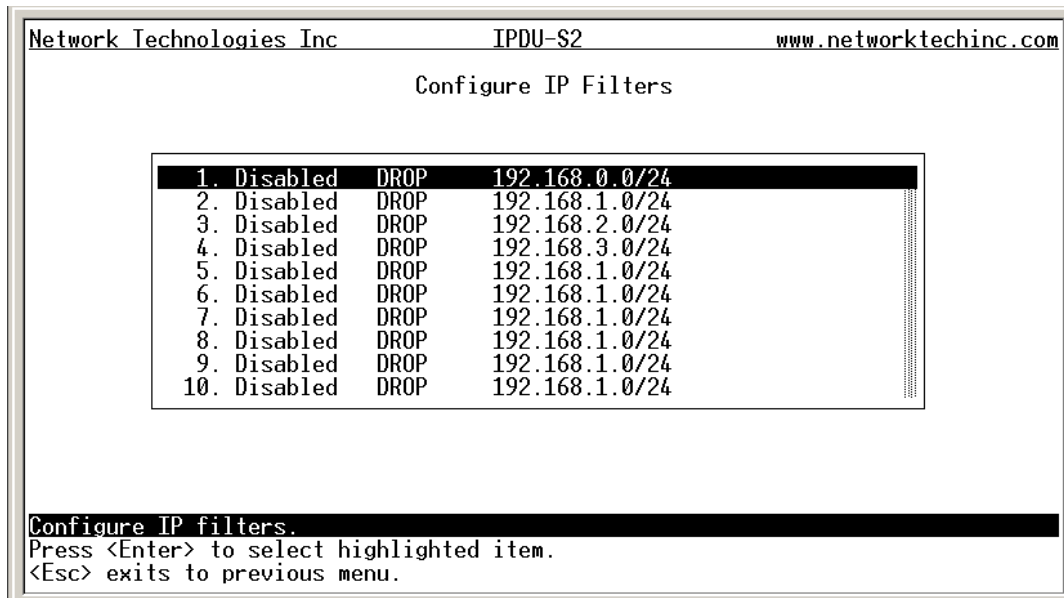

Figure 119- Text Menu-IP Filtering

To configure an IP Filter, select an IP Filter rule from the list and press <Enter>.

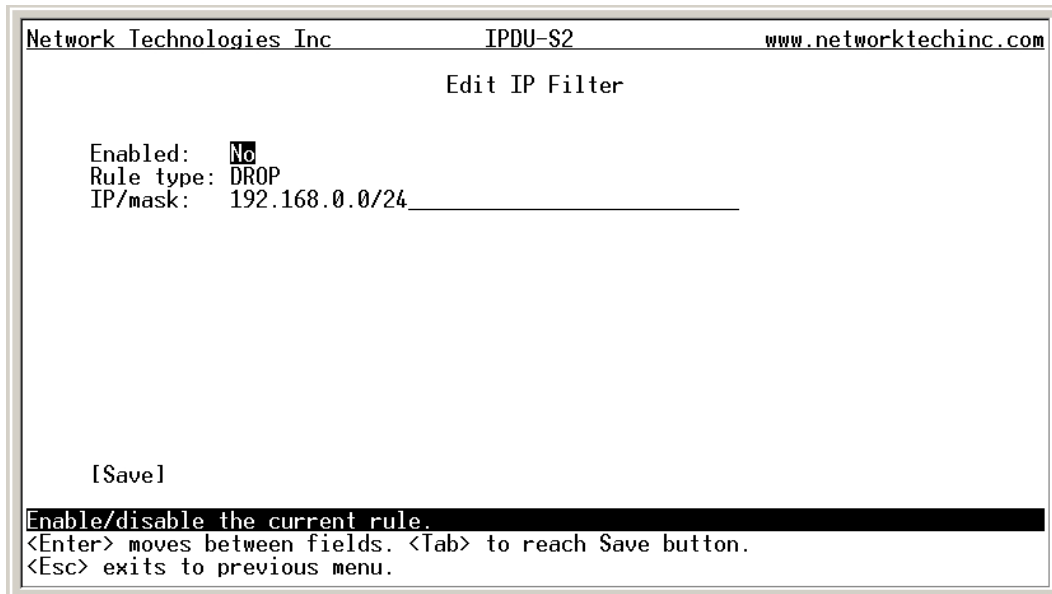

Figure 120- Text Menu-Configure IP Filter rule

The most common approach is to only allow “whitelisted” IP addresses, subnets, or networks to access the device while blocking all others. The IP Filters are processed sequentially from top to bottom, so it is important to place the most precise rules at the top of the list and the most generic rules at the bottom of the list.

As an example, assume we wish to block all connections except those which come from the IP address 192.168.1.100. To allow connections from 192.168.1.100, we need to configure and enable an ACCEPT rule at the top of the list:

(Rule 1)

```

Enabled: Yes
Rule type: ACCEPT
IP/mask:  192.168.1.100

```

Then, to block all other IP addresses from connecting to the IPDU-SX, we add a rule to drop all other connections.

(Rule 16)

```

Enabled: Yes
Rule type: DROP
IP/mask:  0.0.0.0/0

```

If the preceding “drop all connections” rule was placed in position one, no connections at all would be allowed to the unit. Remember: rules are processed from top to bottom. As soon as a rule matches, the processing stops and the matching rule is executed.

To match a particular IP address, simply enter in the desired IP address (e.g. 192.168.1.100).

To match a subnet, enter in the subnet with the associated mask (e.g. 192.168.1.0/24).

To match all IP address, specify a mask of 0 (e.g. 0.0.0.0/0).

Press <Tab> to highlight **Save** and press <Enter> to save before pressing <Esc> to exit.

Event and Data Logs

Under the Event and Data Logs menu find 4 submenus for viewing a log record of the events monitored by the IPDU-Sx and configuring how the IPDU-Sx will handle reaching the capacity of those logs.

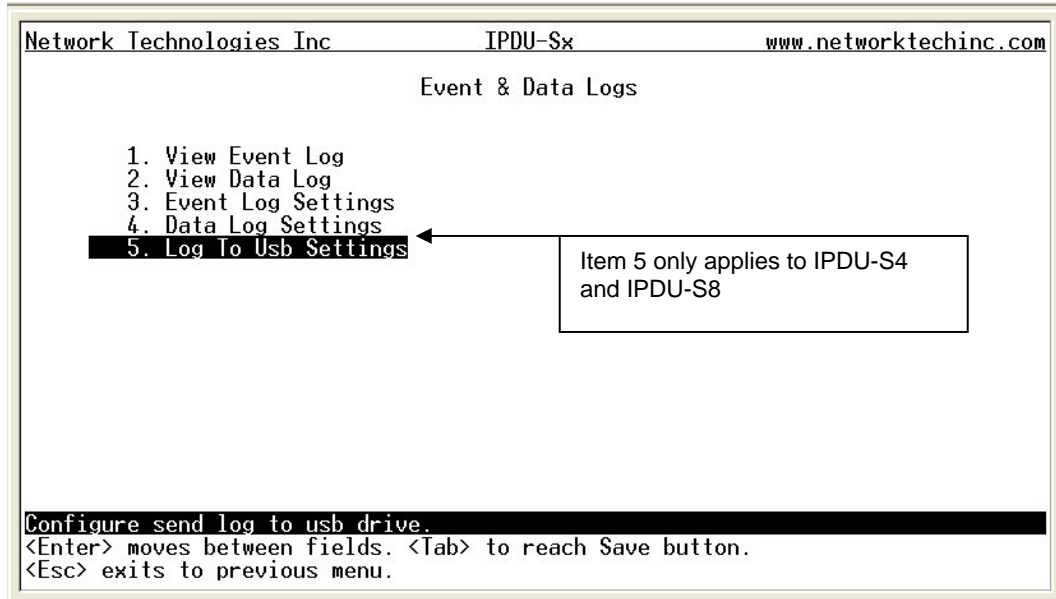

Figure 121- Text Menu-Event & Data Logs

View Event Log

The Event Log provides the administrative user with a listing of many events that occur within the IPDU-Sx. The event log will record the date and time of:

- each IPDU startup,
- each power outlet cycling,
- each user login and logout time,
- any time an unknown user tries to login,
- sensor and IP device alerts
- an alert handled by a user

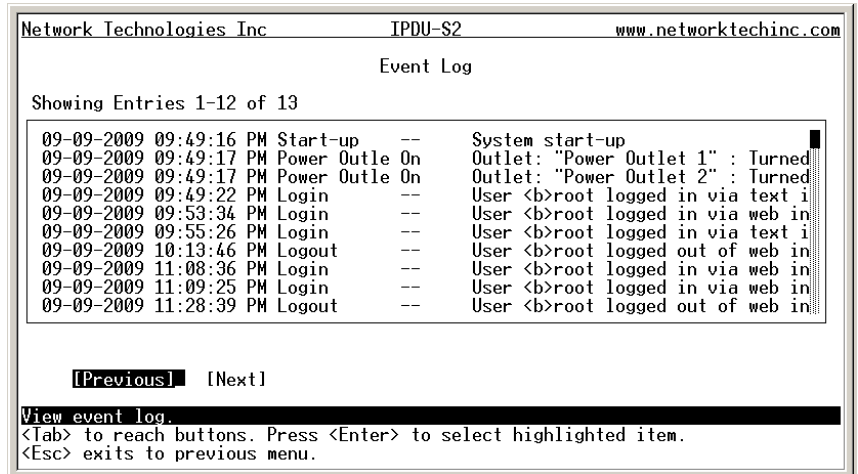

Figure 122- Text Menu-View Event Log

From the Event Log the administrative user can view the logs. In order to clear specific logs, download log entries, or clear the entire log, use the Web Interface (see page 53). To navigate between pages of logs, pres <Tab> to move between **Previous** and **Next** and press <Enter>.

View Data Log

The Data Log provides the administrative user with a listing of all the readings taken by the IPDU-Sx pertaining to the sensors and IP Devices being monitored. The data log will record the date and time of each reading.

```

Network Technologies Inc          IPDU-S2          www.networktechinc.com
                                Data Log
Showing Entries 1-5 of 5
09-10-2009 12:23:21 AM Humidity Co 36.4% Undefined #1
09-10-2009 12:23:31 AM Humidity Co 37.3% Undefined #1
09-10-2009 12:23:42 AM Humidity Co 36.4% Undefined #1
09-10-2009 12:23:49 AM Temperature 25.2C Undefined #1
09-10-2009 12:23:52 AM Humidity Co 37.3% Undefined #1

[Previous] [Next]
View data log.
<Tab> to reach buttons. Press <Enter> to select highlighted item.
<Esc> exits to previous menu.

```

Figure 123- Text Menu-View Data Log

From the Data Log the administrative user can view the logs. In order to clear specific logs, download log entries, or clear the entire log, use the Web Interface (see page 54). To navigate between pages of logs, press <Tab> to move between **Previous** and **Next** and press <Enter>.

Log Settings Menus

The Log Settings menus (Figure 124 and Figure 125) provide settings for how the IPDU-Sx will react when its Data and Event logs reach capacity.

Each log can be assigned to a group and any user that receives messages from that group can be notified when capacity is being reached.

As a capacity overflow action the log can be set to either :

- Discontinue- stop logging information
- Clear and restart- delete all log entries and restart with new entries
- Wrap- continue logging but delete the oldest entries and new ones are recorded

The Data and/or Event log can be set to send alerts to users via email, syslog, and/or SNMP traps once it has reached 90% of capacity, allowing them time to react.

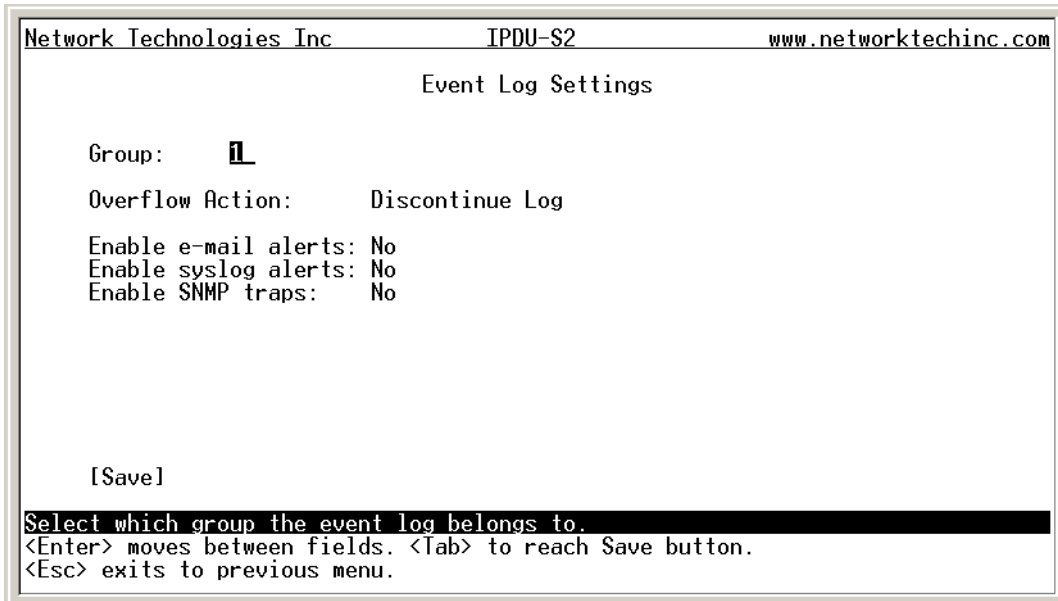

Figure 124- Text Menu-Event Log Settings

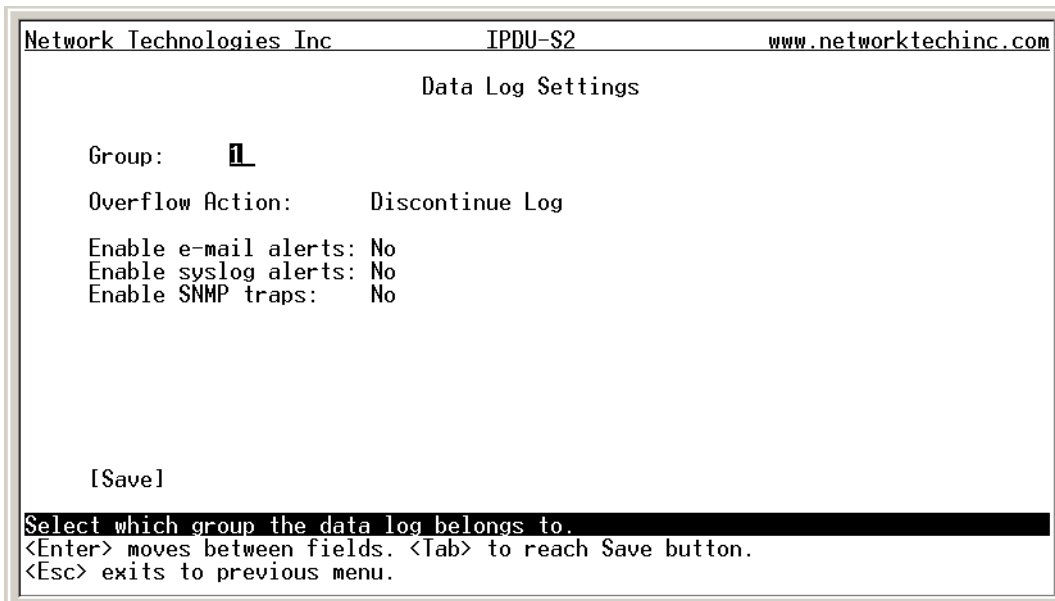

Figure 125-Text Menu-Data Log Settings

Log to USB

The USB Port found on the IPDU-S4 and IPDU-S8 enables the user to make the event and data log files portable. The IPDU-Sx will record event and data logs to a USB flash drive in addition to the internal IPDU-Sx memory when the feature is enabled. To use the USB port, carefully follow the steps below.

1. Place a USB flash drive in the USB port.
2. Toggle the “Enable Log to USB” option from “No” to “Yes”.
3. Press <Tab> to go to Save and press <Enter>.

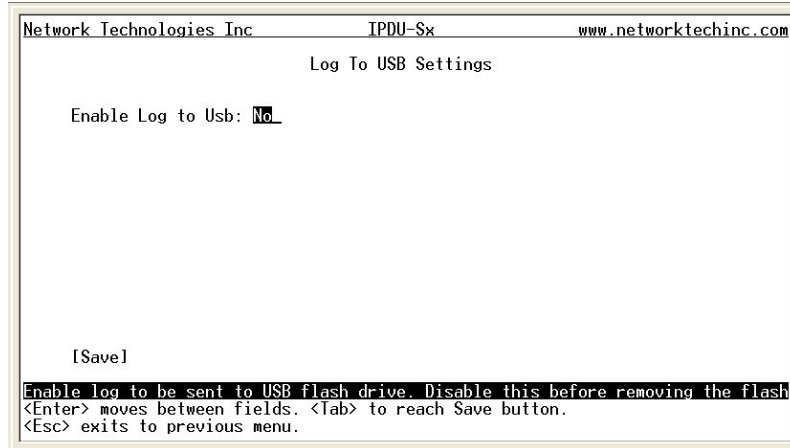

Figure 126- Enable Log to USB

Note: If the flash drive is not connected before enabling the feature, the IPDU-Sx will not recognize the flash drive.

4. The data and event logs will be recorded to both the USB flash drive and the IPDU-Sx internal memory.
5. **Toggle the “Enable Log to USB” option back to “No” before removing the flash drive from the USB port. Removing the flash drive before disabling the feature may cause any file(s) on flash drive to be corrupted.**

System Information

The System Information page lists current firmware, time, and network settings for the IPDU-Sx. It also lists the IPDU-SX MAC address.

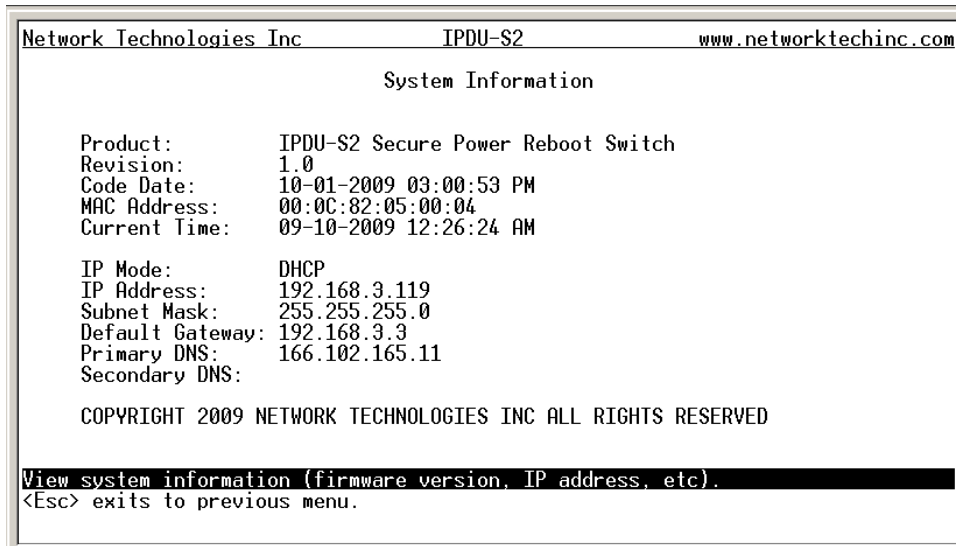

Figure 127-Text Menu-System Information

Reboot

From the Main Menu the administrative user can initiate a reboot of the IPDU-Sx. By highlighting "Reboot" and pressing <Enter> (or <9> and <Enter>), you will be prompted to confirm that you want to reboot the IPDU-Sx. Press <Enter> to cancel, or press the <Tab> or either <arrow> key to highlight "Yes" and <Enter> to reboot. The IPDU-Sx will reboot and a new connection must be initiated to reconnect, login, and resume operation.

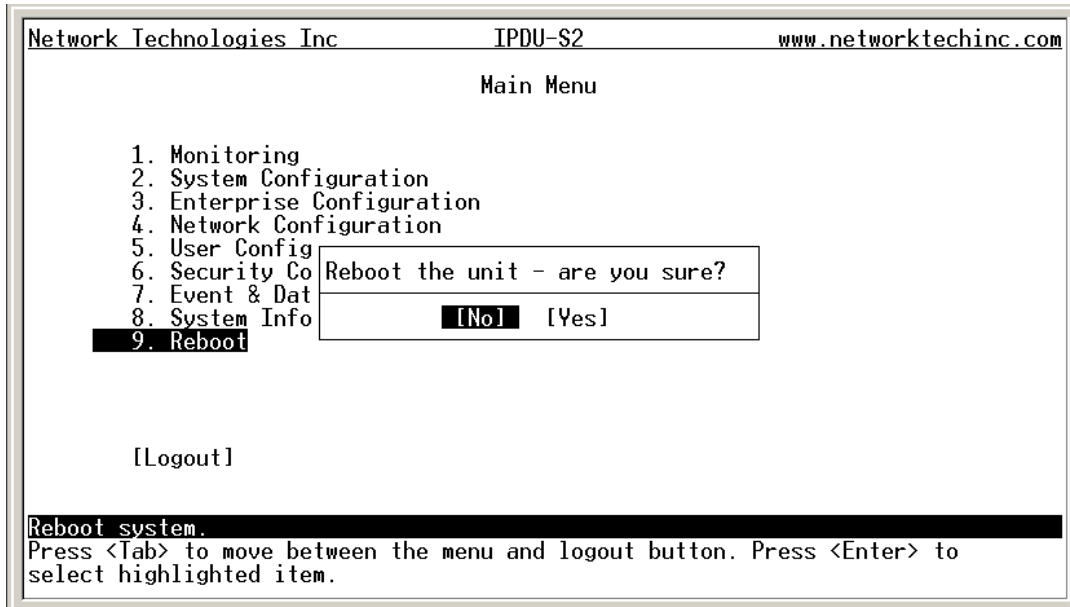

Figure 128- Text Menu-Reboot the IPDU-S2

Text Menu for Non-Administrative Users

Users without administrative privileges are able to view sensors, IP Devices, and power outlets and edit their own account settings.

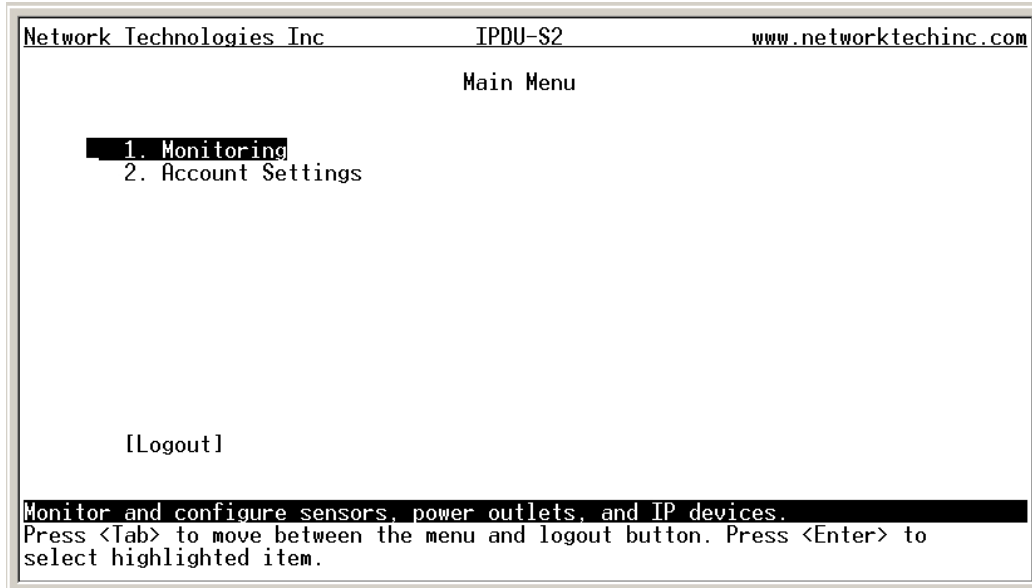

Figure 129- Text Menu-User Main Menu

Monitoring

The Monitoring menu lists 3 options for viewing the status of the items monitored by the IPDU-Sx.

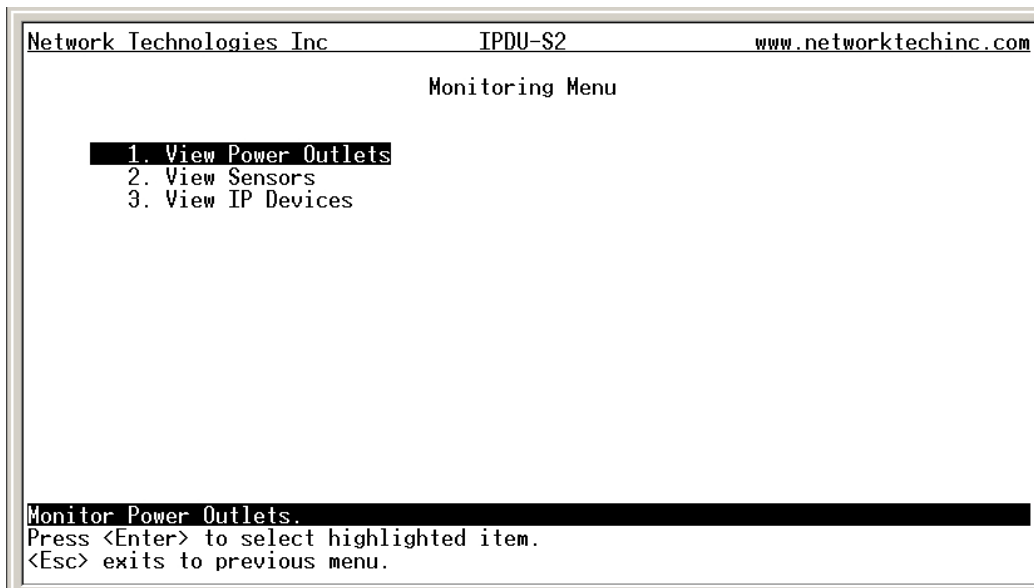

Figure 130-Text Menu-User Monitoring Menu

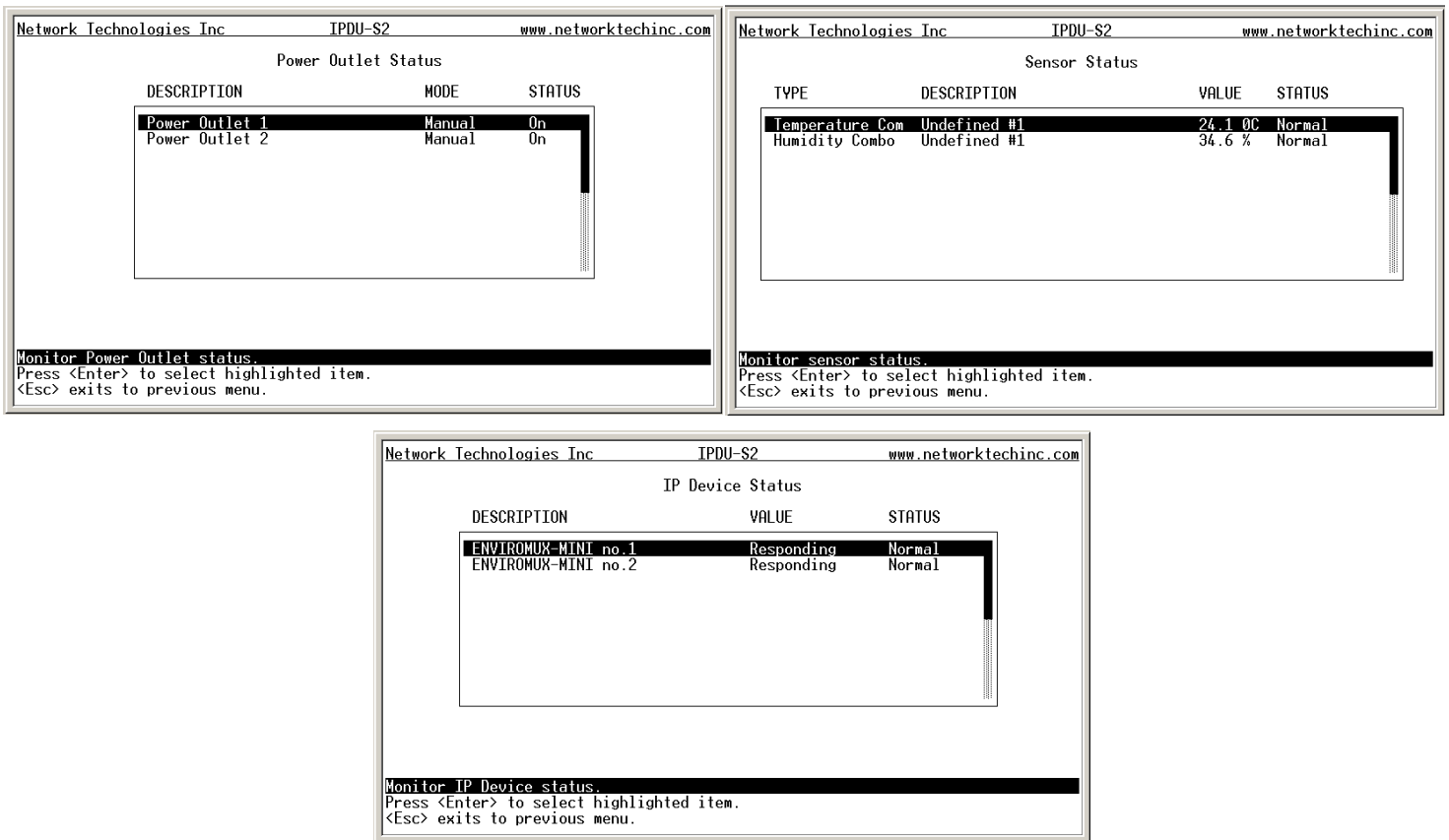

Figure 131- Text Menu-User accessible status menus

If a monitored item is in alert status, the non-administrative user can enter a response to it. By pressing the <Enter> key with the sensor selected, the user will have the option to either **acknowledge** the alert or **dismiss** it. If the user acknowledges the alert, no additional alert messages will be sent during that alert status cycle. If the user dismisses the alert, another alert message will be sent once the “notify again after” time designated on the configuration page (one example on page 23) elapses.

User Accessible Settings

The User without administrative privileges has access to setting for their own account.

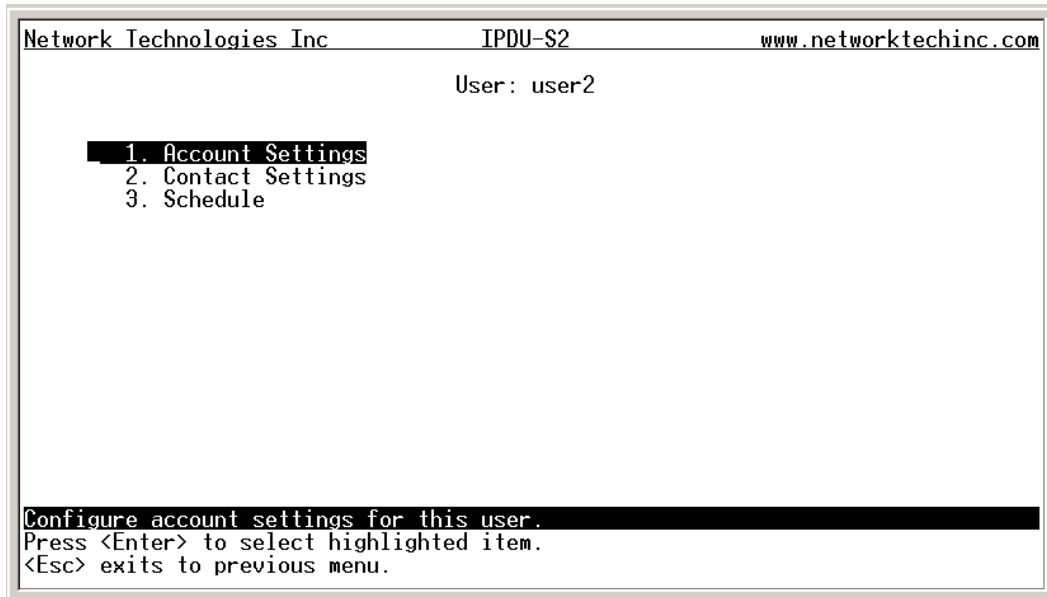

Figure 132- Text Menu-User Accessible Settings

Account Settings

Under Account Settings, the non-administrative user can edit their password, title, company, or department settings. Other settings are only accessible to the administrative user.

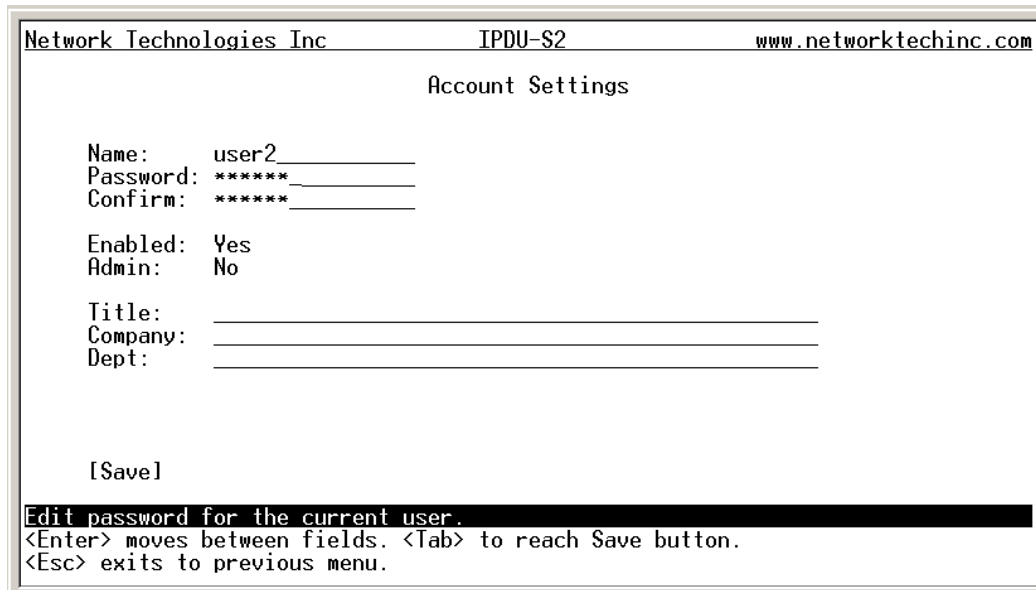

Figure 133- Text Menu-User Account Settings

Contact Settings

Under Contact Settings, the non-administrative user can decide which sensor group messages they will receive and how.

```

Network Technologies Inc          IPDU-Sx          www.networktechinc.com
                                User: user1
                                Contact Settings

Group 1: No
Group 2: No

Enable e-mail: No
E-mail Address: _____

Enable sms: No
Phone #: _____

Enable Syslog: No
Enable SNMP: No
Syslog/SNMP IP Address: _____

[Save]

User receives alerts for group 1.
<Enter> moves between fields. <Tab> to reach Save button.
<Esc> exits to previous menu.
    
```

Figure 134- Text Menu-User Contact Settings

Contact Settings	
Group 1	Change to “Yes” to receive messages from sensors, IP devices and outlets in Group 1
Group 2	Change to “Yes” to receive messages from sensors, IP devices and outlets in Group 2
Enable Email	Change to “Yes” to receive messages via email
Email address	Enter a valid email address to receive email alert messages
Syslog alerts	Change to “Yes” to receive alerts via syslog messages
SNMP traps	Change to “Yes” to receive alerts via SNMP traps
Syslog/SNMP IP address	Enter a valid syslog/SNMP IP address to receive syslog/SNMP messages

Press <Tab> to highlight **Save** and press <Enter> to save before pressing <Esc> to exit.

Schedule

Under Schedule, the non-administrative user can edit their activity schedule to control when messages should be sent to them.

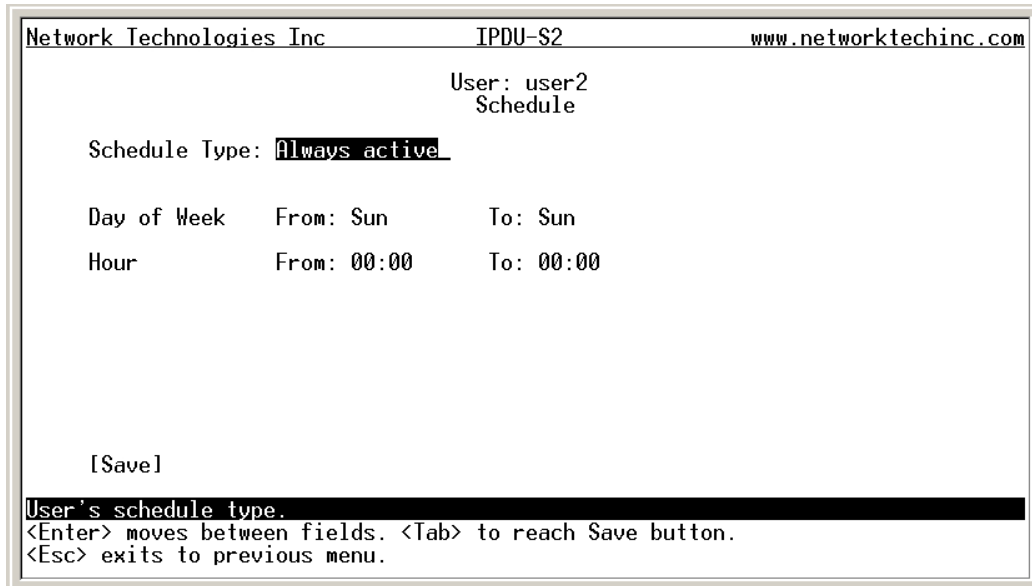

Figure 135- Text Menu-User Activity Schedule

Schedule Settings	
Schedule Type	Always active - user will receive messages at all hours of each day Active during defined times - user will only receive alert messages during times as outlined below
Day of Week-From:	First day of the week the user should begin receiving messages
Day of Week-To:	Last day of the week the user should receive messages
Hour From:	First hour of the day the user should begin receiving messages
Hour To:	Last hour of the day the user should receive messages

Press <Tab> to highlight **Save** and press <Enter> to save before pressing <Esc> to exit.

RESET BUTTON

A Reset push-button is on the front-panel and is recessed from the panel to prevent accidental use of the button. Pressing the Reset button will cause the IPDU-Sx to restart, just as if it were power-cycled. The Reset push-button has to be pressed and held for minimum of 7-10 seconds in order to activate the reset function. The reset button can be used at any time.

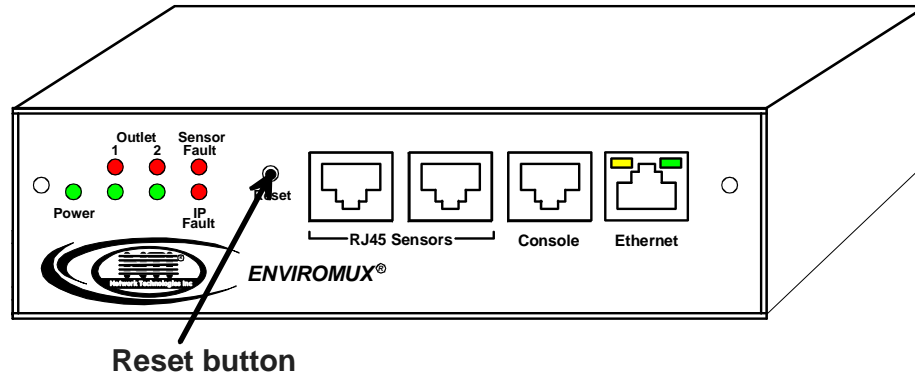

Figure 136- Location of Reset button

CIRCUIT BREAKER

The IPDU-S4-P15 and IPDU-S8-P15 are each equipped with a 15A circuit breaker (IPDU-S4-P10 and IPDU-S8-P10 have a 10A circuit breaker). The breaker offers protection against overloading the circuit supplying power to the connected devices. A red “Trip” LED is provided on the front of the unit (page 7) for visible indication of a tripped circuit breaker.

In the event the breaker trips (the reset button will extend from the body of the breaker), identify the cause of the overload before resetting the breaker. With a momentary push, the breaker should reset and the button snap back to its pre-trip position. If the button continues to extend from the breaker body, and it does not snap back to a reset after you press it (the “Trip” LED on the front of the IPDU will still be illuminated), the cause of the overload still exists.

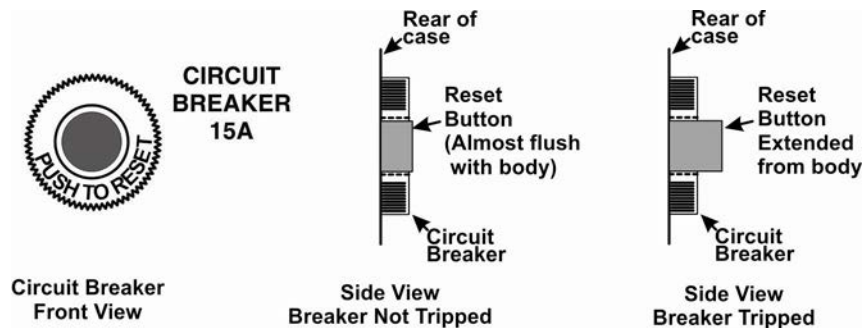

Figure 137- Circuit Breaker Protection

USB PORT

The IPDU-S4 and IPDU-S8 (-P10 and -P15) are each equipped with a USB Type A female port for connection of a USB flash drive or a GSM modem (page 8) for receiving alert messages via SMS. The port is compatible with USB 2.0 Full Speed flash drives. When enabled (page 55 and page 100) and with a USB flash drive connected, the Event and Data Logs will be written to a text file on the flash drive in addition to the memory in the IPDU.

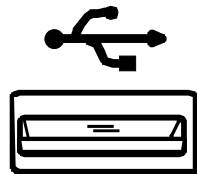

Figure 138- USB Flash Drive port

WIRING METHODS

PC-to IPDU-Sx Crossover Cable

In order to make a direct connection between a PC and the ETHERNET connector of the IPDU-Sx (all models), a crossover cable must be used. The cable is made with CAT5 cable terminated with RJ45 connectors and wired according to the chart below.

Pin assignment at Standard End	Wire Color	Pin assignment at Crossed End
1	White/Orange	3
2	Orange	6
3	White/Green	1
4	Blue	4
5	White/Blue	5
6	Green	2
7	White/Brown	7
8	Brown	8

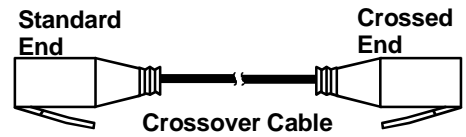
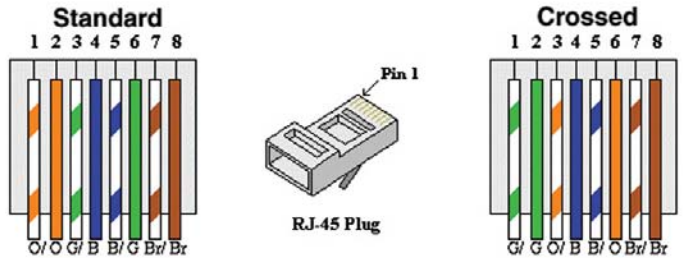

RS485 Sensor Cable

The CAT5 connection cable between the IPDU and the external RS485 Sensors (page 6) is terminated with RJ45 connectors and must be wired according to the EIA/TIA 568 B industry standard. Wiring is as per the table and drawing below.

Pin	Wire Color	Pair
1	White/Orange	2
2	Orange	2
3	White/Green	3
4	Blue	1
5	White/Blue	1
6	Green	3
7	White/Brown	4
8	Brown	4

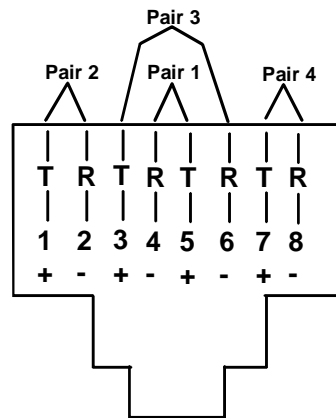

(View Looking into RJ45 Socket)

TECHNICAL SPECIFICATIONS

Sensor Inputs	Two RJ45 modular jacks for connecting NTI temperature, humidity, temperature/humidity, and liquid detection sensors.	
Ethernet Port	One female RJ45 connector with LEDs. 10 BaseT Ethernet interface.	
Console Port	One female RJ45 connector. Supports 3-wire interface (Tx, Rx, and GND)	
AC Outlet connectors	IEC 320-C13 10A @ 120/240VAC	
Maximum combined load on outlets	10A @ 120/240VAC (IPDU-S2, IPDU-S4-P10, IPDU-S8-P10) 15A @ 120/240VAC (IPDU-S4-P15, IPDU-S8-P15)	
USB Port (IPDU-S4/-S8 only)	USB Type A Female- USB 2.0 Full Speed compatible	
Compatible Sensor Types	Temperature, Humidity, Temp/Humidity, Temp/Wide Range Humidity, Liquid Detection	
Max. Sensor Cable Length	1000 feet	
Operating temperature- Standard Models Industrial Models (i.e. IPDU-S8-P15-OT3)	32°F to 122°F (0°C to 50°C) -40°F to 158°F (-40°C to 70°C)	
Storage temperature- Standard Models Industrial Models (i.e. IPDU-S8-P15-OT3)	-13°F to 149°F (-25°C to 65°C) -40°F to 185°F (-40°C to 85°C)	
Operating and Storage Relative Humidity	0 to 90% non-condensing RH	
Power	85-265VAC, 47-63Hz via Line Cord	
Protocols	HTTPS, SSHv2, SSLv3, IP Filtering, LDAPv3, AES 256-bit encryption, SNMPv2c	
Size (In.) WxDxH IPDU-S2 IPDU-S4-Pxx IPDU-S8-Pxx	6.1x5.6x1.7 13.5x6x1.75 w/o supplied Rackmount Kit 19x6x1.75 w/Rackmount Kit 17.4x6x1.75 w/o supplied Rackmount Kit 19x6x1.75 w/Rackmount Kit	
Approvals	RoHS	

TROUBLESHOOTING

Each and every piece of every product produced by Network Technologies Inc is 100% tested to exacting specifications. We make every effort to insure trouble-free installation and operation of our products. If problems are experienced while installing this product, please look over the troubleshooting chart below to see if perhaps we can answer any questions that arise. If the answer is not found in the chart, a solution may be found in the knowledgebase on our website at <http://information.networktechinc.com/jive/kbindex.jspa> or please call us directly at (800) 742-8324 (800-RGB-TECH) or (330) 562-7070 and we will be happy to assist in any way we can.

Problem	Cause	Solution
Cannot connect via telnet	telnet service not enabled	Enable telnet (page 33)
Terminal connection not working	connection settings not right	Check port configuration (page 6)
Cannot connect via web interface- no login screen	<ul style="list-style-type: none"> wrong IP address HTTP not enabled HTTP moved from default (port 80) 	<ul style="list-style-type: none"> Use Discovery Tool to locate configured IP address (page 13) Enable HTTP (page 33) Identify port number assigned (page 33)
Cannot get Discovery Tool to work	Java not installed	Java Runtime Environment must be installed before the Discovery Tool can be used (page 13)
LDAP user cannot login	Login username and/or password does not match same in IPDU-SX user list	Make sure the username and password used in the LDAP server matches the username and password in the IPDU-SX user configuration (page 43)
Cannot login	cannot remember root password	Either restore default settings (page 78) or contact NTI for assistance
Cannot change state of output relays through SNMP (applies to IPDU-S4/S8 only)	<ul style="list-style-type: none"> “Read-Only Community Name” and “Read-Write Community Name” fields are different in the IPDU configuration from what they are in the SNMP network management software Old MIB file being used Firmware outdated 	<ul style="list-style-type: none"> The “Read-Only Community Name” in the IPDU network configuration (page 33) should match the same/similar field in the SNMP network management software and the “Read-Write Community Name” in the IPDU should also match the same/similar field in the SNMP software Download and install MIB file version 1.01 or later Download and install Firmware version 1.3 or later

HOW TO CREATE AN X.509 CERTIFICATE FOR ENVIROMUX

The ENVIROMUX family of products are designed to be configurable with security to limit access to their web interface controls. The use of x.509 client authentication is one of the methods that may be used, and although the ENVIROMUX includes a default x.509 CA certificate (page 47), this procedure will help you create your own custom x.509 CA certificate to use with this feature. This procedure was created using Ubuntu Linux and OpenSSL (a requirement for creating the certificate).

Note: Do not disable access to the ENVIROMUX web interface using http before you verify that the https client authentication works properly (see page 118).

Creating a Certificate Authority using OpenSSL

The Root CA certificate will be used by a web server (ENVIROMUX) to authenticate the client (browser). It also needs to be imported in a web browser as a Trusting authority.

An example SSL config file (openssl.cnf) can be found at <http://www.networktechinc.com/environment-monitor-16d.html#tab-6> . (You can edit it in any text editor to customize for your own needs.)

Creating the Certificate Management Directories and Files

1. Create directory "ntiCA" in /usr/local/ssl for ntiCA certificate management and change to that directory. ("nti" can be changed to whatever you want throughout this procedure, but do it consistently. Whatever you change it to, make sure the openssl.cnf file is edited to match your changes)

```
mkdir /usr/local/ssl/ntiCA
cd /usr/local/ssl/ntiCA
```

Create following directories in the ntiCA directory:

```
mkdir CA
mkdir server
mkdir server/certificates
mkdir server/requests
mkdir server/keys
mkdir user
mkdir user/certificates
mkdir user/requests
mkdir user/keys
```

The CA directory will be populated with the certificate authority certificate request, keys and certificate used to sign server and user certificates. The server directory hierarchy will be used to manage certificate requests, keys and certificates issued for web server hosts. The user directory hierarchy will be used to manage certificate requests, keys and certificates for users.

2. Issue the following commands to setup default contents of certificates and revocation list for these files:

(The percent sign (%) is the command prompt, not part of the command.)

```
% cd /usr/local/ssl/ntiCA
% echo "01" > serial
% touch index.txt
```

The openssl.cnf file that you edited earlier (if you did) references these files so make sure they are created in the ntiCA directory.

Creating the ntiCA Key and Certificate

The general process for creating a certificate includes:

1. Creating a private key
2. Creating a certificate request
3. Creating and signing a certificate from the certificate request

1. Create the CA key:

```
% cd /usr/local/ssl/ntiCA
% openssl genrsa -out ./CA/ntiCA.key 2048
Generating RSA private key, 2048 bit long modulus
.....+++++
.....+++++
e is 65537 (0x10001)
```

Recommended for hi level of security

2. Create the CA certificate request:

```
% openssl req -sha512 -new -key ./CA/ntiCA.key -out ./CA/ntiCA.csr
```

You are about to be asked to enter information that will be incorporated into your certificate request.

What you are about to enter is what is called a **Distinguished Name** or a DN.

There are quite a few fields but you can leave some blank

For some fields there will be a default value,

If you enter '.', the field will be left blank.

```
Country Name (2 letter code) [US]:
State or Province Name (full name) [OH]:
Locality Name (eg, city) [Aurora]:
Organization Name (eg, company) [NTI]:
Organizational Unit Name (eg, section) []:
Common Name (eg, YOUR name) []:your_user_name
Email Address [sales@ntigo.com]:
```

```
Please enter the following 'extra' attributes
to be sent with your certificate request
```

```
A challenge password []:password
```

```
An optional company name []:
```

3. Self-sign the CA certificate:

```
% openssl x509 -req -sha512 -days 3650 -in ./CA/ntiCA.csr -out ./CA/ntiCA.crt -signkey
./CA/ntiCA.key
Signature ok
Getting Private key
```

Verifying the CA certificate contents

At this point we have our self-signed CA certificate and our CA key, which will be used to sign the web server and client certificates that we create. To verify the certificate contents, use the following command:

```
% openssl x509 -in ./CA/ntiCA.crt -text
```

Creating a Web Server Certificate (This will need to be done for each web server)

The procedure for creating a web server certificate is similar to that for creating the CA certificate except that the web server certificate will be signed using the CA key rather than self-signing with a web server-specific key.

1. Create the web server private key using a fully qualified DNS name (or IP address). When prompted for the pass phrase, **enter a password that you can remember**.

```
% cd /usr/local/ssl/ntiCA
% openssl genrsa -des3 -out ./server/keys/your_device_fqdn_or_ipaddress.key 2048
Generating RSA private key, 2048 bit long modulus
.....++++++
.++++++
e is 65537 (0x10001)
Enter pass phrase for ./server/keys/your_device_fqdn_or_ipaddress.key:
Verifying - Enter pass phrase for ./server/keys/your_device_fqdn_or_ipaddress.key:
```

2. Create the web server certificate request using the same fully qualified DNS name (or IP address) you used for the private key. When prompted for the pass phrase for the keys in file ./server/keys/your_device_fqdn_or_ipaddress.key, enter the pass phrase that you used for the private key. Also, **it is vitally important** that you set the Common Name value to the fully qualified DNS name of your web server because that's the value that a browser client will verify when it receives the web server's certificate.

```
% openssl req -sha512 -new -key ./server/keys/your_device_fqdn_or_ipaddress.key -out
./server/requests/your_device_fqdn_or_ipaddress.csr
Enter pass phrase for ./server/keys/your_device_fqdn_or_ipaddress.key:
```

You are about to be asked to enter information that will be incorporated into your certificate request.

What you are about to enter is what is called a **Distinguished Name** or a DN.

There are quite a few fields but you can leave some blank

For some fields there will be a default value,

If you enter '.', the field will be left blank.

```
Country Name (2 letter code) [US]:
State or Province Name (full name) [OH]:
Locality Name (eg, city) [Aurora]:
Organization Name (eg, company) [NTI]:
Organizational Unit Name (eg, section) []:
Common Name (eg, YOUR name) []:your_device_fqdn_or_ipaddress
Email Address [ca@ntigo.com]:sales@ntigo.com
```

Please enter the following 'extra' attributes

to be sent with your certificate request

A challenge password []:

An optional company name []:

3. Sign the web server certificate with the CA key:

```
% openssl ca -days 3650 -in server/requests/your_device_fqdn_or_ipaddress.csr -cert
./CA/ntiCA.crt -keyfile ./CA/ntiCA.key -out
./server/certificates/your_device_fqdn_or_ipaddress.crt -config <path_to_config
file>\openssl.cnf
```

In the command above, substitute the path to the config file "openssl.cnf" in place of "<path_to_config_file>".

```
DEBUG[load_index]: unique_subject = "yes"
  Check that the request matches the signature
  Signature OK
  Certificate Details:
  Serial Number: 3 (0x3)
  Validity
  Not Before: Aug 18 17:41:07 2005 GMT
  Not After : Aug 18 17:41:07 2006 GMT
  Subject:
  countryName = US
  stateOrProvinceName = OH
  organizationName = NTI
  commonName = your_device_fqdn_or_ipaddress
  emailAddress = sales@ntigo.com
  X509v3 extensions:
  X509v3 Basic Constraints:
  CA:FALSE
  Netscape Comment:
  OpenSSL Generated Certificate
  X509v3 Subject Key Identifier:
  0A:6B:79:E7:98:5F:30:7F:A0:67:4A:12:83:9C:0A:58:BE:8B:41:2A
  X509v3 Authority Key Identifier:
  DirName:/C=US/ST=OH/L=Aurora/O=NTI /CN=NTI CA/emailAddress=sales@ntigo.com
  serial:CD:93:0B:9F:5A:71:EB:8B

  Certificate is to be certified until Aug 18 17:41:07 2026 GMT (365 days)
  Sign the certificate? [y/n]:y

  1 out of 1 certificate requests certified, commit? [y/n]y
  Write out database with 1 new entries
  Data Base Updated
```

To verify the web server certificate contents, use the following command:

```
% openssl x509 -in ./server/certificates/your_device_fqdn_or_ipaddress.crt -text
```

Key values to look for are:

```
Subject CN=your_device_fqdn_or_ipaddress
Issuer CN=NTI CA
```

Uploading Server Certificate to NTI device

The NTI ENVIROMUX webservice expects the certificate and key as a single file in "PEM" format.

Note: If your key has a password then you need to create a key without password.

Use the following command to export the file without the password.
`openssl rsa -in <your_key>.key -text > private.key`

Use following command to create pem certificate file
`cat <your_certificate_name>.cert private.key > <server_name>.pem`

On the ENVIROMUX WEB Interface menu Under "Administration" select "Security".
 In X509 certificates

Select the above file and press the button "**Upload Server certificate and Key**"

<your_key> , <your_certificate_name>
 and <server_name> are placeholders.
 "Your_certificate" is the web server
 certificate you created, "your_key" is the
 CA key you created, and the "server_
 name" is whatever you want the pem file
 to be named.

Creating a Client Certificate

The procedure for creating a client certificate is similar to that for creating the web server certificate.

Creating a user key

The following instructions create a private key for a user named your_name@ntigo.com. When prompted for the pass phrase, enter a password that you can remember.

```
% cd /usr/local/ssl/ntiCA
% openssl genrsa -des3 -out ./user/keys/your_name@ntigo.com.key 2048
Generating RSA private key, 2038 bit long modulus
...+++++
.....+++++
e is 65537 (0x10001)
Enter pass phrase for ./user/keys/your_name@ntigo.com.key:
Verifying - Enter pass phrase for ./user/keys/your_name@ntigo.com.key:
```

Create the user certificate request

1. The following command creates a certificate request for a user with email address: your_name@ntigo.com and common name your_name. When prompted for the pass phrase for the keys in file ./user/keys/your_name@ntigo.com.key, enter the pass phrase that you used to create the user key (e.g. "password").

```
% openssl req -sha512 -new -key ./user/keys/your_name@ntigo.com.key -out
./user/requests/your_name@ntigo.com.csr
Enter pass phrase for ./user/keys/your_name@ntigo.com.key:
```

You are about to be asked to enter information that will be incorporated into your certificate request.

What you are about to enter is what is called a **Distinguished Name** or a DN.

There are quite a few fields but you can leave some blank

For some fields there will be a default value,

If you enter '.', the field will be left blank.

```
-----
Country Name (2 letter code) [US]:
State or Province Name (full name) [OH]:
Locality Name (eg, city) [Aurora]:
Organization Name (eg, company) [NTI]:
Organizational Unit Name (eg, section) []:
```

```
Common Name (eg, YOUR name) []:your_name
Email Address [ca@ntigo.com]:your_name@ntigo.com
```

Please enter the following 'extra' attributes
to be sent with your certificate request

```
A challenge password []:
An optional company name []:
```

2. Sign the user certificate request and create the certificate

```
% openssl ca -in ./user/requests/your_name@ntigo.com.csr -cert ./CA/ntiCA.crt -keyfile
./CA/ntiCA.key -out ./user/certificates/your_name@ntigo.com.crt
```

Using configuration from /usr/local/ssl/openssl.cnf

```
DEBUG[load_index]: unique_subject = "yes"
```

3. Check that the request matches the signature

```
Signature OK
Certificate Details:
Serial Number: 4 (0x4)
Validity
Not Before: -----
Not After : -----
Subject:
countryName = US
stateOrProvinceName = OH
organizationName = NTI
commonName = your_name
emailAddress = your_name@ntigo.com
X509v3 extensions:
X509v3 Basic Constraints:
CA:FALSE
Netscape Comment:
OpenSSL Generated Certificate
X509v3 Subject Key Identifier:
-----
X509v3 Authority Key Identifier:
DirName:/C=US/ST=OH/L=Aurora/O=NTI/CN=your_nameCA/emailAddress=sales@ntigo.com
serial:CD:93:0B:9F:5A:71:EB:8B
----
Sign the certificate? [y/n]:y

1 out of 1 certificate requests certified, commit? [y/n]y
Write out database with 1 new entries
Data Base Updated
```

Verifying the user certificate contents

To verify the user certificate contents, you can use the following command:

```
% openssl x509 -in ./user/certificates/your_name@ntigo.com.crt -text
```

Importing a Client Certificate into Web Browsers

Web browsers like Firefox and IE can't use the certificates in the PEM format that is generated by OpenSSL . Consequently, we'll need to export the user certificate to file formats that can be imported by web browsers.

Importing the client certificate in PKCS#12 format

Firefox and Internet Explorer 6.0 support the PKCS#12 certificate format. Use the following command to convert the user certificate to this format.

NOTE: During the conversion process, you'll be asked for an export password. Enter anything you can remember, but don't let it be empty because the file will contain your private key.

```
% openssl pkcs12 -export -clcerts -in ./user/certificates/your_name@ntigo.com.crt -inkey
./user/keys/your_name@ntigo.com.key -out ./user/certificates/your_name@ntigo.com.p12
```

Copy the your_name@ntigo.com.p12 file to a location where you can access it from your web browser via the file system.

Import Using Internet Explorer 6.0

To import a certificate, start IE and follow the instructions below:

- Navigate to the Tools menu and click Internet Options

- Click the Content tab

- Click the Certificates button

- Click the Import button

- Follow the wizard instructions to select the certificate file

- Enter the password you used to protect your certificate and private key

- Import client certificates into the Personal store and root certificates for the CA that signed the web server certificates into the Trusted Root Certification Authorities store

- Click the imported certificate and then on the View button in the Certificate intended purposes group box. Click the Details tab and then the Edit Properties button. Make sure that the Client Authentication option is checked.

For more detailed information, please see Microsoft Internet Explorer 6 Resource Kit, Chapter 6 - Digital Certificates.

Import using FireFox 1.5

To import a certificate, start FireFox and follow the instructions below:

- Navigate to the Tools menu and click Options

- Click the Advanced icon

- Click the Security tab

- Click the View Certificates button

- Click the Import button and select the certificate file

- Enter your master password for the Software Security Device

- Enter the password you used to protect your certificate and private key

Importing the nti CA root certificate into web browsers

In order to establish a chain of trust between the imported user certificate and the issuing certificate authority, you'll need to import the nti CA certificate into your web browser.

Though the user interface for accepting the CA certificate varies, it is possible to import it for Firefox and IE 6.0 in this way.

Firefox 1.5

A dialog box appears and offers the choice of importing the CA certificate. Select the "Trust this CA" to identify web sites option, then click the "OK" button. You may also select the "View" button to see the certificate contents before accepting it.

Internet Explorer 6.0

A dialog box appears and asks "Do you want to open or save this file?". Select the "Open" option, then click the "Install Certificate" button when the certificate dialog appears.

Once you've successfully imported the nti CA you will be able to access the URL of the ENVIROMUX without being prompted to accept the web server certificate.

Configuring NTI device to require Client Certificate

On the ENVIROMUX WEB Interface menu Under "Administration" select "Security".

In X509 certificates select the file `ntiCA.crt` and press button "Upload CA certificate"

To enable the device to ask for client certificate select "certificate + login" in the "Mode" field under "User Authentication".

Use https communication.

Note: Before disabling http be sure to verify https client authentication works properly.

Server Settings	
Enable Telnet	<input type="checkbox"/> Enable access to this device via telnet
Enable SSH	<input checked="" type="checkbox"/> Enable access to this device via ssh
Enable HTTP Access	<input checked="" type="checkbox"/> Enable access to this device via standard (non-secure) HTTP requests. HTTPS is always enabled.
HTTP Port	80 Port for standard HTTP requests
HTTPS Port	443 Port for HTTPS requests
Web Timeout	20 Minutes after which idle web users will be logged out (0 disables idle logout)

Save

Server settings section of Network configuration from ENVIROMUX web interface

INDEX

- acknowledge, 16, 29, 62, 63, 103
- Administration**, 30, 53
- authentication, 94
- cable connections, 5
- cascade notification, 42, 89
- cascaded installation, 8
- cascading-text menu**, 38, 85
- circuit breaker, 107
- configure events, 28
- console port connect, 58
- crossover cable, 108
- data log-view, 54, 98
- default IP address, 14
- Device Discovery Tool, 13
- DHCP server**, 33
- Direct Connect, 8
- dismiss, 16, 29, 62, 63, 103
- downloads, 57
- enable USB port, 55
- enterprise configuration, 32, 79
- Ethernet connection, 5
- event and data logs, 97
- event log-view, 53, 97
- event monitor, 28
- features, 1, 3
- firmware update-web, 51
- flash drive, 107
- groups, 19
- GSM modem, 8, 11, 32
- HTTP Server Port, 35, 83
- IP Aliases, 36, 84
- IP devices-configure, 26, 73
- IP devices-monitor, 25
- IP devices-view, 63
- IP filtering, 49, 95
- Java Runtime Environment, 13
- LDAP mode, 47
- LEDs-front panel**, 7
- log in, 14
- log settings, 98
- log settings-configure, 54
- login-web interface, 14
- monitoring-text menu, 61
- monitoring-web interface, 15
- Network configuration, 79
- Network Configuration**, 33
- operating modes**, 19
- overview, 10
- Password**, 14
- port number, 35, 83
- power outlet-configuration, 17, 64
- power outlets-view, 62
- reboot, 101
- reboot, 52
- reset button, 107
- restore defaults, 78
- security, 47
- security configuration, 94
- sensor attachment, 6
- sensors-configure**, 22, 67
- sensors-view, 62
- service settings, 83
- SMS alert messages, 8
- SMTP server, 35, 80
- SNMP-control outputs**, 35
- SNTP server, 31
- SSH, 59
- Summary page**, 15
- system configuration, 30, 77
- system information, 50, 100
- Telnet, 59
- terminal, 6
- text menu navigation, 61
- text menu-login**, 58
- text menu-non-admin, 102
- threshold, 24, 69
- time settings, 77
- troubleshooting, 110
- USB port, 107
- user configuration, 43, 90
- username and password, 14
- web browsers supported, 2
- X509 certificate**, 48
- X509 certificate, create, 111

WARRANTY INFORMATION

The warranty period on this product (parts and labor) is two (2) years from the date of purchase. Please contact Network Technologies Inc at **(800) 742-8324** (800-RGB-TECH) or **(330) 562-7070** or visit our website at <http://www.networktechinc.com> for information regarding repairs and/or returns. A return authorization number is required for all repairs/returns.

MAN119 Rev. 5/22/20