



PWR-RMT-RBT2-515R-LCV2

2-Port Remote Power Reboot Switch

USER MANUAL



Table of Contents

Chapter 1: Introduction	3
1.1. Introduction.....	3
1.2. Hardware Specification	4
1.3. Network Diagram.....	5
1.4. LED Indicators Explained	6
Chapter 2: Hardware Setup	8
Chapter 3: Software & Web Setup	9
3.1. Introduction.....	9
3.2. How to Locate & Access IP Switch in LAN	9
3.2.1 Locate IP Switch in LAN using Utility program.....	9
3.2.2 Locate IP Switch in LAN using fixed IP	10
3.3. How to Access IP Switch from WAN – using DDNS	11
3.4. How to Access IP Switch from WAN - using Hangouts	11
3.4.1. How to Setup Hangouts.....	12
3.4.2. How to Control IP Switch using Hangouts.....	13
3.5. How to Access IP Switch from WAN – Using Skype.....	14
3.6. How to Access IP Switch from Mobile App	16
3.7. How to Upgrade/ Re-Flash Firmware.....	18
Chapter 4: IP Switch Web User Interface	19
4.1. Information.....	19
4.1.1 Current Status.....	19
4.2 Configuration	20
4.2.1 Configuration.....	21
4.2.2 Schedule	24
4.2.3 Network.....	24
4.2.4 E-mail	28
4.2.5 Account.....	29
4.2.6 Hangouts.....	30
4.2.7 System Time.....	31
4.2.8 Language.....	33
4.2.9 SMS.....	33
4.3 Log Information	33
4.3.1 Event Log	33
4.4 Help	34
4.4.1 System Status.....	34
4.4.2 Save / Upgrade.....	34
Chapter 5: Troubleshooting Tips	36
5.1 Common Issues	36
5.2 Hangouts	39
5.2.1 Using Accounts with 2-Step Verification.....	41

Chapter 1: Introduction

1.1. Introduction

PWR-RMT-RBT2-515R-LCV2 (IP Switch) is designed to automatically power-cycle *either* one or both of its outlets when either;

- a) Internet connectivity is lost, OR
- b) the network device being monitored is no longer responding in LAN.

It can also be used to:

- a) remotely control outlets via instant messaging tools like Google Hangouts and Skype, via cloud management, or via its web user interface.
- b) perform scheduled power On / Off / Reset
- c) manually control outlets by disabling the UIS (Uninterruptable Internet System) function

IP Switch is useful where the Internet connection and accessibility to a remote site is critical. It can be setup so that when the remote Mobile Broadband / Cable / Satellite / DSL / T1, etc. connection drops or if the remote router freezes-up, it will auto reset the router to re-gain connectivity. IP Switch is also useful for:

1. Saving home users the trouble of constantly having to power-cycle their router to re-gain Internet connectivity.
2. Resetting unresponsive device (e.g. IP camera or NAS servers) which otherwise will be inaccessible from remote.
3. IT Professionals who need to automatically or remotely reset devices
4. Preventing your connection from timing out or going dormant
5. Having devices on an automatic power schedule

Generalized description of network connection:

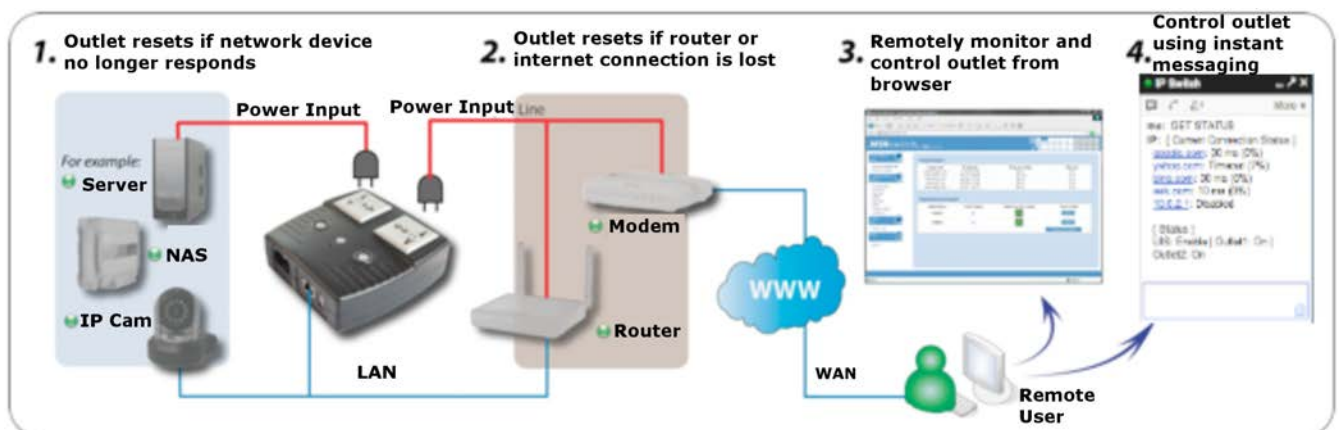

Hardware Specifications:

1. Built-in Web Server with 32-Bit RISC CPU.
2. 10/100Mbps Fast Ethernet Network Access.
3. Support IE or Java-Enabled Web Browser.

4. Network Protocol: HTTP, TCP/IP, UDP, SMTP, Dynamic DNS, DNS Client, SNTP, DHCP, HTTPS (TLS1.2).
5. Operating Temperature: 0°C ~ 60°C; Operating Humidity: 10% ~ 90%
6. For indoor use only.

1.2. Hardware Specification

NTI No:	PWR-RMT-RBT2-515R-LCV2
Socket type	2x NEMA 5-15R (Type B)
Certifications	FCC
Electrical Rating	Input: 120~250V~50/60Hz Output: 10A (2 sockets combined)
Fuse Type	10A (Thermal fuse). Spare fuse at bottom of case
Available Sockets	2x fixed
Outlet On/ Off Button	2x button with Orange LED (press & hold 2 seconds to toggle)
UIS On/ Off Button	1 button with Blue LED (press & hold to toggle)
Other LED Indicator	1x Green for Internet Indicator 1x Green for Cloud Link Indicator
Reset to Factory Default	Press & hold Outlets 1 & 2 for 10 seconds, then release
Internet Indicator	Green LED
Web Server CPU	32-Bit RISC CPU
RTC	Built-in Real-Time Clock
Supported browser	IE and Java
Supported Network Protocols	HTTP, HTTPS(TLS1.2), TCP/IP, UDP, SMTP, Dynamic DNS, DNS Client, SNTP, DHCP
LAN Port	1x RJ45, 10/100 Base-T
Operating Environment	0°C to 60°C at 10% ~ 90% relative humidity. Designed for indoor use only.
Power Cable	1.0 meter with NEMA 5R15 plug

1.3. Network Diagram

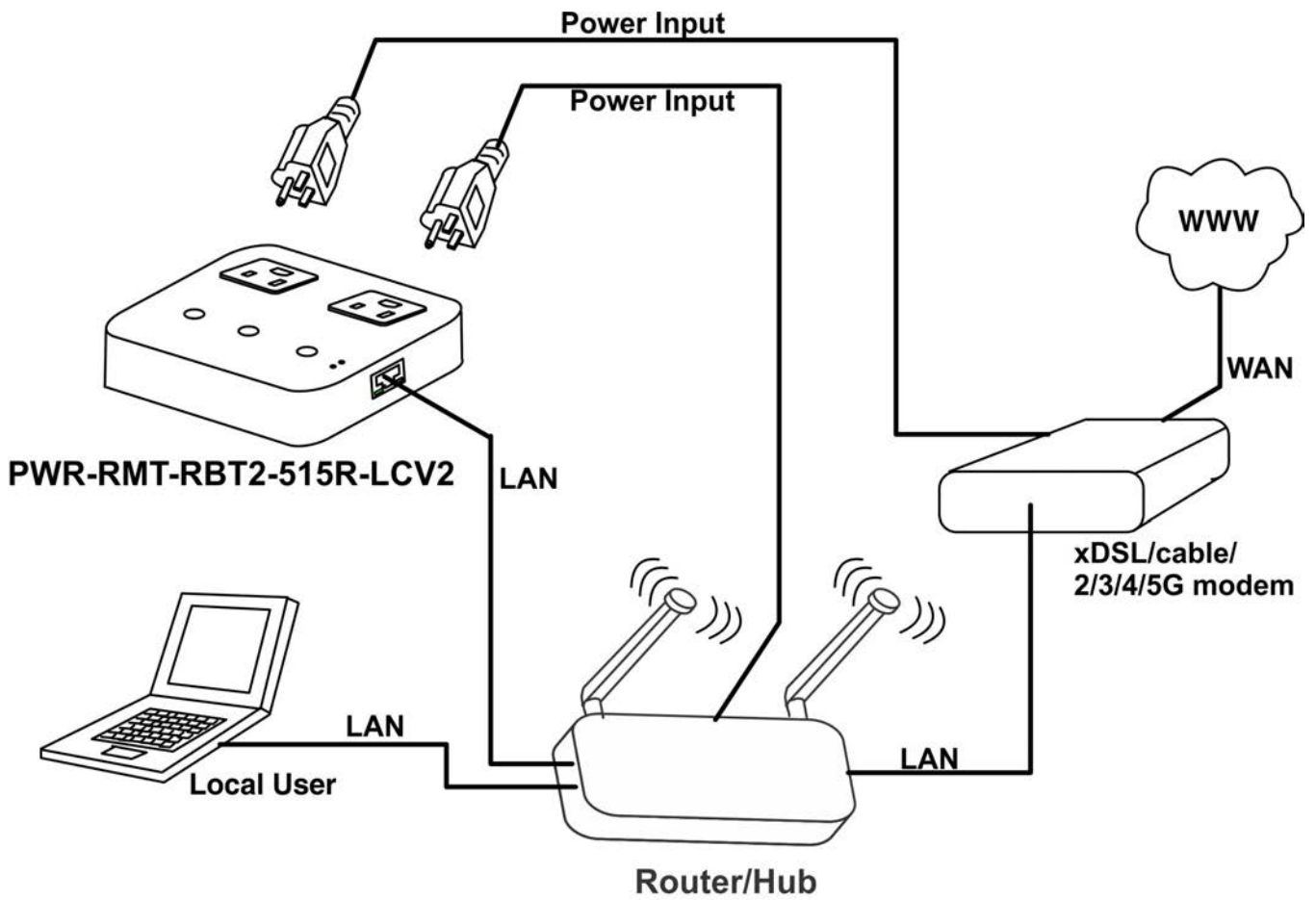

PWR-RMT-RBT2-515R-LCV2 setup to perform auto reset of router and modem

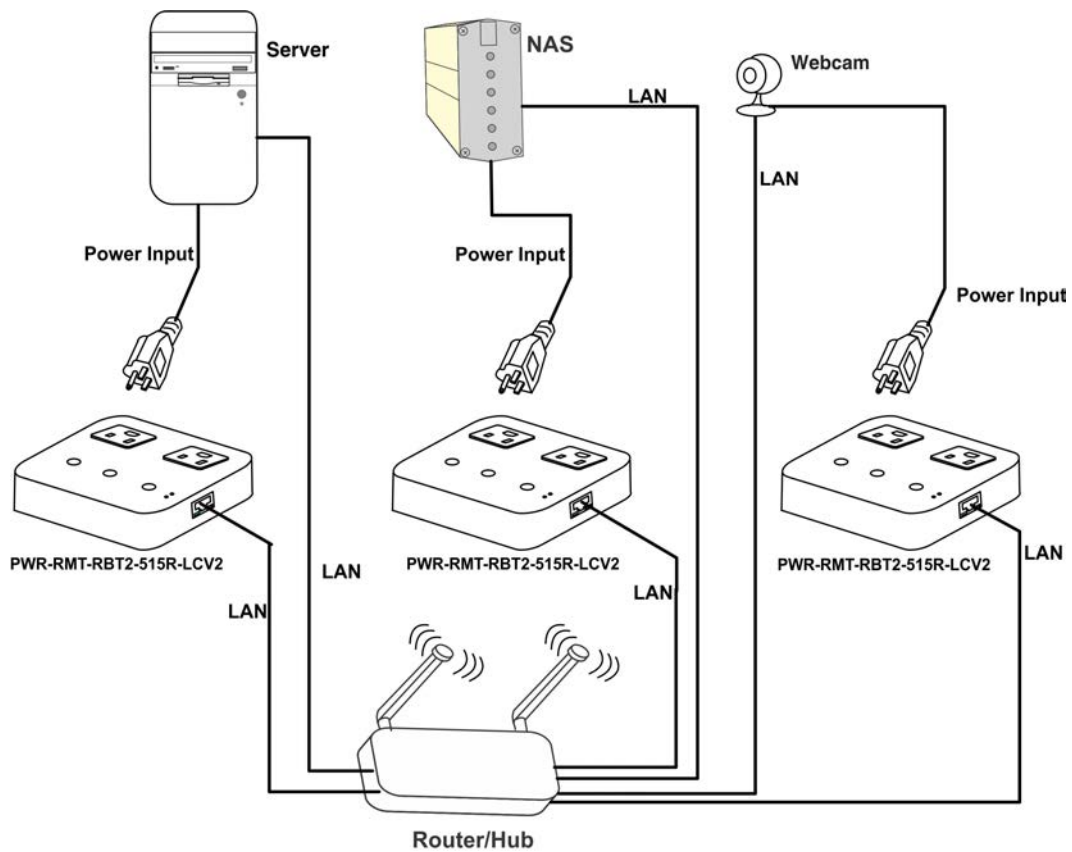

PWR-RMT-RBT2-515R-LCV2 setup to keep internet devices alive

1.4. LED Indicators Explained

LED Status for Internet & Outlets		
LED	LED status	Condition description
Internet	Solid Green	Internet connection available and UIS (Uninterruptable Internet System) mode has been activated.
Internet	Blinking Green	There is internet connection, however, at least one of the target sites is not responsive (regardless of being assigned or not)
Internet	OFF	There is no internet connection.
Cloud Link	ON	Switch is linked & connected to cloud account
Cloud Link	OFF	Switch is NOT linked to cloud account
Outlet 1 / 2	ON	Outlet is powered ON
Outlet 1 / 2	OFF	Outlet is powered OFF
Outlet 1 & 2, UIS	Blinking	Reset to Factory Default & Clear Cloud Account Link
All LEDs	Blinking	Firmware Upgrading. Do NOT interrupt or power off!
Outlet 1 & 2, UIS	Blinking in sequence	Device is in Add Mode

LED Status on LAN Port	
Light color	Condition description
Green	When On: Internet speed is at 100M When flashing: Data transmitting / receiving
Yellow	On: Internet correspond speed is 10M Flash: Data transmitting / receiving

LED Indicators

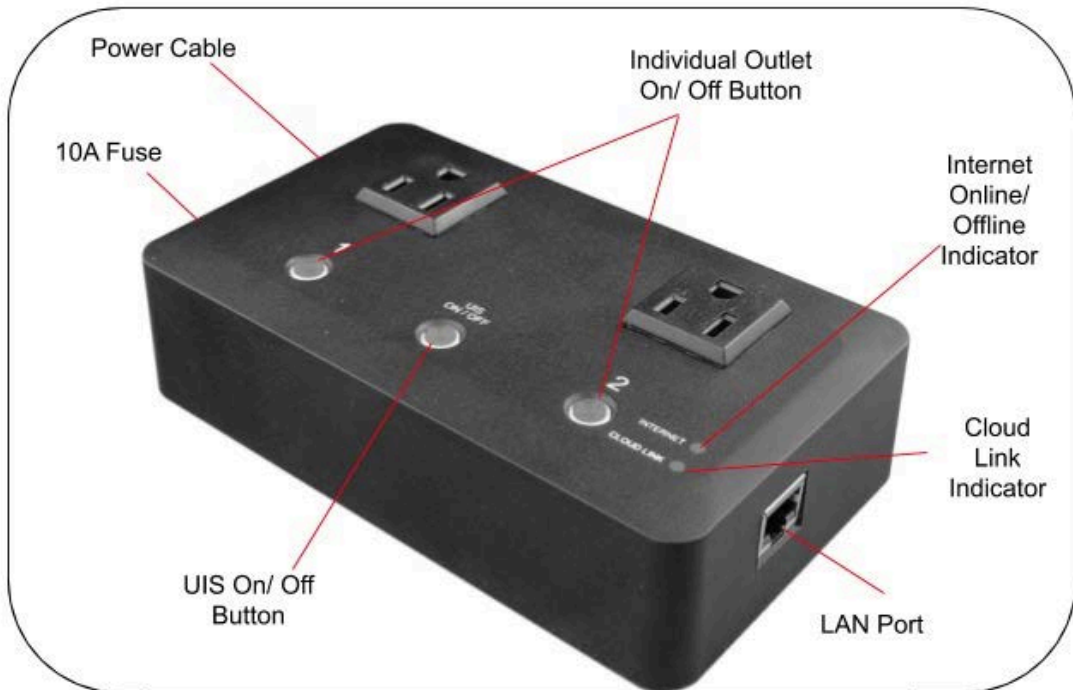

Hardware

Chapter 2: Hardware Setup

IP Switch hardware installation procedure :

Step 1:

Connect the power cord to a wall outlet.
Wait 30-50 seconds for a complete bootup.

After bootup completes, press and hold button "1" or "2" for 2 seconds to turn ON/OFF the outlet.



Step 2:

Connect the power plug(s) from the device(s) you want to control to IP Switch outlet(s).

NOTE: In order for IP Switch to maintain continuous Internet connection and reset your modem/router upon loss of Internet, the router power input must be connected here.



Step 3:

Connect LAN cable from your router to the LAN port on the IP Switch.



Step 4:

Make sure the Internet LED light is ON to show that the internet connection is available.

Press and hold the "UIS On/Off" button for 2 seconds to activate Auto Reset, which will allow the switch to reset upon loss of connection to the Target sites (i.e web site addresses or local IP addresses).



Chapter 3: Software & Web Setup

3.1. Introduction

IP Switch is designed to work without having to install any software (see hardware setup above). However, it is recommended you test to ensure the settings are appropriate for your network. The unit can also be customized and configured for remote access. This gives the user further control over the outlets when not on site.

There are multiple ways to remotely control the outlets (from WAN);

- Built-in Web User Interface using Dynamic DNS (or static IP) and Port forwarding, see Section 3.3
- mobile app (Android & iOS app (ezDevice))
- Instant messaging tool (Google Hangouts or Skype), see Section 3.4.
- API (download from webUI under Configuration -> Heartbeat -> Help)

3.2. How to Locate & Access IP Switch in LAN

IP Switch comes with a built-in Web User Interface (Web UI) that allows for more control over the unit. There are two ways of accessing the Web UI in LAN (**i.e. when both IP Switch and PC is connected to the same router**).

- Utility program (available for Windows only)
- Use a fixed IP (when there's no DHCP server).

***Note**—You can also use any LAN program to locate the Web UI URL; for example:

Mac: *LANscan*

Windows: *Wireshark* or *Angry IP Scanner*

3.2.1 Locate IP Switch in LAN using Utility program.

Step 1:

Download the Utility program from <http://www.networktechinc.com/control-power-reboot.html#tab-4> and install.

Once installed Utility will locate and list IP Switch unit(s).

NOTE: Utility can only discover the IP Switch units that are located within the same LAN or network. Be aware that certain things such as VPN, antivirus, admin privileges, etc, can prevent Utility from locating your device(s).

Utility will show LAN IP if units are connected to a Router. If you are connecting to your computer directly, you will need to manually assign an IP address to the device via the 'Network' tab, as well as manually set an IP for your computer's Ethernet adapter.



Step 2:

Click “**Launch Web User Interface**” to open your web browser and access the Web UI of the unit.

A password dialog box will appear and prompt you to log in.

By default; Username is **admin**/ password is **listed on bottom label**. Press “**OK**” to proceed.

At first login, or after a factory reset, the user will be asked to create an admin account.

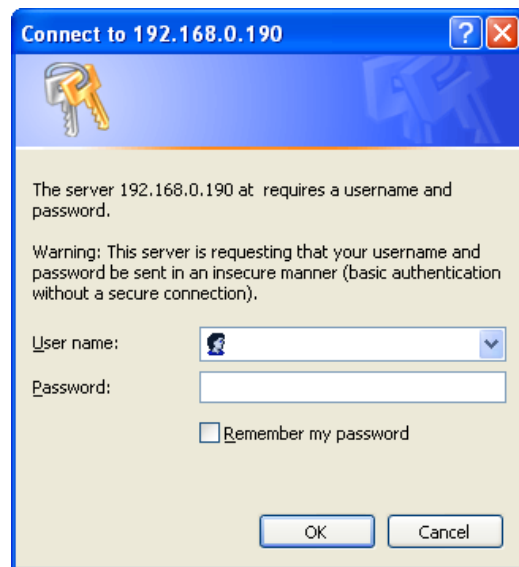

Step 3:

You will be logged into the IP Switch.



3.2.2 Locate IP Switch in LAN using fixed IP

By default, the IP Switch should obtain an IP address automatically from your router using DHCP. If for some reason it does not, it will revert to **0.0.0.0**. Using **Utility -> Network Settings** will allow you to apply a manual/ static IP setting. You may also **press and hold the UIS button for 10 seconds** and it will revert to a **fixed LAN IP of 192.168.0.100**.

To access IP Switch Web UI via fixed LAN:

Step 1:

Connect the LAN cable from IP Switch to your PC's Ethernet port

Step 2:

Assign a fixed IP within the same subnet to your PC. **Example:** IP address: 192.168.0.20; Subnet Mask: 255.255.255.0; Gateway: 192.168.0.1

Step 3:

On your PC, launch a web browser and enter the IP: 192.168.0.100 - **Login username/ password: admin/ Password listed on bottom label** . You can now change this fixed IP address to one that you prefer by going to **Configuration Settings -> Network**.

3.3. How to Access IP Switch from WAN – using DDNS

The IP Switch Web User Interface (Web UI) can be accessed remotely from Wide Area Network (WAN). To do so, you must have a public dynamic IP address from your ISP (Internet Service Provider) - if you're unsure about this, please contact your ISP. Remote access via a public static WAN IP will work the same, though a Dynamic DNS account is NOT needed. Once you've confirmed what type of IP you have, proceed as follows;

- i. Setup port forwarding at your router.
 - a. Log into your router setup / configuration page.
 - b. Most routers will have these settings under the **Firewall / Port Forwarding / Virtual server** section. You will need to **open (allow)**: TCP Port 80. (**NOTE**: You may need to forward port 80 to a different port if you have other devices on the network using that port. You may also see **section 4.2.3 -> HTTP Port** if you want to instead change the port of the Switch)
- ii. Setup a Domain Name for your Dynamic WAN IP. Use 3rd Party DDNS providers. To do so;
 - a. The following 3rd party DDNS providers below are supported;
 - 3322.org
 - DynDNS (Dynamic)
 - DynDNS (Custom)
 - myDDNS.com
 - No-IP
 - b. Create a new user account and password with a DDNS provider.
 - c. Register a Domain Name for your current Dynamic WAN IP.
 - d. Log into your outlet via its local IP Address and navigate to → **Configuration Settings** → **Network** → **Dynamic DNS**. Select the DDNS provider; enter the registered domain name, user account, and password. Click **Apply**.

The IP Switch is now accessible remotely using the newly registered Domain Name. For further description of **Network** → **Dynamic DNS** configuration, see **section 4.2.3**.

3.4. How to Access IP Switch from WAN - using Hangouts

IP Switch supports Google Hangouts, an instant messaging tool. Once setup, user can get notifications and issue commands to check the status, as well as turn on/off power or reset the outlets. Before starting, confirm your **firmware** is up to date. You will also need to set up **2 Gmail accounts** - 1 designated as the IP Switch & 1 as the Control account.

For troubleshooting, including how to use Gmail with 2-step authentication, see **Section 5 – Troubleshooting tips.*

3.4.1. How to Setup Hangouts

Step 1:

From the Utility application, select **'Launch Web User Interface'** - when prompted, log in with the default user name & password.



User Name: admin

Password: -see bottom label-

NOTE: If Utility cannot locate your Switch, please refer back to section 3.2.1

Step 2:

Below the **'Configuration Settings'** button on the left, select **'Hangouts'**

a. Refer to **'Status'** (*offline by default*) - You will need to change this to **'Online'**

b. For the **'Login ID,'** enter the Gmail Account for the Switch (Example: IPswitch@gmail.com).

c. Enter the Password (or APP Password if using 2-step verification – see **section 5.2.1**) for the same Gmail account in the **'Password Field'** to the right

d. Under the **'Add Contact Accounts'** enter your control Gmail account that will be used to control the switch (Example: control@gmail.com)

e. Click **'Apply'** to save



Login ID	Password
IPSwitch@gmail.com	*****
Show a Personal Message for Account	
IP switch	
Add Contact Accounts (to access / control the above account) [help]	
control@gmail.com	

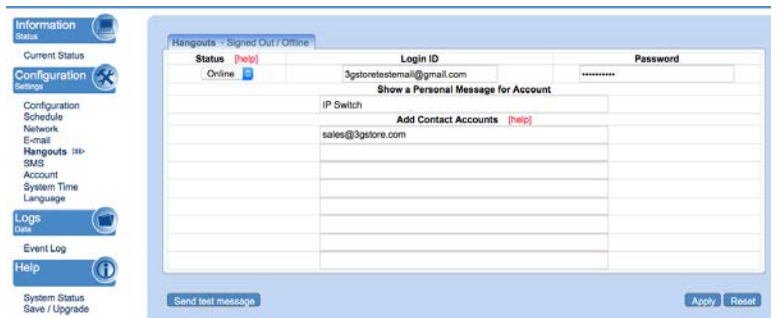

Step 3:

Allow a few moments for the Switch to connect and Sign in.



Step 4:

Once connected, log into your control Gmail account. Do NOT log into the Switch account. The users listed in your **Contact List** will receive a notification to add the IP Switch as a 'contact'.

Once added, you can control the IP Switch by chatting with it.

***NOTE:** If you do not receive an 'invite', you may need to log into the Switch's Gmail account to ADD CONTACTS manually.



3.4.2. How to Control IP Switch using Hangouts

After setting up and getting connected as above. Bring up the IP Switch chat window by inviting it to chat.

***NOTE:** Typing in anything other than the Keywords will invoke IP Switch to respond with "**Please type HELP to list available commands.**"

Available commands are (non case sensitive):

-SET [ON/OFF/RESET] [0/1/2] (where 0=both outlets, 1/2=Outlets)

-UIS [ON/OFF]

-GET [IP/STATUS]

SET ON / OFF / RESET command will return a "Done!" once IP Switch has completed the action.

GET IP command will return the WAN IP and the unit's LAN IP address.

***NOTE:** If port forwarding is set, but not the domain name, user can still use WAN IP to access the IP Switch Web User Interface from internet.

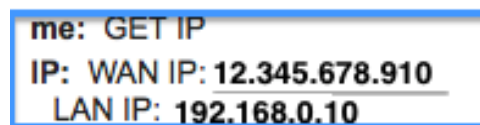
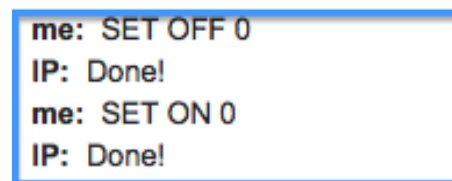
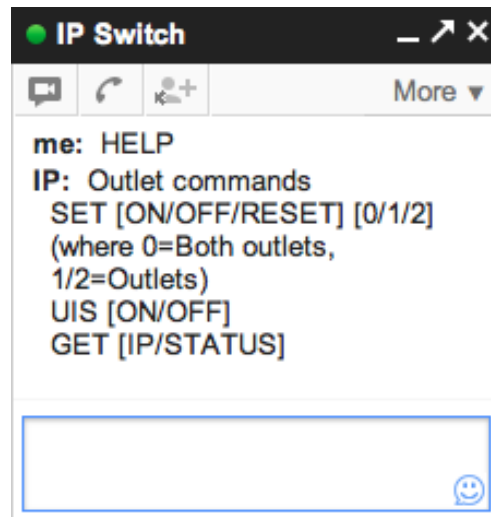

GET STATUS command will return the following information.

For **[Outlet Status]** the Outlet1 and Outlet2 name can be assigned. This is done via the local IP address of the IP Switch → **Configuration** → **Outlet Setup**

**Use Mobile Device to Control: There is also a mobile application called "Hangouts" that can be used in this same manner. It is available for Android and iOS.*

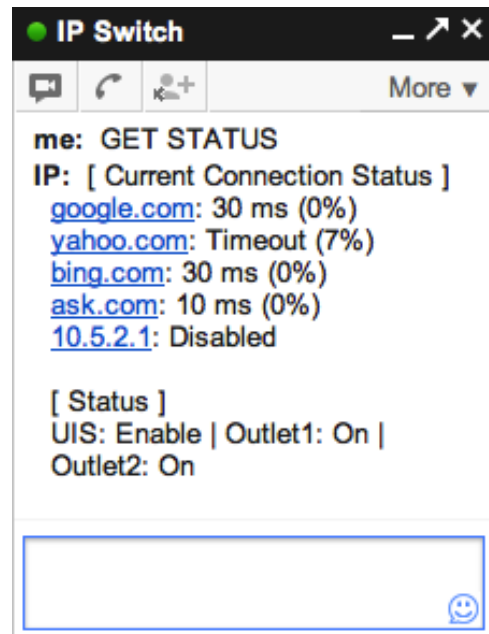

3.5. How to Access IP Switch from WAN – Using Skype

As an alternative to the Google Talk/ Hangouts, you can now use Skype to monitor and control your outlets.

Step 1: Connect your computer to the same network as the IP Switch. Open a web browser to its IP Address (e.g. **192.168.0.197**). If the IP Address is unknown, refer to **section 3.2**

Step 2: Admin Screen

1. Login when prompted (default username & password: **admin ** -- see bottom label for password)
2. Select **Skype** on the left
3. Click **Enable** for the **Skype Function**
4. Click **Auto Rebooter** (a separate window will open; see Step 3)
5. Click **Apply**

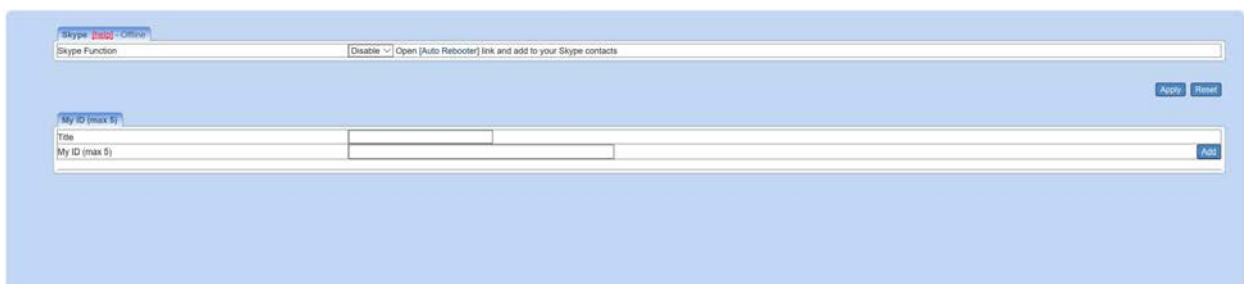

Step 3: Auto Rebooter

1. Click **Add to Contacts**

Step 4: Open The Skype App

1. Under the **Contacts Section** select **Auto Rebooter**



ibs: IP Cameras and network devices are prone to freeze

2. Type **Help**
3. Click **Get My ID**

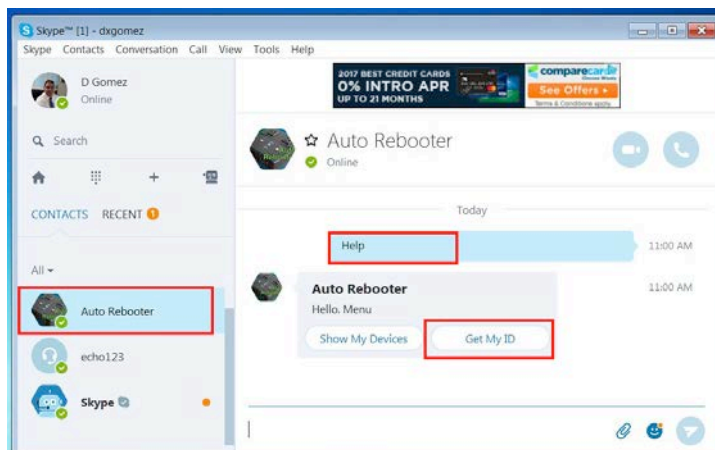

4. Copy and Paste the ID

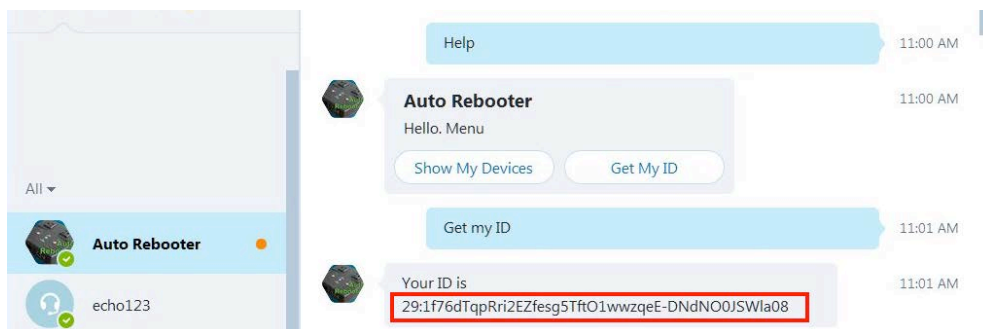

5. Toggle back to the **Admin Screen**
6. Enter the Name for your Switch (*any name you want to represent*)
7. Paste the ID in the **ID field**
8. Click **Add**



Step 5: Skype Control

1. Switch back to the **Skype App**
2. Click on **Help** then **Show My Devices**
3. Select the button that corresponds to the action you wish to perform
4. Example **Status**
5. **Status** will be displayed

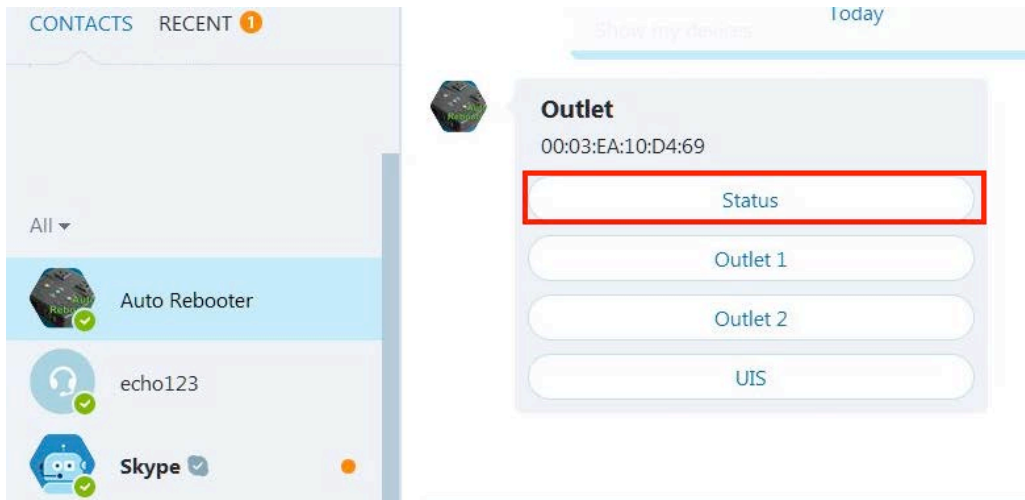

Command example

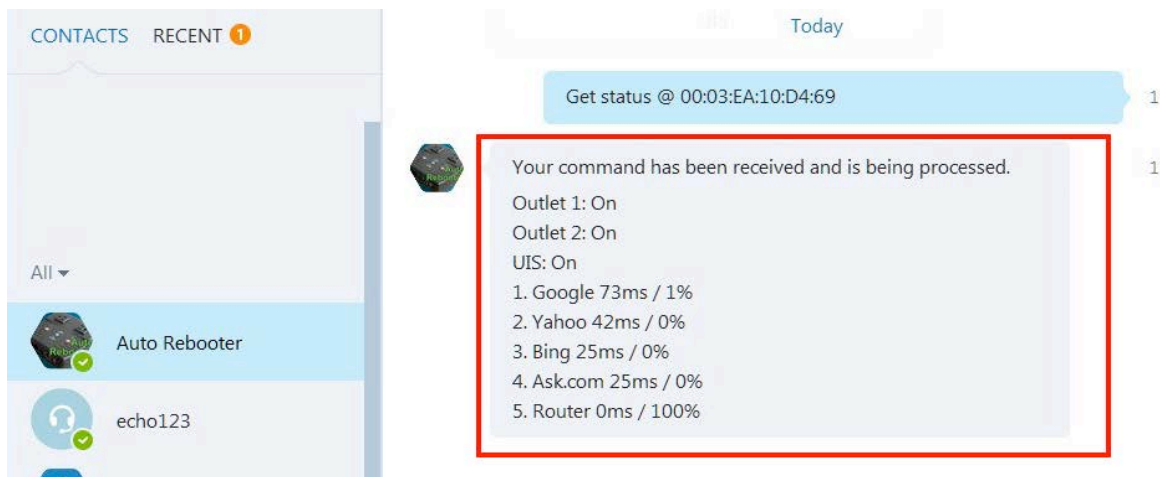

Result

Other Commands:

Outlet 1 or 2: Turn ON/ OFF, Reset

UIS: Turn ON/ OFF

***NOTE:** If you have multiple outlets, you may use the same ID (from Get My ID).

3.6. How to Access IP Switch from Mobile App

The Switch can be controlled at any time, from any where in the world (as long as it has an Internet connection), using a mobile app called ezDevice (available on the App Store and Google Play Store).

Follow these steps for adding the Switch via the mobile app

1. Make sure your computer is connected to the same LAN as the Switch.
2. Refer to **Section 3.2** for instructions on accessing your Switch's web user interface page and log in.
3. Go to **Configuration -> Network** page and **Enable** the **Cloud Service**. Click Apply to save (see also **Section 4.2.3**)
4. Open the Google Play or App Store and search for: **ezDevice**
5. Install the app and open it. Select **Sign Up** to create yourself account OR **Log In** if you already have one.
6. Click **Add Device** at the top right
7. A new window will open that says **Add Device**. It should automatically find the device by the IP address your router has assigned it. If not, you can manually enter its serial number
8. Click the **+** button to the right of the device
9. Next, you'll be prompted to enter the **Device Key** to complete the addition. Refer to the **Password** listed on the bottom label of your Switch
10. Click **Next** to complete and then **Done**
11. You should now see your device listed on the home page

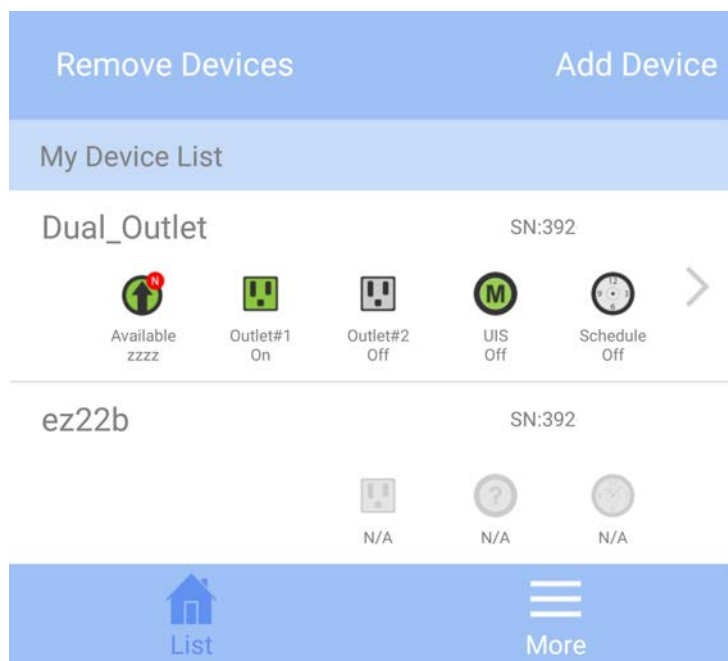

3.7. How to Upgrade/ Re-Flash Firmware

When issues occur with your IP switch, it is best to upgrade firmware (if available) or re-flash the current version of firmware. This can be done with the Utility application OR via the local web interface page. It can be accomplished with a computer that is connected to the same network as the IP switch or, in certain cases when the IP Switch is unreachable, you may connect it directly to your computer via the Ethernet cable.

***NOTE:** Before performing the upgrade, it is recommended that you save your settings. See **section 4.4.1** for instructions on the Save/ Restore settings info.

Upgrade Using Utility

Step 1: Launch the 'Utility' Windows Application and let it detect IP switch.

Step 2: Click on the 'Firmware Upgrade' button.

NOTE: If Utility cannot locate your Switch please refer back to section 3.2.1

Step 3: In the dialog box that opens, select the '...' button to the right of 'File Name.'

Step 4: Locate the firmware file and open it.

Step 5: The file name should now appear in the appropriate field. Now, select the 'Download' button

NOTE: The firmware process takes about 2-5 minutes.

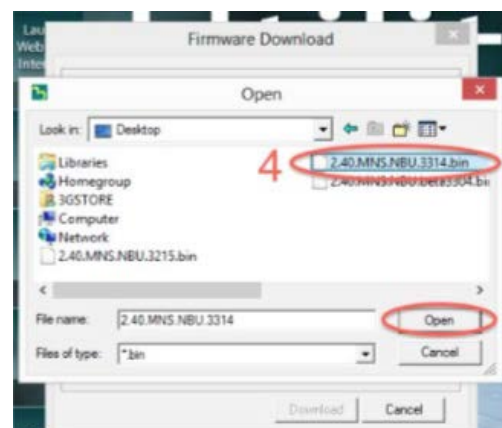
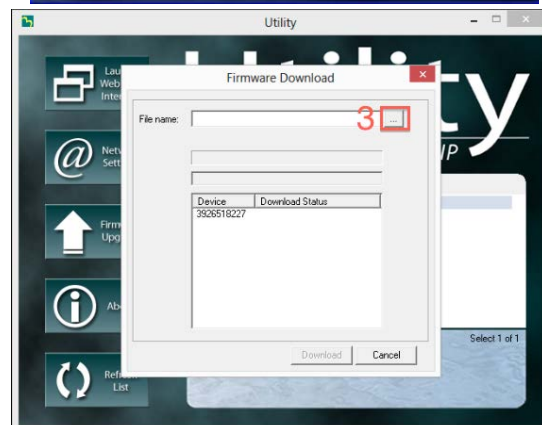

Upgrade Using Local Web UI

Step 1: Log into the web user interface of your IP Switch

Step 2: Navigate to the **Save/Upgrade** section (on the left)

Step 3: Under the **'Upgrade Firmware'** section, click on the **'Browse'/ 'Choose File'** button beside **'Location'**

Step 4: A window will open to view your computer files. The firmware typically saves to your downloads folder. Select the **.bin** file named and click **Open**

Step 5: You'll now see the file appear next to **'Location'** -> Click **Apply** to begin the upgrade

NOTE: The firmware process takes about 2-5 minutes.

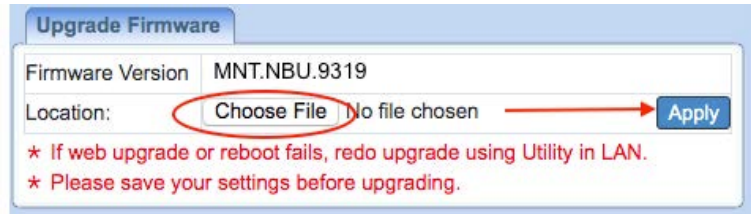
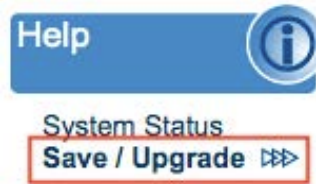

Chapter 4: IP Switch Web User Interface

4.1. Information

The Information tab displays an overview of the device's current status (i.e. target site response times, UIS and Outlet On/ Off indicators as well as control).

4.1.1 Current Status

This section displays the current status of the outlets.

- Information
- Current Status
- Configuration
- Configuration
- Schedule
- Network
- E-mail
- Hangouts
- Skype
- Account
- System Time
- Language
- Logs
- Event Log
- Help
- System Status
- Save / Upgrade
- Logout

Connection Status

Assign	Site Label	Target Site	IP Address	Response Time	Timeout
Both	Google	www.google.com	172.217.9.196	37 ms	0 %
	Yahoo	www.yahoo.com	98.138.219.232	57 ms	0 %
	Pingler	www.pingler.com	216.158.76.82	97 ms	0 %
None	Ask.com	www.ask.com	151.101.194.114	29 ms	0 %
	Router	192.168.3.3	192.168.3.3	1 ms	0 %

Status and Control

Item	On/Off Control
UIS Reset	

■ Assigned outlet will auto reset when target site timeout. Only outlets that are On will reset.
■ Assigned outlet will not reset when connection loss is detected.

Status and Control

Outlet Name	Status	Control
Outlet 1	On	Reset
Outlet 2	On	Reset

[Reset All](#)

■ Outlet On ■ Outlet Off ■ Outlet is On, UIS Reset function is Off

i. **Connection Status**

Assign: This shows the outlets that are assigned to the target sites

Site Label: A name for the target site

Target Site: This is the default target site as listed under Configuration page

IP Address: The IP address of the Target Site

Response Time: based on UDP / TCP protocol sets in Configuration page

Timeout: Number of timeouts as a percentage of total tries since reset.

***NOTE: This page will auto refresh every 5 seconds**

ii. **Status and Control**

This section shows the current status of the UIS Function and Outlet. User can click to control the Outlets or UIS function from here.

Icon	Description
	The <i>UIS Function</i> is Off. IP Switch will not perform auto outlet reset when connection loss is detected.
	The <i>UIS Function</i> is On. IP Switch will perform auto outlet reset when connection loss is detected.
	The Outlet is Off
	The Outlet is On
	The Outlet is On, but <i>UIS Function</i> is Off. The outlet will not auto reset.

4.2 Configuration

The following option allows the user to configure the IP Switch.

- 4.2.1 Configuration
- 4.2.2 Schedule
- 4.2.3 Network
- 4.2.4 E-mail
- 4.2.5 Account
- 4.2.6 Google Talk/ Hangouts
- 4.2.7 System Time
- 4.2.8 Language
- 4.2.9 SMS

4.2.1 Configuration

Use this section to configure how IP Switch checks websites. Advance users can use this to customize IP Switch to check network devices.

- Information Status
- Current Status
- Configuration Settings
- Schedule
- Network
- E-mail
- Hangouts
- Skype
- Account
- System Time
- Language
- Logs Data
- Event Log
- Help
- System Status
- Save / Upgrade
- Logout

Website / IP Address	Assign	Site Label	Website / IP Address	Response Time	Protocol
	Both	Google	www.google.com	37 ms	<input checked="" type="radio"/> Ping <input type="radio"/> HTTP
	Both	Yahoo	www.yahoo.com	57 ms	<input checked="" type="radio"/> Ping <input type="radio"/> HTTP
	Both	Pingler	www.pingler.com	97 ms	<input checked="" type="radio"/> Ping <input type="radio"/> HTTP
	Both	Ask.com	www.ask.com	29 ms	<input checked="" type="radio"/> Ping <input type="radio"/> HTTP
	None	Router	192.168.3.3	1 ms	<input checked="" type="radio"/> Ping <input type="radio"/> HTTP
	None				<input checked="" type="radio"/> Ping <input type="radio"/> HTTP
	None				<input checked="" type="radio"/> Ping <input type="radio"/> HTTP

Heartbeat	
Assign	None
Timeout within	10 second(s)

Outlet Setup	
Outlet 1 Name	Outlet 1
Outlet 2 Name	Outlet 2
Power-on delay for Outlet1	3 second(s)
Power-on delay for Outlet2	13 second(s)

Timeout Settings	
Timeout for Each Website / IP Address	5 second(s)
Set Ping Frequency	10 second(s)
Number of Continuous Timeout Cycles	3 times
Ping Delay After UIS Reset	4 minute(s)
Number of UIS Resets	Limited 1 times
Force UIS Reset after initial power-on	Enable
Detect unplugged LAN cable	Disable

i. Website / IP Address

Assign	Site Label	Website / IP Address	Response Time	Protocol
Both	Google	www.google.com	37 ms	<input checked="" type="radio"/> Ping <input type="radio"/> HTTP
Both	Yahoo	www.yahoo.com	57 ms	<input checked="" type="radio"/> Ping <input type="radio"/> HTTP
Both	Pingler	www.pingler.com	97 ms	<input checked="" type="radio"/> Ping <input type="radio"/> HTTP
Both	Ask.com	www.ask.com	29 ms	<input checked="" type="radio"/> Ping <input type="radio"/> HTTP
None	Router	192.168.3.3	1 ms	<input checked="" type="radio"/> Ping <input type="radio"/> HTTP
None				<input checked="" type="radio"/> Ping <input type="radio"/> HTTP
None				<input checked="" type="radio"/> Ping <input type="radio"/> HTTP

Assign:

Assign either one or both outlets to the website / IP address. Outlet assigned to a group of websites will auto reset, when all sites within that group timeout.

NOTE: Assignment cannot be for a combination of both and single outlets.

Site Label:

An easy to remember name for the site. Max 16 characters.

Website / IP Address:

Enter a reliable website / IP address to ping.

Response Time:

The time it takes for a website to respond.

Protocol:

Select a suitable ping method for the website. Options include: Ping (UDP) or Web Request (TCP).

***NOTE:** The target site can be a Domain Name, IP Address or even LAN IP Address – e.g. the router's IP or local device on the router such as an IP Camera. Your Router IP will be filled in automatically and is meant for cases where user want to ensure that an Auto Reset event is only due to Router crashing, and not just a failure of external IPs.

Heartbeat: This feature is an alternative to using the Website/ IP addresses for UDP/TCP Ping requests. An HTTP command will be sent instead

Heartbeat [help]		
Assign	None	When assigned ping function will be disabled.
Timeout within	10 second(s)	1 - 3600 seconds.

Assign

Select **None** to disable this setting (default); OR

Select a single outlet or **BOTH** outlets to control what is reset upon no response.

Timeout Within

Set the time that the HTTP command must respond within. If it does not respond within this time, the outlet(s) will be reset.

ii. Outlet Setup

Outlet Setup [help]		
Outlet 1 Name	ISP	Normal
Outlet 2 Name	Switch	Reset Only
Power-on delay for Outlet1	20 second(s)	
	1 - 600 seconds.	
Power-on delay for Outlet2	60 second(s)	
	1 - 600 seconds.	

Outlet 1/ 2 Name:

Apply a name to easily identify the connected device (e.g. router, modem, etc).

Normal vs Reset:

If user wants to have manual ON/ OFF control while the UIS Auto Reset is enabled, select **Normal**. If user wants to ensure the outlet(s) are not turned off remotely by mistake, set **Reset Only**.

Power-on Delay for Outlet 1:

Apply a delay (Power Off > Delay > Power On) to Outlet 1 power-cycle sequence. *Default is 3 seconds– configurable from 1-600 seconds.*

Power-on Delay for Outlet 2:

Apply delay to Outlet 2, which takes place after Outlet 1 is reset. In default configuration, Outlet 2 resets 13 seconds after Outlet 1. *Default 10 seconds – configurable from 1-600 seconds.*

***NOTE:** Power Delays also apply to scheduled or manual resets. Only outlets that are currently powered on will power cycle upon an auto reset.

iii. **Timeout Settings**

Timeout Settings [help]	
Timeout for Each Website / IP Address	5 second(s) <small>1 - 60 seconds.</small>
Set Ping Frequency	10 second(s) <small>10 - 3600 seconds.</small>
Number of Continuous Timeout Cycles	3 times <small>1 - 10 timeouts.</small>
Ping Delay After UIS Reset	4 minute(s) <small>1 - 30 minutes.</small>
Number of UIS Resets	Limited 1 times <small>1 - 30 times.</small>
Force UIS Reset after initial power-on	Enable
Detect unplugged LAN cable	Disable

Timeout for Each Website / IP Address

Assigned websites must respond within this time or it is considered a timeout. Set a larger value to allow for occasional Internet lags. *Default is 5 seconds.*

***NOTE:** A larger timeout will allow for instances of delay or lag from target sites.

Set Ping Frequency:

Administrator can set the website ping or connect interval (i.e. how frequently the Switch pings the target sites). *Default is 10 seconds.*

Number of Continuous Timeout

Number of continuous failed responses from assigned websites before the UIS reset is triggered. *Default is 3 times.*

Ping Delay After UIS Reset:

Set how long the Switch waits after a UIS reset BEFORE it starts checking for a connection again. *Default is 4 minutes.*

Number of UIS Resets:

Set the number of UIS reset attempts when Internet connection is lost (e.g. When set to 5 times: if connection is not restored after the 5th attempt, Switch will wait in idle state until connection comes back). *Default is 1 time.*

Force UIS Reset after Initial power-on:

Force the outlets to reset if all sites are unreachable after power-on (e.g. Router boot failure after a power outage). Only outlets that were ON (before power off) will reset. UIS function **MUST** be enabled for this to work. *Default is Enable.*

4.2.2 Schedule

This option allows the user to schedule the power on / off / reset for each of the two outlets. A total of 20 schedules can be assigned.

Create New Schedule	
Item	<input type="radio"/> All Outlets <input checked="" type="radio"/> Outlet 1 <input type="radio"/> Outlet 2 <input type="radio"/> UIS Reset
Action	<input checked="" type="radio"/> On <input type="radio"/> Off <input type="radio"/> Reset
Date (yyyy/mm/dd)	<input checked="" type="radio"/> Once: 2016/06/17 <input type="radio"/> Every: <input type="checkbox"/> Sunday <input type="checkbox"/> Monday <input type="checkbox"/> Tuesday <input type="checkbox"/> Wednesday <input type="checkbox"/> Thursday <input type="checkbox"/> Friday <input type="checkbox"/> Saturday
Time (hh:mm)	<input type="text" value="06:20"/> (24 hour format)

i. New Schedule Event

Item: Select to schedule an event for either Outlet 1 or Outlet 2, both, or UIS Reset.

Action: Select action to apply to above Outlets: **ON**, **OFF** or **RESET**.

Date (yyyy/mm/dd)

Select the event frequency for the above outlet:

- a. Once (the current date is automatically entered) or;
- b. Reoccurring on a particular day, or a daily event.

Time (hh:mm): Enter the time in 24hr format.

4.2.3 Network

This option allows the user to configure the IP address, port number and DDNS functions.



i. IP Address

IP Address [help]	
Hostname	http://Outlet_1 Outlet_1
IP Address	192.168.3.115
Subnet Mask	255.255.255.0
Default Gateway	192.168.3.3
Obtain an IP address	DHCP <input type="button" value="v"/>

Hostname

By default the hostname (*LAN Domain Name*) is set to **Outlet**. This should allow the unit to be located on your router's client list when determining the LAN IP address.

***NOTE:** If running multiple IP Switch units, assign different hostnames to each.

IP Address

This determines/ displays the IP Switch's IP address. By default, the LAN IP address assignment method is set to DHCP (IP address assigned by router).

***TIP:** We suggest changing this to a Fixed/ Static IP for ease of management. You may do this by selecting 'Manually' rather than 'Using DHCP' –OR, you can

leave as DHCP and simply set a DHCP reservation on your router so that the IP address does not change.

Subnet Mask

Displays IP Switch Subnet Mask.

Default Gateway

This sets the IP Switch Gateway IP address (this is the IP address of the router the IP Switch is connected to).

Obtain an IP address

This allows the user to either manually set or use DHCP (default) function to obtain the IP address from the router. Click Apply to save settings.

***NOTE:** Remote Power IP Switch will reboot when these settings are changed.

ii. DNS Server IP

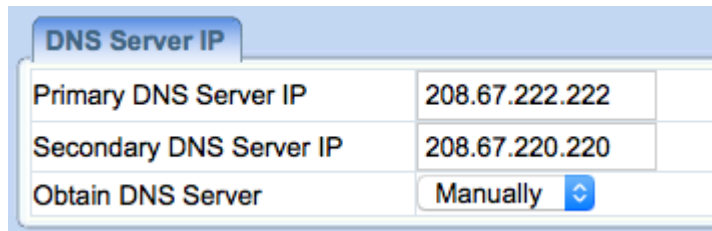

The screenshot shows a configuration window titled "DNS Server IP". It contains three rows of settings:

Primary DNS Server IP	208.67.222.222
Secondary DNS Server IP	208.67.220.220
Obtain DNS Server	Manually <input type="button" value="v"/>

Primary DNS Server IP

User can set their preferred DNS server / one that is assigned by ISP. *Default is 208.67.222.222.*

Secondary DNS Server IP

Use this to set a **Secondary DNS Server IP address**. IP Switch will use this if the **Primary DNS Server IP** address is not working. *Default is 208.67.220.220.*

Obtain DNS Server

This allows the user to either manually set (default) or use AUTO function to obtain the DNS servers from the router.

iii. Advanced Options

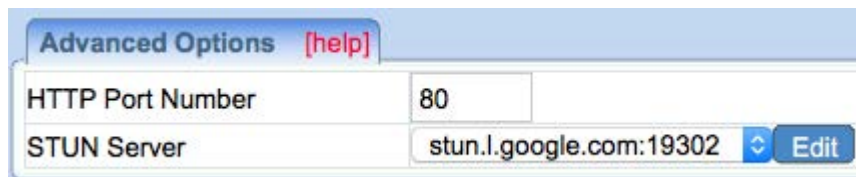

The screenshot shows a configuration window titled "Advanced Options" with a "[help]" link. It contains two rows of settings:

HTTP Port Number	80
STUN Server	stun.l.google.com:19302 <input type="button" value="v"/> <input type="button" value="Edit"/>

HTTP Port Number

This determines IP Switch user interface port. By default the LAN port number is **80**. If the port is changed, you will also need to change the manner in which

you access the switch via a web browser – i.e. If the port is changed to 82, then to access IP Switch user interface, the user must type: <http://x.x.x.x:82> (where x.x.x.x is the IP Switch's LAN IP address as shown in Utility).

***NOTE:** Remote Power Switch will reboot when these settings are changed.

STUN Server

STUN is a standardized network protocol to allow the device to discover its public IP address when it is located behind a NAT. Disabling STUN will do the following:

- a. Prevent Google Hangouts “**GET IP**” command from returning the **WAN IP**
- b. Email notification cannot show the current **WAN IP**
- c. Dynamic DNS server cannot acquire **WAN IP**

Default is `stun.l.google.com:19302`

iv. Dynamic DNS



Dynamic DNS [help]	
DDNS Provider	DynDNS(Dynamic)
Domain Name	ipswitch3G.dyndns.org
Name	3gstore
Password	*****

Dynamic DNS (“DDNS”) is a third party service – some providers offer free service, others require a fee. It allows the user to alias a dynamic WAN IP address to a WAN hostname. So no matter how many times your ISP changes the IP address, you will be able to locate your unit over WAN using your DDNS hostname.

DDNS providers include:

- 3322.org
- DynDNS (Dynamic)
- DynDNS (Custom)
- myDDNS.com
- No-IP

In general, to register a Domain Name with one of these sites;

- a. Go to the DDNS provider website listed above.
- b. Register a new user account and password with the DDNS provider.
- c. Choose a Domain Name to point to your current Dynamic IP
- d. Enter information obtained in (b) and (c) into the corresponding DDNS fields in IP Switch.

Domain Name

This is the Domain Name you have created from the above selected DDNS provider.

Name

This is the Login / Account name that you have created with the selected DDNS provider.

Password

Enter the Password you have assigned to your DDNS Account.

4.2.4 E-mail **NOTE: To use gmail for the IP Switch, user will need to allow less secure app access**

This function will send event notifications to email accounts listed in the 'E-mail Address Book'. Events are also logged in "Event Log" section.

The screenshot shows a web interface with a left sidebar and a main content area. The sidebar includes sections for Information (Status), Configuration (Settings), Logs (Data), and Help. The main content area has a tab for 'E-mail Settings' with a '[help]' link. Below the tab is a table for configuration:

E-mail Notification	Disable ▾
E-mail Server	
E-mail Port	25
Sender's E-mail Address	
User Name	
Password	

Below the table are 'Apply' and 'Reset' buttons. Underneath is a section for 'E-mail Address Book' with an empty input field and an 'Add' button.

i. E-mail Settings

The screenshot shows the 'E-mail Settings' configuration page with the following values:

E-mail Notification	Enable ▾
E-mail Server	smtp.gmail.com
E-mail Port	587
Sender's E-mail Address	support@gmail.com
User Name	support@gmail.com
Password	*****

E-mail Notification

When 'Enabled' and settings are applied, user can receive notifications from the Switch. 2 additional sections will appear that also must be configured – 'Test E-mail' and 'E-mail Address Book'

E-mail Server

Only SMTP servers are supported (IMAP and HTTP are *not*). **Example:** *smtp.gmail.com*

E-mail Port

Default is port 25. User can specify a different port if necessary. **Port 465 and 587 is frequently used.*

Sender's E-mail Address

Enter the full E-mail address assigned by your e-mail server.

User Name / Password

Enter your full E-mail Address and the password associated with it.

***NOTE:** If you are using Google 2-step Authentication see **section 5** for additional configuration steps.

ii. E-mail Address Book

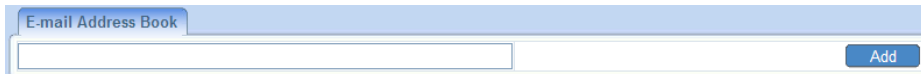

The screenshot shows a light blue header with the text "E-mail Address Book". Below the header is a white input field with a blue border. To the right of the input field is a blue button with the text "Add".

E-mail Address Book

List the users who shall receive an e-mail notification, as they appear in the Event Log section. Refer to the **Events** button beside each address to control what notifications are sent.



The screenshot shows the same "E-mail Address Book" header. Below it, the input field contains the text "@gmail.com". To the right of the input field are two buttons: "Add" and "Delete". A red circle is drawn around the "Event" button, which is located to the left of the "Delete" button.

4.2.5 Account

This webpage allows you to change the administrator login. You may also set up a 'viewer' account, which may view settings, but cannot make changes. *A maximum of 5 user accounts can be configured.*

Account Settings			
Permission	Login	Password	Confirm Password
Administrator	admin	*****	
None			
None			
None			
None			

Permission

Administrator account is set up by default. **Viewer** account can be configured if users want to allow others to view the settings *without* being able to make any changes.

Login

The administrator can set a name consisting up to 32 case sensitive characters. By default the Administrator Login is admin / the password is unique to each and will be found on the bottom label.

Password / Confirm Password

Assign a password to the account. The administrator can set up to a 32 case sensitive password. Enter it a 2nd time to confirm password.

4.2.6 Hangouts

Setup IP Switch to be controllable via Google Hangouts.

Status	Login ID	Password
Offline		
Show a Personal Message for Account		
Add Contact Accounts		

Buttons: Send test message, Apply, Reset

i. Hangouts

Hangouts - Signed In / Online

Status [help]

Online

Status

i. Account Settings

This determines the status of the IP Switch's Gmail account. Select 'Online' to enable. See the tab labeled "Hangouts" above

Status [help]	Login ID	Password
Online ▾	IPSwitch@gmail.com	*****
Show a Personal Message for Account		
	IP Switch	
Add Contact Accounts [help]		
	control@gmail.com	

Login ID

Enter the Login ID that you have created from the Gmail website for the IP Switch.

Password

Enter the corresponding password with the above account.

Show a Personal Message for Account

Enter a message here. This message will be visible to anyone that is in the IP Switch's Hangouts contact list.

Add Contact Accounts (to access / control the above account)

The administrator can assign up to 8 Gmail users who can receive notification, control AND receive IP Switch feedback from their Gmail account. Once assigned, the respective user must then 'add/invite' the IP Switch to their Contact list - this chat invitation is generated once the Administrator clicks 'Send Test Message'.

NOTE: Failing to accept the chat invitation will result in the user not being able to communicate with the IP Switch. Once the contact is added, just type a random character and IP Switch will respond with instructions. Refer to **section 3.4.2** above on how to use Hangouts.

4.2.7 System Time

Use to set the time zone, apply daylight savings start/end, and configure the system for automatic restarts.

System Time	
System Time	2020/07/21 11:33:55
Time Between Automatic Updates	1 Hour ▾
Time Server	time.nist.gov ▾ Edit Update now
Time Zone	(GMT-6:00) Central Time (US & Canada) ▾ Relative to GMT Apply
System Time	2020/07/21 11:33:42 (yyyy/mm/dd hh:mm:ss) Apply

Daylight Saving Time	
Using Daylight Saving Time	Disable ▾
DST begin	3 8 2 (mm/dd/hh)
DST end	11 1 2 (mm/dd/hh) Apply

Auto Restart System	
Auto Restart System Every	0 minute(s) ▾ 0 = Disable Apply
Manually Restart the System	Apply

i. **System Time**

System Time	2013/03/25 16:32:13
Time Between Automatic Updates	1 Hour
Time Server	time.nist.gov
Time Zone	((GMT-6:00) Central Time (US & Canada))
System Time	2013/03/25 16:28:31

System Time (yyyy/mm/dd hh:mm:ss)

This section is to manually set the IP Switch **System Time**. The format is pre-determined to: yyyy/mm/dd hh:mm:ss (in 24hr format). Click **Apply** to save the changes.

Time Between Automatic Updates

The user can set an interval for time synchronization. Select from either; none, 1, 3, 12 hours or 1, 10 & 30 days. *Default is 1 Hour.*

Time Server

Choose the nearest **Time Server** to your location. The user can choose from the list of a maximum of 30 Time Servers. To add a new **Time Server**, click **Edit**, delete an existing **Time Servers** from the list, then, the **Add** dialog box will appear. Click **Back** to return to the System Time Settings webpage.

Time Zone (Relative to GMT)

Select the appropriate time zone. Click **Apply** to save changes.

ii. **Daylight Saving Time**

Using Daylight Saving Time	Disable
DST begin	0/0/0 (MM/DD/HH)
DST end	0/0/0 (MM/DD/HH)

Using Daylight Saving Time

Disabled by default. Administrator can configure it to **AUTO** obtain Daylight Saving Time info OR **Manually** enter the DST begin and DST end dates.

iii. **Auto Restart System**

Auto Restart System Every	0	minute(s)	0 = Disabled
Manually Restart the System*			

Auto Restart System every XX minutes/ hours... (0 = Disabled)

Set the IP Switch server to automatically restart after a pre-set interval. This will reset the server. The power supply to each individual outlet is not disrupted during the server restart process. Use this to guard against system freeze.

Manually restart the system

Click **Apply** to manually restart the system immediately.

4.2.8 Language

Use this section is to set the language interface.

Language

Interface

English
 Spanish

Mail

English
 Spanish

*Note: Setting preferences will not work if you have disabled cookies in your browser.

Apply Reset

i. Language

Choose the language for the Web UI and E-mails.

4.2.9 SMS

**This feature is NOT supported at this time.*

4.3 Log Information

4.3.1 Event Log

This section will log events that occurred on the IP Switch and categorize them.

Event Log Type All

Refresh Clear

Date / Time	Type	Event
2013/03/25 15:44:06	Notification	Test E-mail has been sent
2013/03/25 15:42:19	Notification	Test E-mail has been sent
2013/03/25 15:16:52	Notification	Test E-mail has been sent
2013/03/25 15:12:39	Notification	Test E-mail has been sent
2013/03/25 15:12:16	Notification	Connection to E-mail Server failed
2013/03/25 15:10:43	Notification	Connection to E-mail Server failed
2013/03/21 12:35:20	Status	Outlet2 Manual On
2013/03/21 12:35:20	Status	Outlet1 Manual On
2013/03/21 12:35:13	Status	Outlet2 Manual Off
2013/03/21 12:35:12	Status	Outlet1 Manual Off
2013/03/20 12:09:09	Notification	Server address www.yahoo.com unresolvable
2013/03/15 05:23:46	Status	Outlet2 Auto On
2013/03/15 05:23:36	Status	Outlet1 Auto On
2013/03/15 05:23:34	Status	Outlet2 Auto Off
2013/03/15 05:23:34	Status	Outlet1 Auto Off
2013/03/15 05:23:33	Status	UIS 1 Reset
2013/03/15 05:13:41	Status	Outlet2 Auto On
2013/03/15 05:13:31	Status	Outlet1 Auto On
2013/03/15 05:13:29	Status	Outlet2 Auto Off
2013/03/15 05:13:29	Status	Outlet1 Auto Off
2013/03/15 05:13:28	Status	UIS 1 Reset
2013/03/14 10:21:02	Notification	Server address www.yahoo.com unresolvable
2013/03/14 10:05:18	Status	Outlet2 Manual On
2013/03/14 10:05:08	Status	Outlet1 Manual On
2013/03/14 10:05:06	Status	Outlet2 Manual Off
2013/03/14 10:05:06	Status	Outlet1 Manual Off
2013/03/14 10:04:59	Status	UIS On
2013/03/14 10:04:54	Status	UIS Off
2013/03/14 10:04:36	Status	Outlet2 Manual On
2013/03/14 10:04:31	Status	Outlet2 Manual Off

Event Log Type

Select which type of log to show:

- All (both Status and Notifications are shown)
- Status

Examples of Status logs:

UIS On/Off; Outlet Manual On/Off; Outlet Auto On/Off; UIS 1/2 resets.

- Notification

Examples of Notification logs:

Server address 'xxx' is unresolvable; Test email sent; Connection to Email

Server failed.

***NOTE:** If the System Time is not set up correctly, the event log may display a generic '2000/01/01' in the Date/ Time area. Once the System Time is synchronized, it will update all the Event Log times.

4.4 Help

4.4.1 System Status

This webpage displays System Status Information.

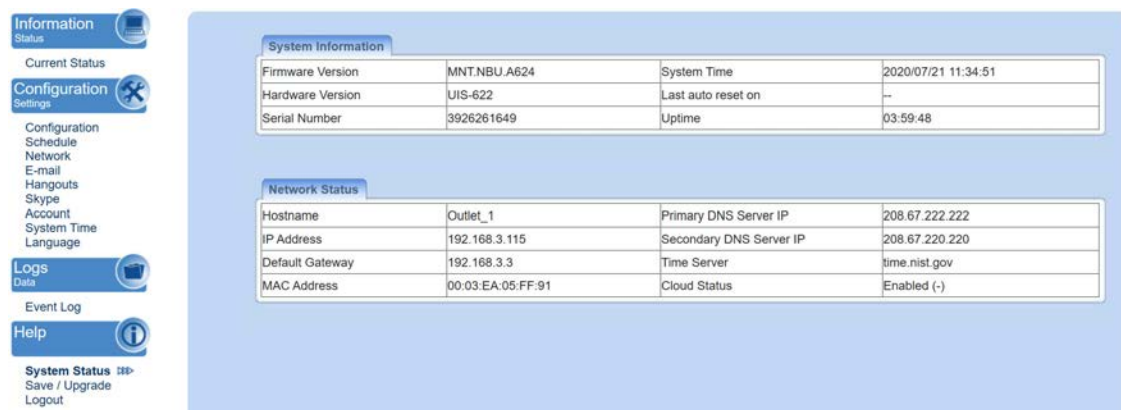

The screenshot shows a web interface with a left sidebar and a main content area. The sidebar contains navigation links: Information Status, Configuration Settings, Logs Data, and Help. The main content area displays two tables: System Information and Network Status.

System Information			
Firmware Version	MNT.NBU.A624	System Time	2020/07/21 11:34:51
Hardware Version	UIS-622	Last auto reset on	--
Serial Number	3926261649	Uptime	03:59:48

Network Status			
Hostname	Outlet_1	Primary DNS Server IP	208.67.222.222
IP Address	192.168.3.115	Secondary DNS Server IP	208.67.220.220
Default Gateway	192.168.3.3	Time Server	time.nist.gov
MAC Address	00:03:EA:05:FF:91	Cloud Status	Enabled (-)

i. **System Information**

This section shows general hardware information such as the Hardware and Firmware Version, the serial number, Uptime, System Time and when the system last reset.

ii. **Network Status**

This section shows all information relating to the Network environment.

Hostname

This is the default hostname. User can rename this by browsing to *Configuration* → *Network* page.

4.4.2 Save / Upgrade

The administrator can use this section to check/ upgrade firmware, save/restore settings, and factory reset.

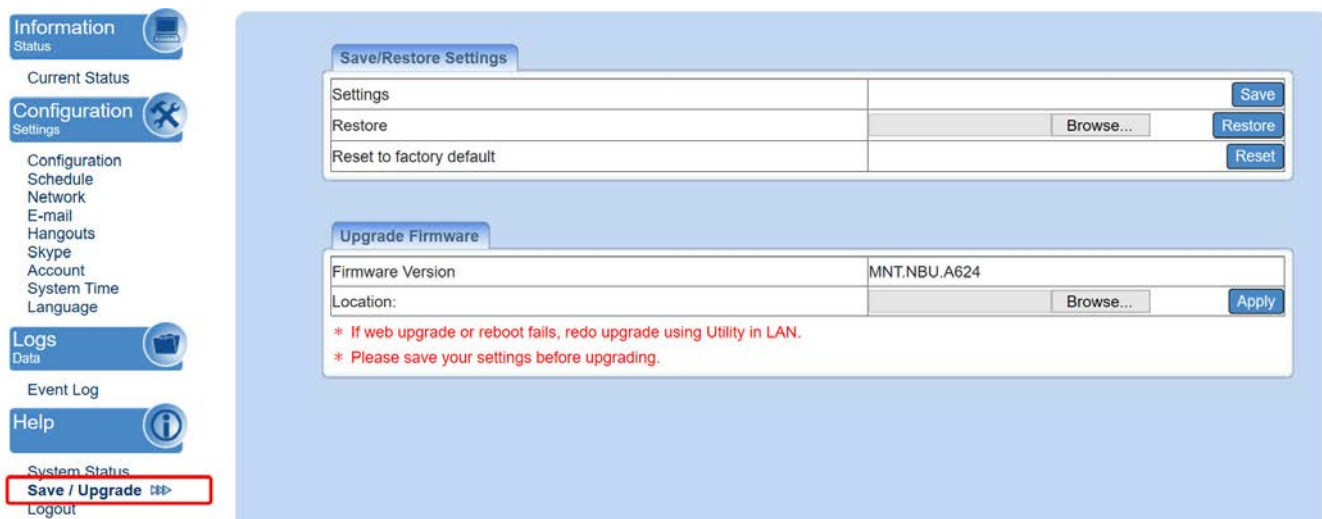

i. **Save / Restore Settings**
Settings

Click **Save** to save the configuration to your PC. The text file will have a default format of **SettingsYYYYMMDD.cfg**.

Restore

Use this function to restore a *.cfg configuration. Click **Browse/ Choose File** and locate the file you saved. Click **Restore** to apply.

Reset to factory default

This function will reset all settings to its default configuration.

ii. **Upgrade Firmware**
Firmware Version

Displays the current firmware version running on the Switch.

Location

This is where you would will select a firmware file to upgrade/ flash to the Switch.

4.4.3 Logout

Click to logout of the web interface.

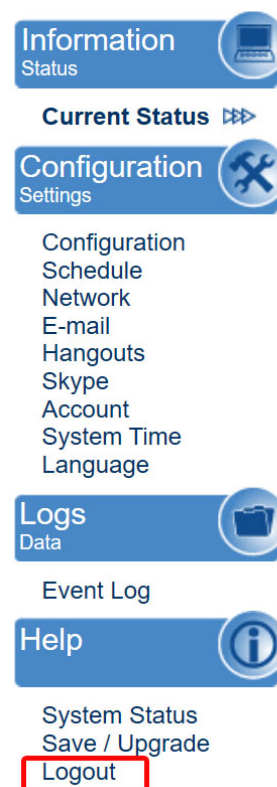

Chapter 5: Troubleshooting Tips

5.1 Common Issues

1. **Assign a static IP (manual) address to the Power Switch** rather than using DHCP.
 - a. This is a more stable/reliable way of connecting the Switch to your network
 - b. To configure this, you may do so from the WebUI (see **section 4.2.3**) OR via the Utility program:
 - i. Open **Utility** and search for the Switch (click 'refresh list' if not appearing) – **NOTE:** *If it does NOT appear, make sure that you are connected to the same physical LAN. This will not work if you are connecting through a VPN. Having anti-virus software of restricted admin privileges on the computer may also prevent Utility from locating the Switch.*
 - ii. Once found, select the '**Network Settings**' button. A window will open.
 - iii. In the IP address tab select '**Use the Following Static IP address.**' Enter an IP address within the same subnet to your PC. **Example:** If your router's default LAN/gateway IP is 192.168.0.1, you can use an IP address of: 192.168.0.10 (or something outside the DHCP range) and subnet mask of 255.255.255.0. Gateway is 192.168.0.1
 - iv. Click OK to apply.
2. **Ensure the UIS function is enabled and Internet light is illuminated.**

Without UIS enabled, the Switch will not know to monitor the connection. You also need to make sure the Switch is receiving an Internet connection, or else it won't be able to ping web addresses to verify the connection status
3. **Check your Configuration settings.** Specifically, the '**Timeout Settings**' & '**Outlet Setup.**' For users who have a separate modem and router plugged into each port: Typically, you want the modem to power up completely and connect to the Internet prior to the router powering on. We normally recommend at least a 1 minute delay. ***SEE: 'Ping Delay After UIS reset' AND 'Power-on delay for Outlet 1/ Outlet 2.'**
 - a. Also, to avoid too many timeouts due to a slow Internet connection, try adjusting **Timeout Settings** to a higher interval than default. In most cases, you'll need to experiment with settings to see what works best.
4. **Check your router for a setting such as: 'Block ICMP Ping' OR 'Block WAN ICMP Ping'.** Most routers from ISPs have built in firewalls, meant to protect from malicious activity and outside intrusion, but these built in firewalls can also block devices from functioning properly when connected to the network. A common feature, "Block ICMP Ping", is typically set to 'Enable,' meaning the router will block the response back to the IP Switch. This means the switch can never properly manage your Internet connection. Depending on your router, this feature can be found in different places, and take a variety of different names. For most users, the IP Switch works just fine with no extra configuration required.

5. Check the Fuse: If your IP Switch is not powering ON, it's possible the fuse may be bad. Follow the steps below to change out the fuse:

- a. Unplug the Power to your IP Switch before proceeding. Locate the Fuse Holder on the same side the power cord is attached.



- b. To remove, take something like a flat tipped screwdriver then push the fuse holder in slightly while simultaneously twisting to the left (in the direction of the arrow on the holder). The holder will pop out. Simply slide it straight outward.



- c. Once removed, it will look like this:



- d. When replacing the fuse, one end may sit more snugly than the other – put this end into the holder. Next, slide the holder with fuse end first into the IP Switch. Again, you will need to push slightly and twist, this time to the right.

6. **How to Confirm Auto Reset function is working:** In order to simulate an outage [to make sure the Switch is resetting properly] unplug the Ethernet cable from the WAN port of your router. OR, if you have an all-in-one modem/router, unplug the cable that's connecting your cable or DSL line to the modem/router. If you simply remove the LAN cable from the Switch itself, (which is the incorrect way of testing), then the timeout is detected based on **"Set Ping Frequency"** multiplied by **"Number of Continuous Timeout"**. The system will ignore **'Timeout based on Website / IP Address'** as it's not relevant anymore.
7. **My Switch does NOT reset when connection is lost:** Refer to **"Timeout Settings"** in **section 4.2.1**. Take the larger of either **"Timeout for Each Website / IP Address"** or **"Set Ping Frequency"**, and multiply that with **"Number of Continuous Timeout"**. This will be for the first **"Auto Reset"** time. From the second **"Auto Reset"** onwards, **"Ping Delay After UIS Reset"** will determine the time. *Default is 5 min after.*

NOTE: *The test of 'UIS Reset' time will depend on how the user simulates a failure. If the WAN cable is unplugged, the user will observe the calculation above. The Internet LED will turn Off, when there is no internet, at that point, the UIS Reset will kick in at the same time. For reference, Internet LED will not turn OFF the moment of timeout. This is because 'Timeout' is determined as a collection of 5 of websites (if any one website is still responding, the LED will blink), and is based on the above 'timeout settings'.*

5.2 Hangouts

If you receive an error when trying to get your IP Switch Gmail account to sign in (i.e. errors #501 or #20512), please try the following:

1. Log into the Gmail account through a web browser and confirm there is no 2-step verification set - OR, if it is, confirm you have the proper **App Password** entered. If you are NOT using 2-step verification, you will also need to confirm the “**Allow Less Secure Apps**” option is turned **ON**. These are both found under the “**Manage your Google Account**” -> “**Security**” section of Gmail.
2. Wait at least 5 minutes while the Switch tries to Sign In. It will go back and forth between signing in and showing the connection error.
3. Turn the **Status** on the Hangouts Settings to **Offline** then click **Apply**. Log into the Gmail account through a web browser and turn the “**Allow Less Secure Apps**” option **OFF**, then sign out of the account. Next, sign right back in and turn the “**Allow Less Secure Apps**” option back **ON**. Sign out of the browser. Lastly, go back to the Hangouts settings on your Switch and change the **Status** to **Online**. Click **Apply**. Wait a few minutes while the Switch tries to connect.
4. If you're still not getting the sign in or chats to work, some users have had success reloading the firmware, if current. You may download current firmware here: <http://www.networktechinc.com/control-power-reboot.html#tab-4>

If you are NOT receiving the Test Message (aka Chat Invite) from the IP Switch account, please do the following (*NOTE: If your Gmail does not show the information below follow the steps after the screenshot below step 8 here*):

1. Log into the Gmail account you have entered under **Contact Accounts**. Make sure that you are NOT logged into the IP Switch Gmail account on any devices.
2. From the **Inbox** page, look to the bottom left corner and you should see the following icons:  Select the one in the middle for **Hangouts**

NOTE: To use gmail for the IP Switch, user will need to allow less secure app access

3. You should see your name appear with a green dot next to it, which indicates you are signed into Hangouts. If you do NOT see this, there should be a button to “Sign in to Hangouts” – clicking this will sign you in
4. Click your **name** here and a menu should pop out
5. Click **Invites**
6. A new window will pop up and ask you to confirm you now want to allow people to contact you through Hangouts. Click **Ok, got it**
7. Another window will pop up showing your **pending invites**. Click this
8. In the Hangout chat window you will now need to click **Accept** to start allowing communication with the IP Switch

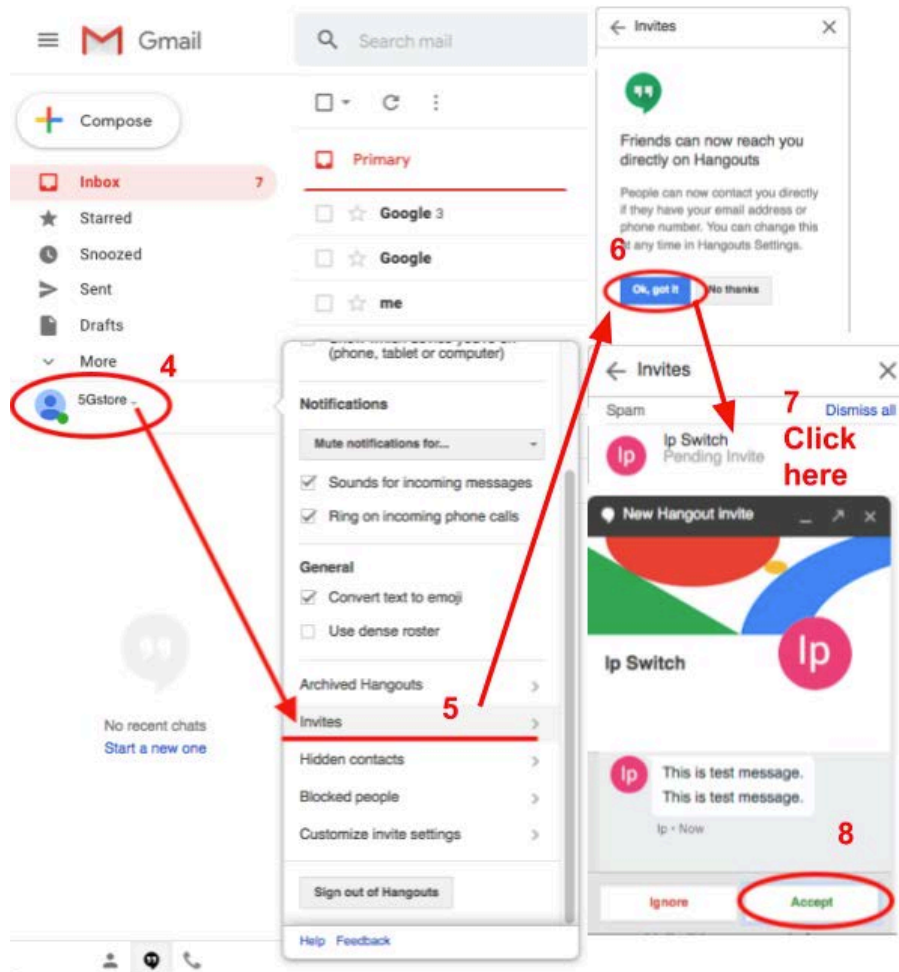

If you are no longer able to send commands to the Switch, check the following:

1. Check the users listed in the ‘**Contact Account**’ section. Only these users can control the IP Switch.
2. If you are removed from the Contact list, you will still be on the IP Switch’s contact list within the Gmail account, but you will need to re-add your Gmail address to the list via **Hangouts** configuration page (see **section 3.4.1**).

→ If you do not see the Hangouts and/ or Invites through the Gmail Inbox, access the Invites using the Hangouts app:

1. From the Gmail Inbox (for your **Contact Account(s)**), click the square dot button at the top right

2. In the list of apps that appears, scroll down and click **More**
3. Select the icon for **Hangouts** (or it may be listed as **Chat**)
4. A new window will open to the Hangouts app. You should see a menu on the left. Click **Invites**
5. Another window will pop up showing your **pending invites**. Click this
6. In the Hangout chat window you will now need to click **Accept** to start allowing communication with the IP Switch

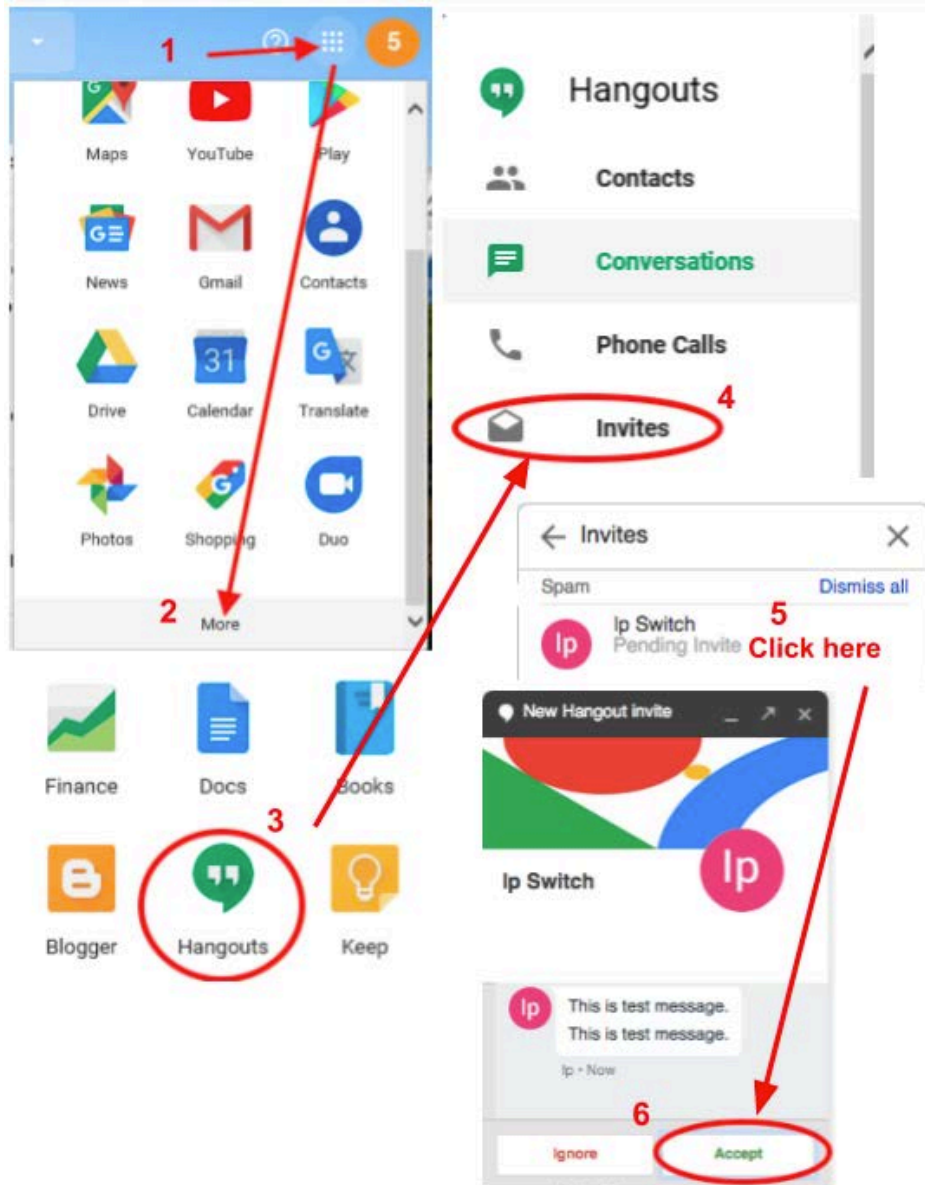

5.2.1 Using Accounts with 2-Step Verification

Due to compatibility, we suggest ensuring your IP Switch is running the latest firmware version. See **section 3.7** for instructions on how to upgrade firmware.

1. Go to <http://gmail.com> and select **Create Account**
2. For this example we are using ipswitch@gmail.com

To use gmail for the IP Switch, user will need to allow less secure app access

3. Click on the email account at the top right and a window will pop out
4. Click **“Manage your Google Account”** button
5. A new window will open showing **Google Account**
6. Select **“Security”** on the left
7. Scroll down to the **“Signing in to Google”** section
8. Confirm that **2-step Verification** is **Off****
9. Scroll down to the **“Allow less secure apps”** section
10. Turn this setting **On**

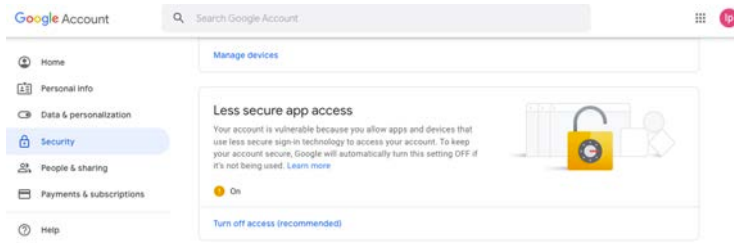

11. You may now close the **My Account** window and sign out of on the Gmail Inbox page

****Step Procedures with 2-Step Verification:**

If you prefer to have 2-step Verification turned ON, skip steps 9-11 above and continue with the additional steps below:

1. Scroll down to the **“Signing into Google”** section and select **“2-step Verification”**
2. Google will walk you through the steps to add a cell phone number for verification. It will send a code you will need to enter into the Gmail browser to **verify**. Once this is done, it should show 2-step Verification is **ON**.
3. Next, go back to **“Manage your Google Account”** -> **“Security”** -> **“Signing into Google”**
4. Select **“App Passwords”**
5. Click **“Select Device”** and choose **“Other (Custom Name)”**
6. Give it a unique name to identify it, here we’ve used **“IP Switch”**
7. Click **“Generate”**
8. Copy/ write the App password down (*see below right*), as you will need it to enter into the IP Switch later, then click **“Done”**

